

OHM'S LAW

$$E = I \times R$$

$$R = \frac{E}{I}$$

$$I = \frac{E}{R}$$

CONDENSERS IN SERIES

$$C_{TOTAL} = \frac{C_1 \times C_2}{C_1 + C_2}$$

RESISTANCES IN PARALLEL

$$R_{TOTAL} = \frac{R_1 \times R_2}{R_1 + R_2}$$

25c [^{30c} in Canada]

JANUARY, 1935

\$3.00 PER YEAR BY SUBSCRIPTION

RADIO

ESTABLISHED 1917

SHORT-WAVE AND EXPERIMENTAL

BOTTOM VIEWS OF SOCKETS

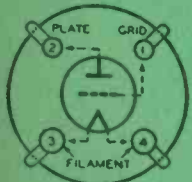

4-PRONG SOCKET
50-201-A, 45, 210, 30, 31, ETC.

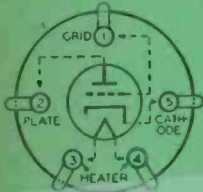

5-PRONG SOCKET
56-46-47-76-27-27

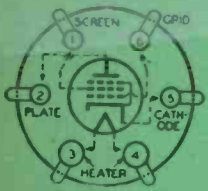

6-PRONG SOCKET
2A5-41-42-43

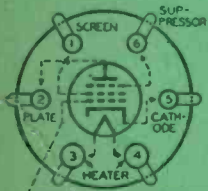

6-PRONG SOCKET
57-58-6C6-6D6-77-78

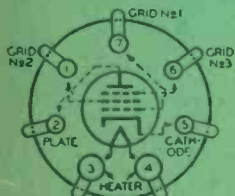

7-PRONG SOCKET 59

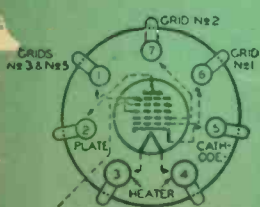

7-PRONG SOCKET
2A7-6A7

- IN THIS ISSUE -

The First Practical 5-Meter Superheterodyne
A Link-Coupled High-Frequency Receiver
Complete Data on New RCA-802 Pentode
High-Fidelity Audio Amplifier Problems
Hum-Free Pre-Amplifiers for Amateur Phone
Mercury Vapor Rectifier Tube Considerations



Frank C. Jones' 5-Meter Superheterodyne —the First Workable Receiver of Its Kind. See Page 8.

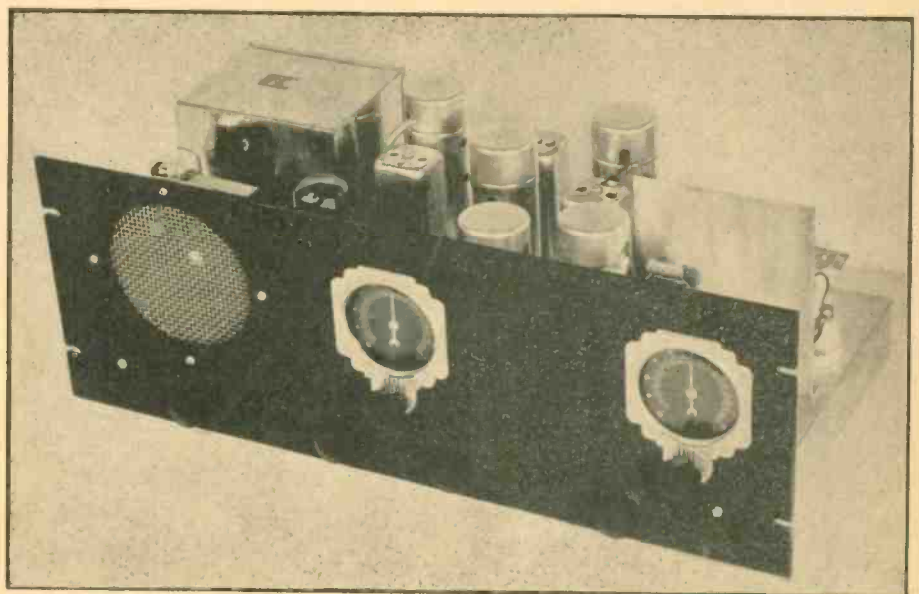

FEATURE ARTICLES BY...

CLAYTON F. BANE - FRANK C. JONES - COL. C. FOSTER
 J. N. A. HAWKINS - - FRANK LESTER - - I. A. MITCHELL

"WE USE 'EM AND LIKE 'EM"

Sylvania GRAPHITE ANODES

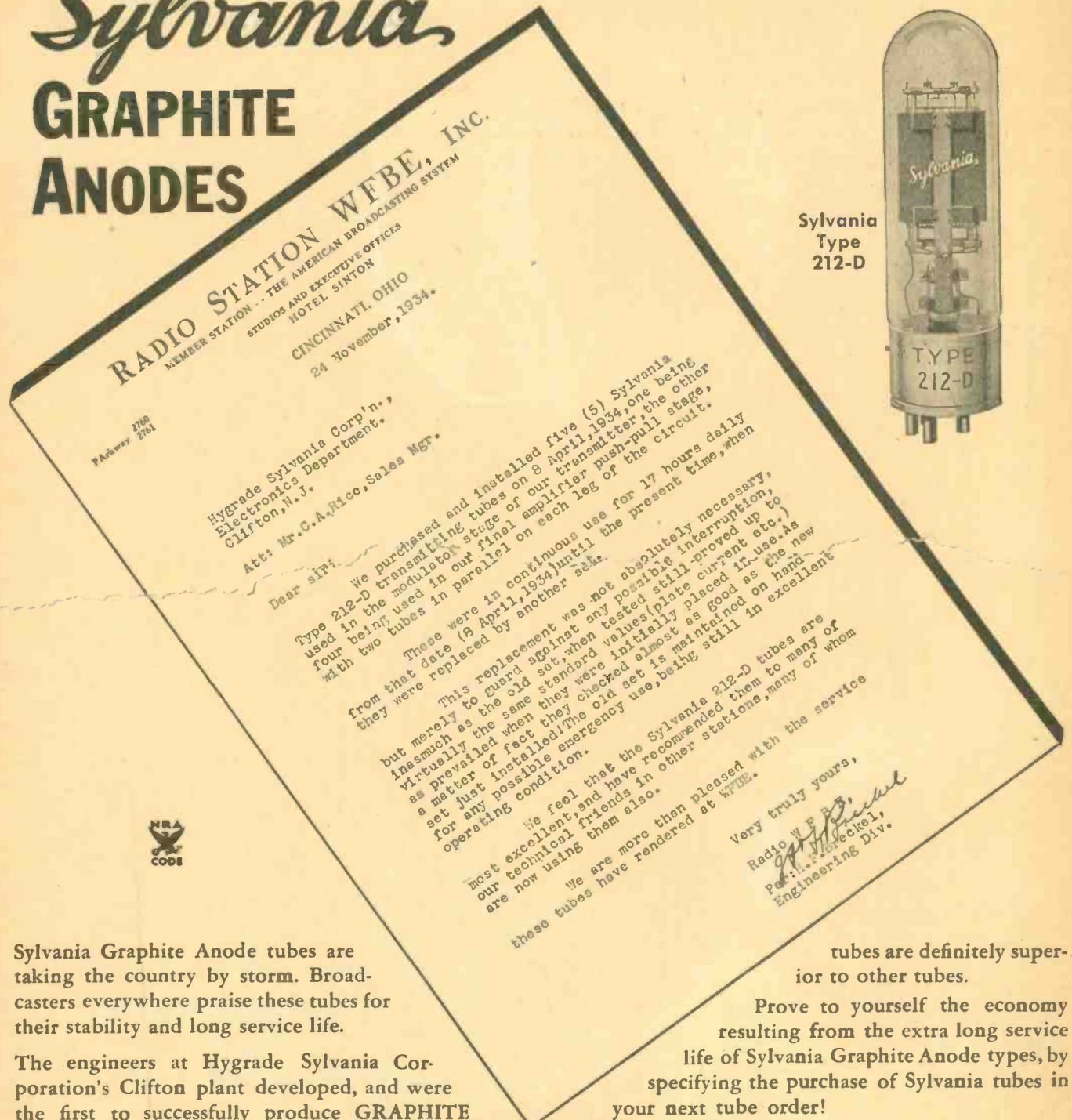

Sylvania
Type
212-D

RADIO STATION WFBE, INC.
MEMBER STATION - THE AMERICAN BROADCASTING SYSTEM
STUDIOS AND EXECUTIVE OFFICES
HOTEL SINTON
CINCINNATI, OHIO
24 November, 1934.

Package 2100
2101

Hygrade Sylvania Corp'n.,
Electronics Department,
Clifton, N. J.
Att: Mr. C. A. Rice, Sales Mgr.

Dear Sir:

We purchased and installed five (5) Sylvania Type 212-D transmitting tubes on 8 April, 1934, one being used in the modulator stage of our transmitter, the other four being used in our final amplifier push-pull stage, with two tubes in parallel on each leg of the circuit. These were in continuous use for 17 hours daily from that date (8 April, 1934) until the present time, when they were replaced by another set.

This replacement was not absolutely necessary, but merely to guard against any possible interruption, inasmuch as the old set, when tested still proved up to as prevailed when they were initially placed in use. As a matter of fact they checked almost as good as the new set just installed! The old set is maintained on hand for any possible emergency use, being still in excellent operating condition.

We feel that the Sylvania 212-D tubes are most excellent, and have recommended them to many of our technical friends in other stations, many of whom are now using them also. We are more than pleased with the service these tubes have rendered at WFBE.

Very truly yours,
Radio W F B E
Paul F. Foye, Chief
Engineering Div.



Sylvania Graphite Anode tubes are taking the country by storm. Broadcasters everywhere praise these tubes for their stability and long service life.

The engineers at Hygrade Sylvania Corporation's Clifton plant developed, and were the first to successfully produce GRAPHITE ANODE tubes. There is no doubt in the mind of the keen, up to the minute broadcaster that these

tubes are definitely superior to other tubes.

Prove to yourself the economy resulting from the extra long service life of Sylvania Graphite Anode types, by specifying the purchase of Sylvania tubes in your next tube order!

The type 212-D has gone over big! The letter above tells the story. Can we say more?

© 1934 H.S.C.

HYGRADE SYLVANIA CORPORATION

Hygrade Lamps ELECTRONICS DEPARTMENT, CLIFTON, N. J. Sylvania Tubes
 FACTORIES: SALEM, MASS. EMPORIUM, PA. ST. MARYS, PA. CLIFTON, N. J.
 WAREHOUSE STOCKS IN: Portland, Ore.; Atlanta, Ga.; Denver, Col.; Chicago, Ill.; Salem, Mass.; Dallas, Texas; Philadelphia, Pa.; Pittsburgh, Pa.; Los Angeles, Cal.

HAMMARLUND

CHOKES are BETTER

BETTER in Design,
Mechanical
Construction,
Electrical
Features !

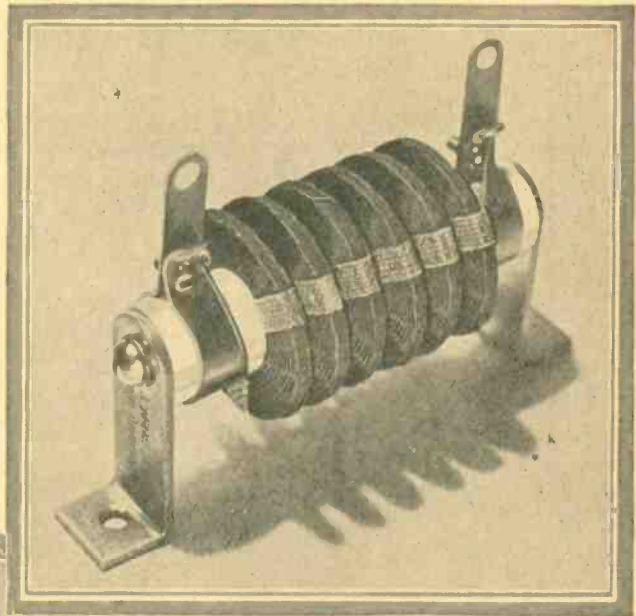

"CH-500" TRANSMITTER CHOKE

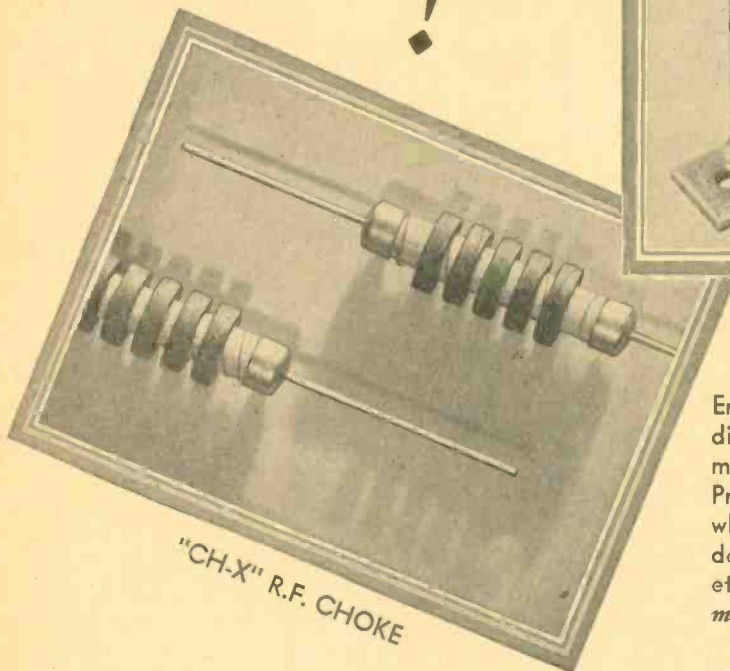

"CH-X" R.F. CHOKE

End caps are small, thin and so spaced that distributed capacity to adjacent coils is at a minimum. Inductance 2.1 mh. Isolantite core. Priced so low it can be used generously wherever R.F. filtering is desirable—such as detector plate circuits, all B+ leads, grid leads, etc. Only 75c each, less 40% to experimenters.

The Hammarlund "CH-500" Heavy-Duty Transmitter Choke delivers its highest useful impedance (*more than 500,000 ohms*) precisely where wanted—at the 20, 40, 80 and 160-meter amateur bands. Inductance 2.5 mh. Distributed capacity less than 1.0 mmf. DC resistance 8 ohms. Maximum recommended DC (*continuous*) 500 milliamperes. Isolantite core, with *no metal through center*. Mounts with a single machine screw, with brackets removed. \$1.75, less 40% to experimenters.

DON'T be misled by similarity of appearance or claims. Know the FACTS! HAMMARLUND Chokes have been *proved* different and better in all essential qualities. As evidence, the Hammarlund "CH-X" is the smallest and lightest R.F. choke made. Its features are *exclusive*. Only 1/2" x 1 1/2", it is small enough for restricted spaces, and so light that the tinned copper leads are ample support. Leads extend *straight* from the end caps. This makes for neater wiring.

Mail Coupon for Details



HAMMARLUND MANUFACTURING CO.,
424-438 W. 33rd St., New York

..... Check here and attach 10c for 16-page Hammarlund 1935 Short-Wave Manual, illustrating and describing most popular S-W circuits of past year, with schematic and picture diagrams and parts lists.

Check here for FREE information on Hammarlund Chokes.

Check here for FREE 1935 General Catalog.

Name.....

Address.....

PR-1

Greater Power with GRAPHITE ANODES

The cooler operation of Amperex Power Tubes—because of the greater surface and black body radiation of the Graphite Anodes results in longer life and greater power output.

LIST PRICES OF AMPEREX TUBES

800	\$10.00	*211H	\$ 17.50	852	\$ 22.50
801	5.00	212E	75.00	860	35.00
203A	15.00	242A	12.50	864	1.50
*203D	17.50	264B	1.75	865	12.50
204A	95.00	276A	17.50	866	4.00
205D	5.00	830	8.75	866A	5.00
210	2.50	841	3.25	872	15.00
211	12.50	842	3.25	872A	17.50
*211C	15.00	845	17.50	869	165.00
*211D	17.50	849	160.00	869A	165.00

*New High Frequency Tubes

Recent development work in the Amperex Laboratories has resulted in the perfection of several types of tubes particularly suitable for high frequency work in the Physio-Therapy and Diathermy fields, as well as for the amateur experimenter. These tubes, although in outward appearance and dimensions equivalent to 50 watt types, will in properly designed circuits deliver R.F. power outputs as high as 250 watts.

AMPEREX ELECTRONIC PRODUCTS, INC.

79 Washington Street

Brooklyn, N. Y.

DISTRIBUTED BY

E. C. WENGER CO., Oakland, California
 SAN FRANCISCO RADIO EXCHANGE, San Francisco, Calif.
 RADIO TELEVISION SUPPLY CO., Los Angeles, California

AMPEREX
 Power Tubes •

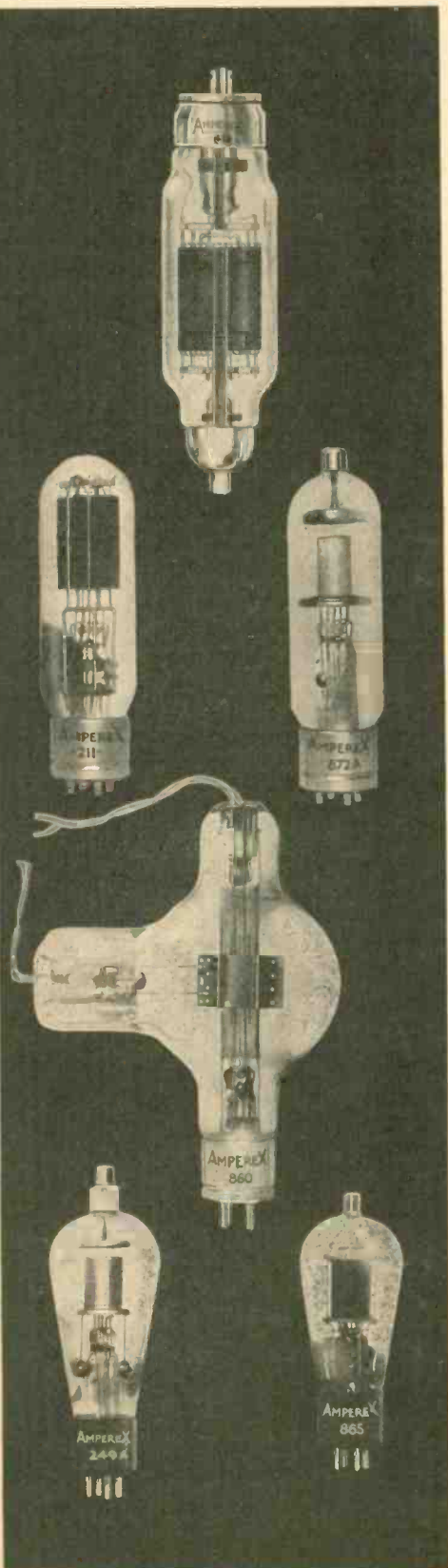

BRANCH OFFICES:
 New York City,
 253 W. 128th St.
 Tel. MOnument 2-2812
 Boston,
 J. H. Condon,
 6 Marlboro St.
 Chicago,
 C. W. Nelson,
 3618 North Bernard St.
 Los Angeles, Calif.
 1455 Glenville Drive.
 Tel. CRestview 4017

RADIO

ESTABLISHED 1917

Reg. U.S. Pat. Off.

A NATIONAL MAGAZINE PUBLISHED MONTHLY

Publication Offices—Pacific Building, San Francisco, California

Clayton F. Bane, Editor
 H. W. Dickow, Business Manager.
 D. B. McGown, Technical Editor. Frank C. Jones, Ultra-Short-Wave-Engineering Editor.
 Clair Foster, Amateur Activity Editor. George B. Hart, Contributing Editor.
 C. C. Anderson, Engineering Draftsman

25c per copy, \$3.00 per year by subscription in the U.S. \$4.00 elsewhere. Send subscriptions to the San Francisco office. Entered as second class matter at the Post Office at San Francisco, California, under the Act of March 3rd, 1879.

Vol 17

JANUARY, 1935

No. 1

RADIOTORIAL COMMENT

Worthwhile New "Q" Signals

WHEN an amateur CQs on the high-frequency end of the band it is generally assumed that he covers only that portion of the band when listening; he seldom goes beyond the middle of the dial. Thus those whose transmitters are tuned to the low-frequency end of the band are not often recognized by the high-frequency CQer, simply because he never gets to the other end of the band. Or vice versa.

A dyed-in-the-wool DX hunter covers his choice end of the band with great care, tunes slowly and depends upon his old acquaintances to answer his CQs. But the newcomer and the man who calls CQ for the purpose of raising anybody, anywhere in the band, has a different problem on his hands. Sometimes he starts to tune from the high-frequency end, sometimes from the other end. So that those who hear a CQ will know which end of the band the CQer will cover when he throws his switch to the receiving position, it is suggested by Art Bates of the CALL BOOK that a few new "Q" signals be added to the list. The suggestion is timely, should appeal to all good amateurs. Here are the proposed new signals:

QHM . . . I will begin listening at the high frequency end of this band, tuning towards the middle of the band.

QLM . . . I will begin listening at the low frequency end of this band, tuning towards the middle of the band.

QMH . . . I will begin listening at the middle of this band, tuning towards the high frequency end.

QML . . . I will begin listening at the middle of this band, tuning towards the low frequency end.

Although Mr. Bates has already sent these proposed new "Q" designations to various domestic and foreign radio magazines, it has been suggested by a staff member of "RADIO" that the new signals be reduced to two in number, i.e., one signal to indicate that the operator is tuning from the high frequency end of the band towards the middle, and another signal indicating that he will tune from the low frequency end of the band towards the middle. QLO would indicate, "I start tuning from the low frequency end." QHY would indicate, "I start tuning from the high frequency end."

Thus only two new signals would be added, both self-evident in character, the "LO" portion of the "Q" signal automatically means "LO Frequency" and "HY" means "HIGH Frequency." 'Twould be better to make it QHI instead of QHY, but for the laugh that HI has associated itself with.

An expression from the reader is asked for. Quick action is needed so that the new signals will be widely known and used when the next international tests are with us. Do you favor four new "Q" signals as suggested by Bates, or only two new signals—QLO and QHY—as suggested by "RADIO"?



Thank You, Ever So Much!

THE destiny of amateur radio is in the hands of Congress," you were told by the Political Editor in December "RADIO." And a flood of letters from subscribers—far too many to answer individually, are stacked high in the editor's files. How to approach a Congressman? That's easy. Colonel Foster will present the plan in full in the next issue of this magazine. If you are seriously interested in the future welfare of amateur radio, you will



Uncle Sam to Amateur Radio Spokesman:
 "If it's more privileges you want, why not come up and see ME sometime?"

heed his timely advice and join the vast army of amateurs who have already pledged themselves to leave no stone unturned to prevent the frequency-grabbers from ultimately putting V-wheels on sacred amateur territory.

Fortunately for the amateur, the President of the United States is a man of vision. Every amateur is ready to back him in the event of national emergency. We are going to ask him to back us, without a penny of cost to

our Government or to our people, so that we will still be AMATEURS when the time of need arrives. If you thrive on fact, not fancy, you will find a lot of it in next month's "RADIO." Colonel Foster knows Washington and Washington knows Foster. Thus the constructive program of telling the amateur what to do and how to do it will be presented with full vigor in the months to come.



The First Successful 5-Meter Super

ELSEWHERE in these pages you read what Frank C. Jones has accomplished in the form of 5-meter reception via the super-heterodyne route. Again, necessity was the mother of invention. The 5-meter band is already overcrowded in many of the larger metropolitan areas. The super-regenerative receiver must soon give way to inexpensive forms of 5-meter super-hets. Until this time there has not been available a WORKABLE super for the ultra-high frequencies. The latest achievement of Frank C. Jones will be welcomed by experimenters, manufacturers, jobbers and retailers.

May this latest contribution to the art bring you greater pleasure and more thrills from your 5-meter experiments.

TALKING about Frank C. Jones, turn back the pages of "RADIO" to 1925. Nine years ago, Jones was at work in his laboratory, conducting a series of transmitter amplifier tests. The amplifier was coupled to the antenna by means of two wires. Accidentally, Frank Jones moved the feed wires closer together, found that the output was increased. Thereupon he twisted the two wires together and observed a marked increase in antenna current. And so "Link Coupling" was discovered. Unquestionably, this form of coupling has played one of the major roles in modern amateur practice; it seemed reasonable to assume that Link Coupling could also be applied to receiving equipment. Consequently, Frank Jones went to work to find out what would happen when an antenna is link-coupled to a detector circuit. Also in these pages is an article from his pen, telling how to build a marvelous little amateur superheterodyne receiver which uses this new form of antenna coupling. If you like to "roll your own," here is your opportunity to build a receiver that is literally a hair-raiser. Thus "RADIO" starts the new year right, with a pair of editorial scoops that should be welcomed by all. The technical standard of the magazine will be vastly improved during 1935. It will be an exciting year for the radio amateur.

A Deaf Mute Asks for an Amateur License

★ If this story does not make your heart throb, you are not worthy of the name "amateur". For here is an appeal to every radio amateur in the United States to do his small part in helping Mr. Adolph Czajka of Chicago in his efforts to secure an amateur license. Petitions from radio clubs should be sent directly to the Federal Communications Commission at Washington.—Editor.



Adolph J. Czajka at the tape recorder. He will send you a piece of the tape on request.

TOTALLY deaf, he hears all over the world. Mute, he understands the language of the far places. In thirty-six countries of the globe his name is known but his voice has never been heard. And now 15,000 persons are asking Washington to abrogate federal regulations in order that he may have a tongue. Introducing: Adolph J. Czajka, deaf mute radio operator of 2428 West 34th Place, Chicago, Ill.

Adolph is one of the world's most remarkable people. Totally unable to hear a sound he is a first-class radio operator. In his humble home where he sits through the long nights, and silent days, he has 900 QSL cards from "hams" from all over the world. He has never heard a signal from any of their stations. In place of ears that will not function, Adolph uses his eyes—that and a recorder of his own design.

Adolph "sees" radio signals. Incoming continental is logged on a tape and becomes to this man who lives in a world of silence, living speech from the outside world. Thirty—forty words a minute his little chattering recorder plods away and through it Adolph Czajka knows the gossip of the air-planes. He saves his tape and sends it to fellow hams so they may see a picture of their sending—good or bad. And they thank him for it.

It is the great dream of Adolph's life to own a federal amateur license. Regulations provide that he must copy audible signals in order to be licensed as an operator. But a movement has been started by fellow operators to have federal regulations waived in his behalf. The need is imperative. Through radio a new world has been opened to this man who cannot hear and who must depend upon the lightning speed of his fingers for communication with others.

"I cannot be without my radio", he writes on his typewriter, with a world of pent-up feeling behind the words. "I like very much to be radio ham or fan better than to go

around bums on the street. My wife says if I stay at home with my short wave receiving station I will be a good man."

And so Adolph stays home and listens to the world talk. There is the itch of brass in his fingers. He wants to talk back. He knows the code. He can handle a key. He knows how to build his transmitter. All he needs now is for Uncle Sam to temper

birthrights, Adolph years ago turned to radio and found there an electrical voice he could see with his eyes. Thereafter a new world was opened to him.

One of Adolph's friends—operator on the U.S.S. Pontchartrain at Norfolk, Va., wrote to him, expressing a hope that the federal body would grant him a license.

"We all think here it would be a dirty shame not to," he wrote. "You could have my ticket if there was any way of giving it to you. I know it would mean a lot."

Only Adolph Czajka knows what it would mean to break the radio silence of 12 years—to reach out, touch a key with hungry fingers and through the tiny spots on his recorder tape learn for the first time that his far-flung radio impulses had been received. To talk, in other words, for the first time in his life, through the necromancy of the new science that has linked the countries of the world in a new understanding.

That is the New Year's gift that radio hams of the United States are seeking for this undaunted hero of the air lanes through petition to official sources. How they feel about it is shown by some of the scores of letters in which fans express their thanks to Adolph for the real service he has done ham radio by his soundless check on transmitted signals. One from W8IZE at Clarke Summit, Pa., in point:

"Thank you very much for your tape recording of my signal . . . while examining the tap I notice I have a tendency to hold the last dash in '8' 'w' and 'z'. I am glad to know this and will try to correct that to improve my keying. Sure hope you are successful in obtaining a special license to operate. You ought to work fb with a tape recorder . . . 73."

From 9WL at Chicago came this one:
". . . fb on your building your own recorder. Your good work speaks for the

regulations with discretion—and help him get a license, even though he cannot hear. For without ears, he is better than most.

"I made my own first tape-recorder in 1925", he writes. "But it was only fair. It worked only 100 or 125 miles but it picked up 32 amateur radio stations. I changed it again in 1928, and picked up more than 100 amateur and commercial stations. I made it over again in 1931 and this time picked up 800 QSL cards from amateur stations. I have been a student twelve years in radio without a ticket."

Once he went up to get his ticket—his federal license. He was turned down because he could not hear. Now radio amateurs all over the country are signing a giant petition to have the license given to him. There are a number of blind operators working the ham lanes. Adolph believes he is just as good with his perfect eyes, even though he cannot hear or speak. So do his fellow hams and they are going to try to convince the federal communication commission of the fact.

Adolph's list of letters and acknowledgment cards is amazing. Letters from battle-ships, from commercial stations, from radio men all over the world. He has "heard" their signals by seeing them on his tape. He logs the station, writes it a letter, and enclose a tape record of the message. Hams, thousands of miles away have been astonished to receive from the Chicago deaf mute a photographic picture of their sending. For the first time they have had revealed a "rotten fist" as it showed on a recorder. Invariably they have written back to him sincere thanks.

These return letters—these 900 QSL acknowledgments are the salt of life to this man condemned to sit through the days and nights without the sound of his own children's laughter. For he has children—two of them "and a nice wife", as he himself describes her. Cheated of one of man's

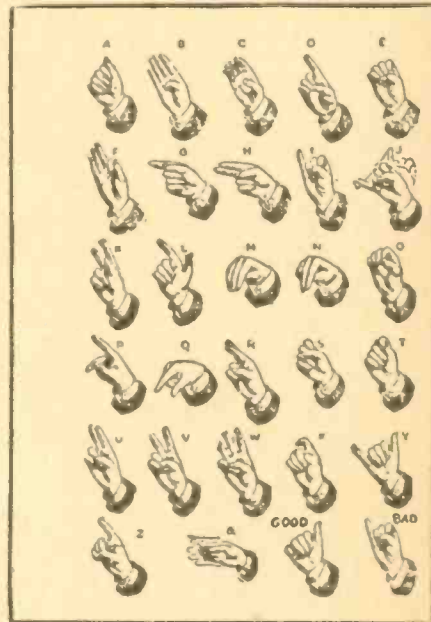

This—and the radio code are the only languages that Adolph Czajka knows. The illustration above depicts the "sign language" of the deaf mute. It was reproduced from his QSL card.

great interest that radio can stir up in people, surely handicapped as you are. I think it is marvelous. I hope you have good luck . . ."

From W8BCV at Detroit:
". . . I am writing a letter to the ARRL (Continued on page 18)

I Voted "NO"

By COL. C. FOSTER, W6HM

AT THE Fresno convention a motion was made to split the Pacific Division in two and make the southern half a new division. It was made by W. W. Matney, W6EQM, the ranking officer of the new little group with the new big name, "Federation of Radio Clubs of the Southwest, ARRL, a California Corporation". Generally speaking, resolving at ham gatherings is merely a form of pastime and about as futile as praying for rain in Death Valley. The accompanying arguments do, however, give us a chance to blow off steam. Some of us like to "debate", some of us blow tin whistles, some hammer out calls on the steam pipes. Some of us ease the pressure merely by "seconding" motions and casting votes in all directions—long, loud and often. As most pleasures are largely in their anticipation, we hams get ours from the pictures our wishes present in these "resolutions." The fact that their objects are seldom realized and always soon forgot takes none of the pleasure from the making of them.

We older hams who are more or less "sales-proof"—more or less immune to herd emotionalism—vote perfunctorily if we vote at all. We know perfectly well that when a ham assemblage votes to raise the power limit of stations it has just as much effect on the Federal Communications Commission as throwing stones at the moon. There is an intelligent and forthright way of getting more power for amateur stations but men of experience know that firing broadsides at ONE ANOTHER at hamfests will never get it.

But occasionally there appears a resolution that concerns only the machinery of the amateurs' own organization. Such movements do hold the possibility of bearing fruit—sweet or sour, as the case may be. This motion of the "Federation" to secede from the Pacific Division and force Southern California to become a part of a new division was of this nature—an internal ARRL affair. The younger element of the south had been well proselytized in advance, so there were many pairs of lungs under high compression with suppressed "Ayes". When the chairman called for these ayes the hall was filled with them. Surmising that there would be few "Noes" I put plenty of steam back of mine to make it go as far as possible. And I had the proud distinction of voicing the ONLY "no"! Perhaps "Ten thousand Frenchmen can't be wrong", but I'll swear that one hundred hams can—when well narcotized beforehand. I was asked if I would be willing to give my reasons for voting "no." I replied that I would do so in writing. I hereby do.

This plan of the Little ARRL, Incorporated, however sinister, is fairly easy of accomplishment, provided the Warner-Segal-Maxim combine desires it. That combine, the key man of which is Warner, controls a majority of the ARRL directors. It controls likewise the executive committee, all of the acts of which are invariably accepted by the ruling majority of the board as their own acts. Warner encountered no obstacles in throwing the Philippines out of the Pacific Division and actually disfranchising the Philippine members in 1930. This was done not only without the knowledge and consent of the Pacific Division but even without the knowledge of the Philippine members themselves! And the Philippines STAYED out until 1932—until Warner was apprised by the then director of this division that unless the Philippine members were restored to

their rightful status he and the directors would be taken into court and FORCED to put them back. Now, if Warner could engineer such a violation of all the canons of courtesy and justice as that he could as easily, with the backing of this resolution of the Little ARRL, Incorporated, remove Southern California and Utah, (or any other state), from the Pacific Division. In the Philippine case Warner made the mistake of keeping the project secret from the division members. I suspect that in the present case he is avoiding his former mistake by permitting the present plan to "originate" in an open meeting of Pacific Division amateurs—even though only 155 of the 536 registrants at this convention claimed membership in the ARRL. In which event he would have an alibi such as he failed to provide for himself in the Philippine case. History has a way of repeating itself and the amateur who is unacquainted with it or ignores its lessons is losing the greatest opportunity for seeing what is going on under the surface today.

The Little ARRL, Incorporated, is a federation only in name. The association of the amateur body with it is loose in the extreme. Its members are such of the southern clubs as have joined it. Its meetings consist of its officers and such "delegates" of the member clubs as put in an appearance. The rank and file of the clubs know little and care less of the inner workings of Little ARRL, Inc. The scheme is to make a small group appear to be speaking for a large body of amateurs—to make the Little ARRL, Inc., appear to be speaking for all the amateurs of Southern California, just as the Big ARRL, Inc., has conveyed the impression that it is composed wholly of amateurs and that it speaks for all the amateurs of the United States, while in fact it is composed largely of commercial radio people and other non-amateurs with only a small proportion of the amateurs of America in it. Its motivation is essentially the aim of a few men to dominate the amateurs of Southern California, regardless of how few may have any interest in either the Little ARRL, Inc., or the Big ARRL, Inc. However wholehearted may be the moving spirits of the Little ARRL, back of it all lies the aspiration to shine as IT.

It is common belief that this group of secessionists is a Warner outfit. There is much evidence to substantiate the belief. The character of correspondence between the group and the ARRL headquarters points to it. And last year when the San Jose Club—long villified by headquarters—sponsored the division convention, no headquarters man was sent to it—while not long afterwards when the newly hatched "federation" worked up a hamfest under its own name Warner sent his right-hand man, Budlong. The only instance of which I have heard of the ARRL's money being spent to send a man clear across the continent to a mere hamfest. At the Fresno convention it was again Budlong. Much of his time was spent in the company of officers of the Little ARRL. And after the convention he was again with them in and around Los Angeles. If Budlong had disapproved of the Federation's plan to disrupt the Pacific Division it is a cinch that Matney would never have offered his resolution. The plan must have had at least Budlong's tacit approval. It would not have had his approval without having Warner's approval. So much is certain; for with Budlong as with everyone else on Warner's staff he plays Warner's game or he loses his job.

And fat jobs aren't picked out of the bushes these days.

Officers of the Little ARRL definitely approved Warner's action in failing to report the truth of the Madrid convention. They approved of Warner's actions in Washington against the efforts of amateurs all over the country who were striving to prevent ratification of the new amateur restriction, thus providing the spectacle of a group of amateurs siding with the commercial element that had contrived the new restriction—the spectacle of Pacific Division amateurs approving a new restriction devised for killing the greatest continuous public service ever performed by the amateurs (and performed almost wholly by Pacific Division amateurs)—the trans-Pacific traffic. So when we call this group of secessionists a Warner outfit we do so with deep conviction.

The proponents of the secession plan had only two reasons to advance for it. They had some arguments besides, but when their talk was divested of inconsequential and irrelevant reasons boiled down to just two—(1), That Mr. Culver, director for the division, lives too far from them to come and see them as often as they would like, and, (2), That the ARRL members of the division are so numerous they cannot be properly represented by one director at the yearly meetings of the board.

As for No. 1—There are some wise, grown-up amateurs in Southern California, and in all the years of the Pacific Division's existence none of these men has ever intimated that a director residing in the San Francisco area was too far away. Anyone in any part of the division who wishes to confer personally with the director is welcome to do so. If a man wishes to see the director there is no reason why the director should always be the man to do the traveling. The director attends a number of important gatherings each year in different parts of the division. There is no reason why a director should attend every hamfest, nor does he—even in his own vicinity. If he had no better use for his time than running to hamfests all over the map he would not be exhibiting the common sense needed for a director. Perennial playboys and glad-handers don't make dependable directors. In all the history of the division no intelligent ham ever before kicked because the director resided approximately in the middle of the division. And just remember that Hawaii and the Philippines are also in the Pacific Division.

Claim No. 2 is wholly specious. The truth of the situation is that the secessionists don't like Culver. If they did, it would not have occurred to them that they themselves needed a different director. In their dislike for Culver they are disclosing either that they cannot recognize outstanding ability and character or else that they are taking their cue from someone else who doesn't like him. The ARRL headquarters does not like him; and for the sufficient reason that of all the directors at present on the board he and Director Jabs are the only two who are bent upon cleaning up the mess the ARRL is in. This is the common knowledge of discerning amateurs throughout the United States.

Just presume, for the sake of argument, that the secessionists had got their new division. They would, of course, expect to name a man of their own way of thinking as its director. Now, at the last meeting of the ARRL board, 14 of the 16 directors approved Warner's Madrid conduct just as did the secessionists; so the men of the Little ARRL, Inc., cannot well maintain that they need

(Continued on page 33)

The First Practical 5-Meter Super

By FRANK C. JONES
Ultra-Short Wave Editor

• The writer, in common with other 5-meter experimenters, has always had better luck with super-regenerative receivers than with any other type on the 5-meter band. An analysis of the situation brought out some interesting points, so another superheterodyne receiver was built and the results have been very gratifying. The sensitivity and selectivity of this receiver is better than any super-regenerative receiver that I have ever tested.

For present day purposes, a receiver must tune broadly enough to cover from 50

The RF stage provides a little additional gain where it is really needed, reduces image interference, and removes antenna resonance absorption spots from the regenerative circuit. This combination brings in 5-meter signals that are inaudible on super-regenerative sets using a stage of TRF. The same results were obtained in comparing it with an ordinary transceiver set.

wide maximum sensitivity, delayed AVC was used and this voltage applied to the grids of the two IF stages only. An audio volume control is used to maintain the desired amount of loudspeaker volume. The sensitivity control, a 50,000 ohm IF cathode variable resistor, could have been made 5,000 or 10,000 ohms with a slotted shaft for screwdriver adjustment only, since the usual field strength of 5-meter transmitters is quite low.

Examination of the circuit will show that the RF and detector circuits are quite similar to those used in longer wave sets. These two circuits are tuned by a gang condenser made from a couple of midget condensers. The condensers were originally 100 mmfd type and later were double spaced and only 7 plates left in each condenser. Double spacing helps on 5 meters since the condensers are less microphonic when the loudspeaker is being operated at good room volume. Trimming the detector and RF stage is accomplished by means of the semi-variable coupling condensers from the antenna to grid, and plate to grid of the respective stages. The coils were made of No. 14 wire so the inductances can be varied by slightly altering the turn spacing. No attempt was made to track the oscillator with the other two circuits, although this could probably be accomplished. Regeneration makes the detector tuning about as sharp as that of the oscillator.

The second detector and audio power stage is quite similar to that used in some broadcast receivers. Delayed AVC is obtained by using one of the diode plates biased with respect to the cathode. The signal must be of a certain amplitude before any negative AVC voltage is generated for AVC control. The audio frequency is taken from the other diode plate without any bias, since the latter would cause audio distortion. The high mu triode section of the 75 tube is used as a regular resistance coupled audio stage giving a gain of about 40 to 50. A type 42 pentode increases the signal to loudspeaker volume.

A tone control is provided to reduce automobile ignition interference which is quite serious when using a superheterodyne receiver in most locations. A high half-wave receiving antenna, transposed two wire feeders and an electrostatic shield should reduce

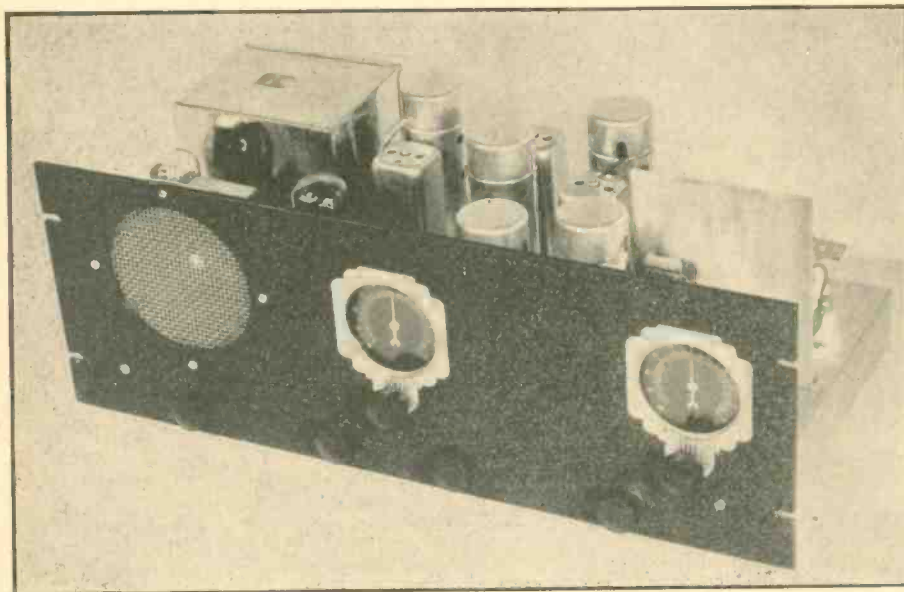

• The front panel presents a symmetrical and pleasing arrangement. The loud-speaker is protected with a metal grille. Illuminated Crowe airplane tuning dials add beauty to the job. The panel is of standard relay rack.

to 100 KC band width in order to receive the usual modulated oscillator transmitter signals. Very few stations use crystal or MOPA controlled sets and thus a special IF amplifier was built using a short wave about 110 meters for the intermediate frequency. This, with close coil coupling, gave a nice band width and the superheterodyne therefore becomes really practical for present day service.

A superheterodyne receiver for police 8-meter work should also tune broadly, since even with MOPA or crystal control in the car sets, the main station must have a standby service without constant retuning. The ordinary first oscillator in the superheterodyne will drift from 20 to 80 KC as its temperature changes and with variations of line voltage. This means that the IF amplifier should be broad enough in its tuning to take care of this oscillator drift. The car transmitters are also liable to drift; therefore the IF amplifier should be broad.

Most 5-meter superhets have lots of noise and very little signal. The trouble usually lies in too much IF gain and not enough RF gain ahead of the mixer tube. A straight RF amplifier will provide some gain, but regeneration is the real answer. Regeneration at the IF frequency does no good, but it can be used in either the RF stage or in the detector grid circuit. Both methods were tried and best results were obtained by using regeneration in the detector circuit, since antenna resonance has no effect of dead spots in the regeneration control. Better weak signal response from a signal generator was obtained by using first detector cathode tap regeneration than when the same method was used for the RF tube.

The image interference is minimized because of regeneration and two pre-selection tuned circuits. The IF frequency being about 2.7 megacycles, the image is 5.4 MC away from the desired signal. This means no image interference from other amateur signals in the 5-meter band of from 56 to 60 MC.

AVC was included in this set to prevent overload on strong local signals. To pro-

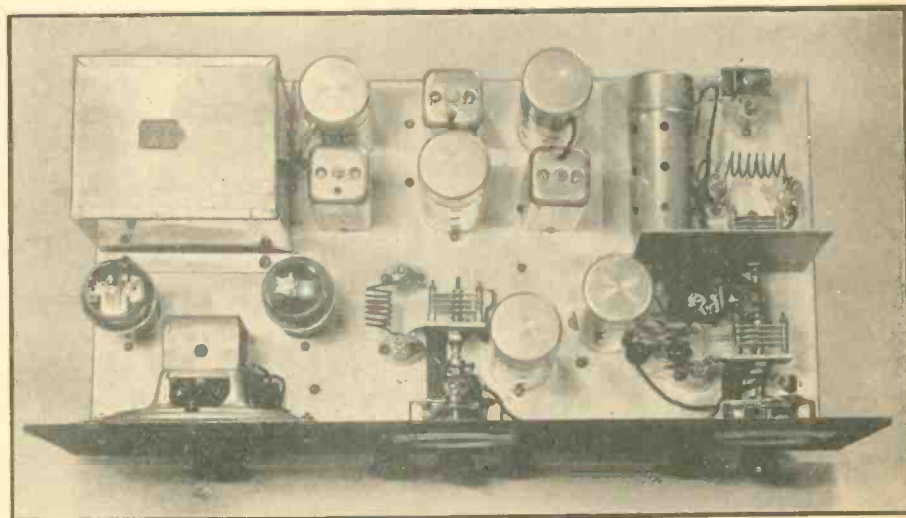

• Looking down into the 5-meter Super. The RF coil is mounted horizontally to permit the use of very short leads. An aluminum shield isolates the RF stage from the detector. The inductances are mounted on porcelain stand-off insulators. The power transformer is at the left rear of the chassis. It is the new UTC Niklshield unit, with 6.3 volt filament winding. The midget dynamic speaker is a 5-inch Magnavox.

this trouble. The antenna coupling condenser should then be connected across the tuning condenser and a Faraday electrostatic shield placed between the tuned grid coil and tuned antenna feeder coil. Most of the auto QRM is picked up in the down leads and is transferred beautifully by even the slightest bit of capacity coupling. The receiver should be mounted in a relay rack with a metal dust cover, or in a metal cabinet if used on a table or desk. Too much emphasis cannot be placed on the need of using an efficient, noise-reducing type of receiving antenna.

Several oscillator circuits were tried and best results were had from a 76 tube instead of the usual electron coupled 6C6 or screen grid tubes. A form of electron coupling is used to the mixer tube because the suppressor grid is used for that purpose. This puts the suppressor grid at a positive potential of about 100 or so, since it ties directly to the oscillator plate. However, this seems to give better conversion gain in a regenerative detector than any other system tried. Invariably, comparisons between capacity coupling or any other form and this method, gave the latter the edge by about two or three times in sensitivity.

The receiver is mounted on a 7 x 19 x 3/8-inch aluminum panel for relay rack mounting. The holes for the loudspeaker opening and the two airplane type dials can be cut by means of a flying bar cutter. The chassis was made of No. 14 gauge aluminum because it is easily drilled and does not require plating. The chassis measures 9 x 17 1/2 x 1 3/4 inches. The pictures of the set give a good idea of the general layout of the parts. The signal comes in at the grid of the horizontally-mounted RF tube, through the first detector, two IF stages, second detector and power audio stage. The power equipment and loudspeaker are mounted at one end and the RF portion at the other. The IF amplifier occupies the rear middle portion and the high frequency oscillator the front middle portion. The oscillator tuning condenser must have an insulating coupling to the dial because this circuit is "hot" at both ends of the LC circuit.

The two radio frequency chokes were made by winding about an inch of winding length of No. 34 DSC on a 3/8-inch diameter bakelite rod. All of the coils were made of No. 14 wire, space wound on a half-inch diameter. These coils are mounted on small stand-off insulators near the tuning condenser terminals and they can be changed

in a few minutes, if the receiver is to be used on some other short wave band.

The RF tube was mounted horizontally so as to obtain a short plate lead to the detector grid circuit. All of the RF stage bypass leads are very short and return to the common ground point on the RF partition shield. By making this point at the tuning condenser rotor connection, interlock between the RF and detector circuits is avoided. Short leads are necessary in 5-meter work because an extra inch of wire adds quite an appreciable value of inductance.

The IF amplifier uses about 2.7 MC as its frequency. The transformers were home-made affairs, using the parts of regular IF

and were made by pulling off 40 feet of wire from each coil and closing up the coupling until adjacent coils were 1/4-inch apart. The IF frequency was adjusted to 1550 KC, but the selectivity was a little too great and the image interference was troublesome. The higher frequency of 2700 KC or 2.7 MC proved to be best. So far no trouble has developed due to IF amplifier pick-up from the antenna circuit on 110 meters. This is minimized by the use of the RF preselector stags and shielding.

The IF amplifier should be lined-up by means of a modulated oscillator of the all-wave type. Starting from the second detector circuit, each stage should be aligned by

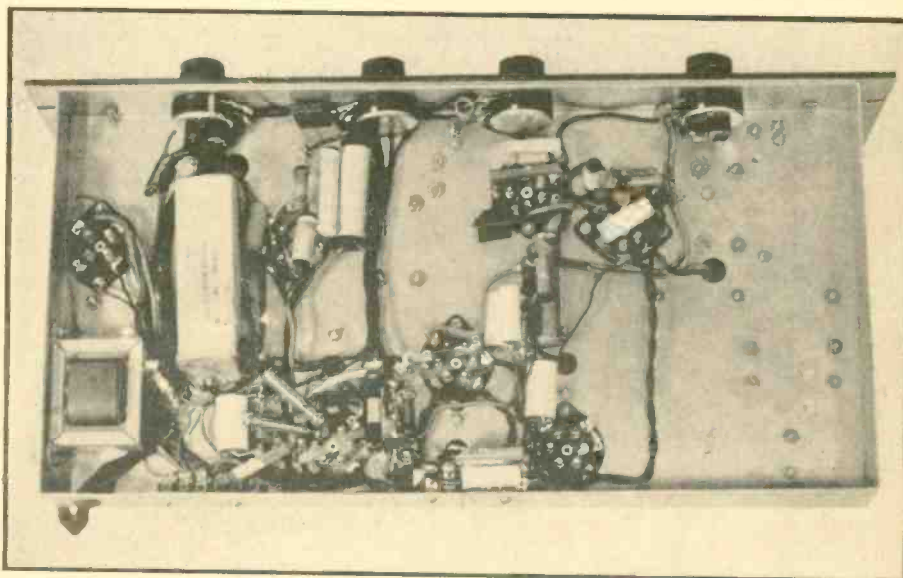

Under-chassis view, showing proper location for filter choke and condensers.

transformers. Those used in this set were wound on 3/8-inch diameter tubes. The 450 KC litz coils were removed and two windings each of 120 turns of No. 34 DSC wire put on in jumble fashion to cover a winding length of 3/8-inch. 1/8-inch spacing was used between adjacent coil edges. These windings, tuned with the mica trimmers of the original transformer, cover from approximately 100 to 120 meters. If one lives very close to a 120 meter police station it would be desirable to use about 100 turns and tune the transformers to about 90 or 100 meters. The first transformers tested used litz wire

coupling to the oscillator, then a recheck made of the overall amplifier by coupling the oscillator into the first detector grid circuit. The latter should connect temporarily through a 1000 ohm resistor to ground instead of to its LC circuit, while aligning this IF amplifier.

Alignment of the RF and detector stages is fairly simple. The detector coupling condenser should be adjusted until its capacity is low enough to allow the first detector to break into oscillation when the regeneration control is on full at both ends of the tuning range. The RF antenna coupling, or trimmer condenser, should be adjusted together with slight coil turn respacing until the noise level is highest throughout the band. There is usually enough noise from auto ignition to accomplish this, although a harmonic signal from a modulated all-wave oscillator is much superior for this purpose.

An interesting test was made with a signal generator and a small radiating antenna. A regular receiving antenna was first connected to a good super-regenerative receiver and the signal attenuated in the generator until it was just barely noticeable in the high background noise of this form of receiver. The super-regenerator was then replaced with the superheterodyne receiver and this same signal gave loudspeaker volume without the background noise of the other set. The absence of background hiss is especially pleasant when comparing the two sets for loudspeaker operation. When the auto ignition noise level is low, the 5-meter signals roll in and out without any fuss or change of hiss level, making it difficult to tell an R9 signal from an R6 signal. If the local flashing sign or auto ignition QRM is high, the 5-meter signal strength can be judged by the amount that it overrides the noise level.

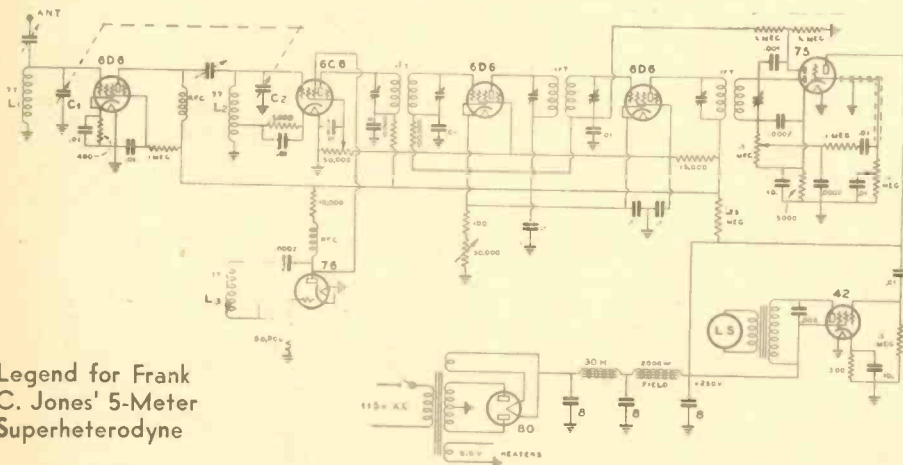

Legend for Frank C. Jones' 5-Meter Superheterodyne

- L1 and L2—Each 1 1/2 in. long, 7 turns, No. 14 enameled wire, 1/2 in. dia. turns. L3—1 in. long, 7 turns, No. 14 enameled wire, 1/2-in. dia.
- C1, C2, C3—100uufd. double-spaced variable condensers, with only 7 of the original plates remaining. Maximum capacity of these re-built condensers to be about 18uufd.
- I.F. Transformers tuned to approximately 2,000 KC.

What Goes On Inside a Vacuum Tube

By JAYENAY

• The common triode type of vacuum tube has three elements; a heated cathode, which is the source of the electrons, a control grid, which controls the flow of electrons from the cathodes and a plate, or anode, which receives the electrons which are thrown off the cathode.

It is difficult to directly visualize the action of a triode tube in an electrical circuit without the use of mathematics and equations, but in Fig. 1 an attempt is made to replace the triode vacuum tube with a mechanical analogy which uses electrical and mechanical principles less strange to the layman.

In Fig. 1 there are two separate circuits which have a common ground connection. One circuit terminates in the terminals A and B and includes the solenoid magnet. The other circuit terminates in the terminals X and Y and includes the fixed resistor R2, the variable resistor R1 and the high-voltage battery.

These two circuits are related mechanically through the iron pendulum which is also the movable arm of the variable resistor R1.

When a DC voltage is applied to the terminals A and B, current flows through the circuit energizing the solenoid magnet. The core of this magnet attracts the upper end (that above the fulcrum point) of the pendulum, which therefore swings in the direction indicated by the arrows. When the bottom of the pendulum moves to the right, it moves the point of contact between the pendulum and the resistance R1, thus reducing the total resistance in the right-hand circuit.

The more voltage applied to terminals AB, the more current will flow through the solenoid magnet, and thus the more the upper end of the iron pendulum will be attracted over to the left. Therefore, the more voltage applied to AB, the lower will be the resistance of R1.

As the lower end of the pendulum is swung up to the right, the more actual power it takes to move it, because the pendulum is becoming more and more horizontal and thus more of its weight is resisting further movement upward to the right.

What has all this to do with a vacuum tube? The solenoid acts as the control grid and R1 and R2 together equal the resistance of the plate-to-cathode electron path; in other words, the plate resistance. The high voltage battery corresponds to the B battery and the output transformer, which corresponds to the load, is connected across the terminals XY. Battery current (DC) flows through the right hand circuit.

As more voltage is applied to the solenoid, the lower the plate resistance (R1) becomes. This lowers the circuit resistance connected across the battery, and consequently more current flows. The more voltage applied to the solenoid, the higher the current goes in the battery, or plate circuit.

Now apply an AC voltage to the solenoid magnet instead of the DC used above. Choose, for the purposes of illustration, a low frequency, 10 cycles per second. Thus as the polarity of the voltage across the solenoid magnet changes, the magnet will alternately attract and repulse the upper end of the pendulum. This causes the resistance of R1 to alternately increase and decrease at 10 cycles per second. This means that the current in the battery, or plate circuit, also alternately increases and decreases at the rate of 10 cycles per second. What effect has this on the output transformer connected across XY? The primary of this transformer has

lines of magnetic force set up around it by the presence of the original electric current. When the current is varied by the change in the plate resistance R1, these lines of force change their direction and strength. Thus a varying magnetic field is set up around the primary of the transformer. We know that any coil whose turns are cut by a varying magnetic field has a voltage induced in it. It is not the field that induces the voltage, it is the CHANGE in field. Thus the changes in the magnetic field surrounding the primary of the transformer induce a voltage in the secondary winding, which is wound on the same iron core. Therefore the alternating change in DC current through the primary winding causes an induced AC current to flow through the secondary winding when the secondary circuit is closed by some form

output transformer is related to the amount of DC that flows through the primary circuit; the more DC that flows from the battery, the more will be the variation in that current which can be caused by the variation in R1.

In transmitting tubes it is found that there is a direct relationship between the minimum plate resistance of the tube and the amount of plate voltage that must be used to obtain a given RF power output, when the tube is used as a class C radio frequency amplifier. For example, the low plate resistance of the new 150-T allows a given amount of power output to be obtained at a materially lower plate voltage than if the type 852 were used, because the 150-T has a considerably lower minimum plate resistance under a given set of conditions.

Because this analogy of vacuum tube performance applies best to class C use of a vacuum tube, it is well to show how high plate efficiency is obtained. Note that there

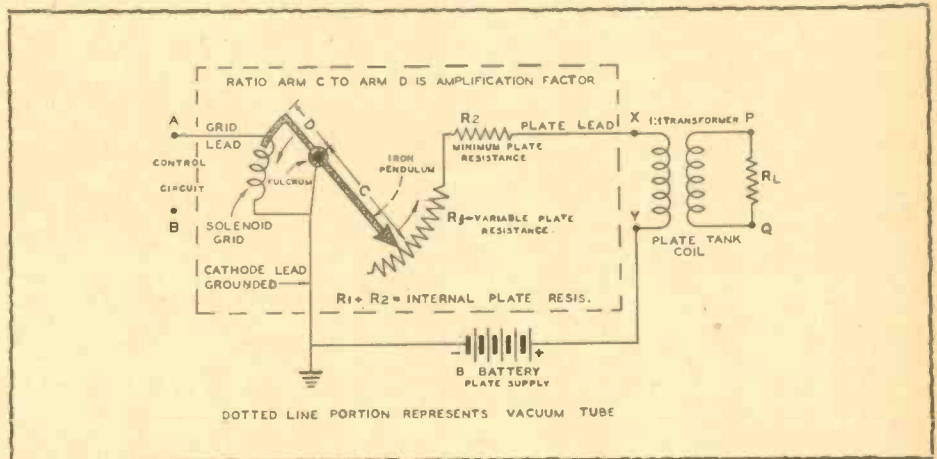

of load, such as the voice coil in a loudspeaker.

Briefly, then, a weak alternating voltage applied to the grid (solenoid magnet) circuit causes a large change in plate resistance (R1) which causes a large change in the DC plate current. This large change in DC current flows through the primary of the output transformer and induces a large AC voltage in the secondary of the output transformer. Thus the presence of a relatively small AC voltage in the grid (solenoid) circuit controlled the release of a much larger AC voltage in the output transformer.

Consider R2. To what does it correspond in the actual vacuum tube circuit? R2 represents the MINIMUM plate resistance.

This resistance is really a part of R1, but it represents that part of R1 which the pendulum cannot slide across and thus eliminate from the circuit. It is not a constant value of resistance but varies with both the grid excitation and the plate voltage. The higher the grid excitation, the lower this value of minimum resistance, because the higher the grid excitation, the further up R1 the pendulum swings. However, no amount of grid excitation can entirely eliminate the minimum resistance; thus it is shown as a separate resistor. This value of the minimum plate resistance is very important. It should be evident that the higher the value of this minimum resistance, the higher must be the battery voltage (B or plate supply voltage) in order to force the desired amount of current to flow through the plate circuit. The AC current that flows in the secondary of the

is a load resistance R_L across the secondary of the output transformer. Assume that the amplifier is handling radio frequencies, thus eliminating the iron core from the output transformer. The load resistance can be the resistance of an antenna connected to the secondary. Also assume that the impedance ratio of the output transformer is one-to-one. Thus the AC resistance reflected into the primary circuit is exactly equal to the resistance of the load. The total current that flows through the plate circuit must force its way through R1, R2 and the primary resistance of the output transformer, which in this case is the same as R_L . These resistances are all in series so that the voltage drop, across each resistance, will be proportional to its resistances. It also follows that the POWER dissipated in each resistor will be proportional to its percentage of the total circuit resistance. The power in R1 and R2 is dissipated in the form of radiant heat from the plate of the tube. The power used up by R_L is that power radiated usefully from the antenna. Thus we want to make R_L take as much power as possible and lose as little as possible in R1 and R2.

As the power divides in proportion to the voltages across R1-2 and R_L , it is desirable to make R_L as large as possible and R1-2 as small as possible so that most of the voltage drop will be across R_L . If R_L is nine times as high as R1-2, then the total power dissipated in the circuit will divide 9/10 in R_L and only 1/10 in R1-2. This means that 90 per cent of the power supplied by the bat-

(Continued on page 31)

Practical High Fidelity

By I. A. MITCHELL*

TO THOSE of us who have watched the progress of radio reception from its infancy, the forward movement of the past two years has been of considerable interest. Not only is the engineering fraternity beginning to talk in terms of high fidelity, but high fidelity is actually being sold to the public. The user of broadcast facilities is beginning to realize that in addition to fine studios and artists, program reproduction must have a low distortion level. In keeping with this, broadcast stations are continuously improving fidelity; lines are being equalized

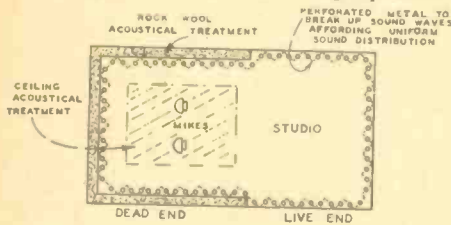

FIG. 1

and better audio equipment is being developed. Unfortunately, not all stations have been able to completely modernize their equipment. Using a real high fidelity radio receiver harmonic distortion and frequency discrimination become quickly apparent and as the dial is twirled to different frequencies, the high fidelity broadcast stations can readily be separated from those affording mediocre program fidelity.

Unfortunately, high fidelity as it has been applied to radio receivers during the past year has to an extent been too theoretical. From an engineering viewpoint, it is easy to picture a high fidelity mike placed in an ideal studio—working through a high fidelity transmitter at the broadcast end. It is also easy to picture a flat top tuner—a straight line amplifier—a high fidelity speaker combination at the receiving end. There is but one flaw in this entire picture, namely, acoustic operating conditions. While a microphone or speaker may have a perfect characteristic thirty feet off the ground in an ideal open air test, how will these units operate respectively in the studio or your home?

The importance of acoustics in the broad-

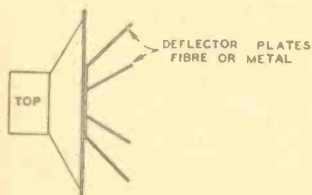

FIG. 2

cast station studio is well attested to by the fact that an entire new studio technique has been developed for high fidelity work. This system is called the "live and dead end" pickup, Fig. 1. From one-half to two-thirds of the studio, depending on its size, is lined with sound absorption material, while the balance of the room is finished off with hard surface walls and ceiling. The microphones are placed in the dead end where every note can be picked up from the program which goes on in the live end. The musicians, at the live end, can gauge their playing with a normal amount of reflection, using this type of studio, while the dead end microphone position eliminates abnormal reflection and standing waves.

Acoustics in the home should be studied

* Chief Engineer, United Transformer Corp.

just as carefully. When installed, a radio receiver should be placed at least a few inches from the wall or the low frequency response will be affected. It is also desirable to place the set in a number of different positions in the room and so determine where best acoustic conditions exist. Standing waves and objectionable reflections can often be eliminated in this way. The high frequencies reproduced by a high fidelity receiver are highly directional. If a deflector arrangement is not provided with the receiver, it should be added. Fig. 2 illustrates such an arrangement.

In many cases, particularly with modern small apartments, it is difficult to obtain a large baffle area. For true low frequency reproduction, a speaker baffle should be at least six to eight feet square. This is an impossibility in the average home, but equalization of the electrical low frequency end will help compensate for the loss of lows. Another alternative which is being brought to bear in the high fidelity receiver field is the acoustic labyrinth used to simulate a large baffle with a small space requirement. A unit of this type can readily be built by the amateur or experimenter. Put simply, the purpose of a baffle is to eliminate the pressure wave from the front of the speaker diaphragm reaching the rear of the diaphragm. In the acoustic labyrinth this is done on the same principle as a Maxim silencer. Referring to Fig. 3, it is seen that the long acoustic length of the labyrinth is placed between the front and back sides of the speaker diaphragm. To construct a unit of this type, get a wood box about 13 by 13 by 18 inches. The barriers shown consist of a 1-inch thickness of hair felt extending from the top to the bottom of the box supported by chicken-coop wire. A one-inch passage is left at the end of the barrier for the sound pressure wave. At the bottom of the rear of the box an opening 2 inches long is left as an exit for the air. If the unit is operating properly, with normal music coming out of the speaker, practically no sound will be heard at the exit opening of the box.

For ideal audio amplifier fidelity, it is essential that high fidelity transformers be used. Unfortunately, while these are excellent for the broadcast station, laboratory, or high quality sound system, they are too expensive for the average home. Fig. 4 illustrates an amplifier circuit using medium priced components which has excellent fidelity. The amplifier is simple in nature and

construction and provision for the tuner filament and plate voltage is provided. The use of two push-pull stages tends to reduce plate and filament hum and eliminates the necessity for parallel feeding the interstage transformer. A special input transformer feeds two 57s connected as triodes which are in turn transformer coupled to two 45s operated A prime self bias. In the circuit shown 10 watts can be obtained from the 45 tubes before 5 per cent distortion is reached. If additional gain is desired, an additional

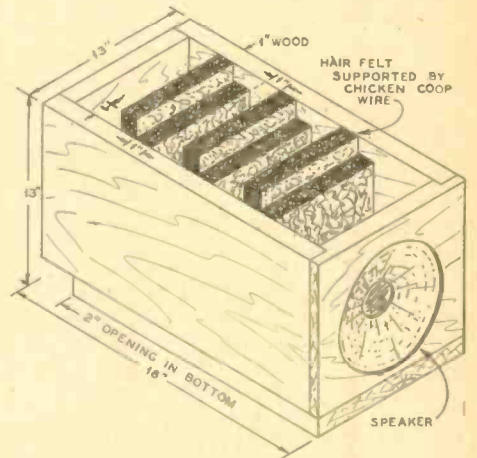

FIG. 3

stage of transformer coupled push-pull 57 triodes is suggested.

The circuit of Fig. 4 shows for the first time a newly developed input transformer having unusual characteristics. The primary of this transformer consists of two wind-

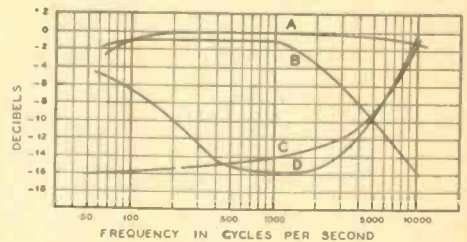

FIG. 5

ings, one is a high impedance winding designed to operate from the plate of an amplifier or detector tube. It is also suitable for use with a high impedance magnetic pickup. The other winding is a center-tapped low impedance winding suitable for
(Continued on page 27)

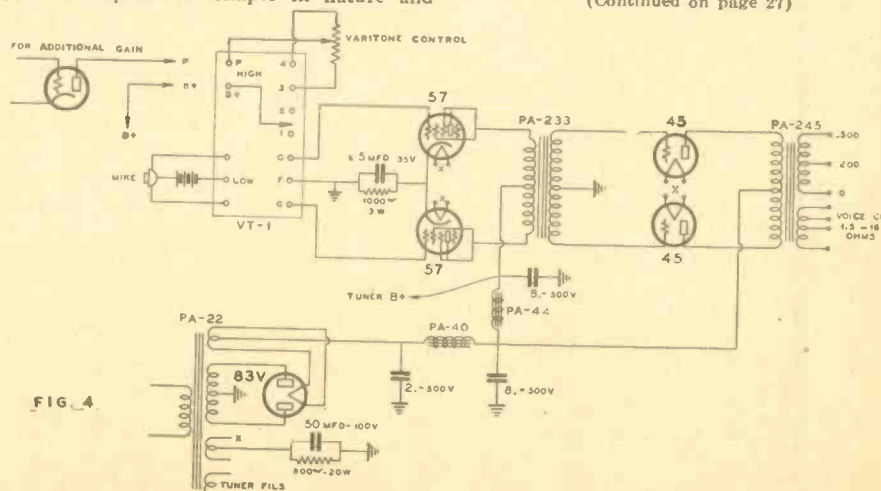

FIG. 4

New RCA-802 Amplifier Oscillator

● RCA-802 is a pentode transmitting tube of the heater-cathode type for use as an RF amplifier, frequency-multiplier, oscillator, and suppressor- or grid-modulated amplifier. The plate connection is brought out through a separate seal at the top of the bulb to maintain low grid-plate capacitance. Neutralization to prevent feedback and self-oscillation is generally unnecessary. The suppressor and the special internal shield of the 802 are connected to individual base pins.

TENTATIVE CHARACTERISTICS

Heater voltage (AC or DC)	6.3 Volts
Heater current	0.95 Amp.
Grid-plate capacitance (max.)	0.15 uuf
Screen-plate capacitance	0.5 uuf
Input capacitance	12 uuf
Output capacitance	8.5 uuf
Bulb	ST-16
Overall length	5 1/2"-5 3/4"
Maximum diameter	2 1/8"
Cap	small metal
Base	medium 7-pin bayonet

MAXIMUM RATINGS AND TYPICAL OPERATING CONDITIONS

As RF Power Amplifier—Class B (Telephony)*
(Carrier Conditions; for use with a Modulation Factor up to 1.0)

Screen voltage (Grid No. 2)	250 max. Volts
DC plate voltage	500 max. Volts
Suppressor voltage	40 max. Volts
DC plate current	30 max. MA
Plate dissipation	10 max. Watts
Screen dissipation	4 max. Watts

TYPICAL OPERATION:

DC plate voltage	400	500	Volts
Screen voltage (Grid No. 2)	150	200	Volts
Grid voltage, approx. (Grid No. 1)	-22	-28	Volts
Suppressor voltage (Grid No. 3)	0	0	Volts
Peak RF grid voltage	70	63	Volts
DC plate current	25	25	MA
DC screen current	6.5	7.0	MA
Driving power (approx.)	0.5	0.18	Watts
Peak power output (approx.)	11	14	Watts
Carrier power output (approx.)	2.75	3.5	Watts

* Grid No. 1 is control grid; grid No. 2 is screen; grid No. 3 tied to cathode; internal shield tied to cathode.

SUPPRESSOR MODULATION CHARACTERISTICS

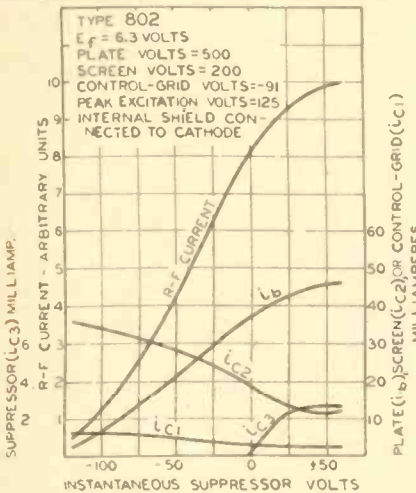

As RF Amplifier—Class C Telephony

(Suppressor Modulation)**
(Carrier Conditions; for use with a Modulation Factor up to 1.0)

DC plate voltage	500 max. Volts
Screen voltage	200 max. Volts
DC plate current	30 max. MA
DC grid current	7.5 max. MA
Plate dissipation	10 max. Watts
Screen dissipation	6 max. Watts

TYPICAL OPERATION:

DC plate voltage	400	500	500	Volts
Screen voltage	150	200	250	Volts
Grid voltage (approx.)	-85	-90	-90	Volts
Suppressor voltage (approx.)	-40	-53	-45	Volts
Peak AF suppressor voltage	40	53	65	Volts
Peak RF grid voltage	125	125	125	Volts
DC plate current	18	20	22	MA

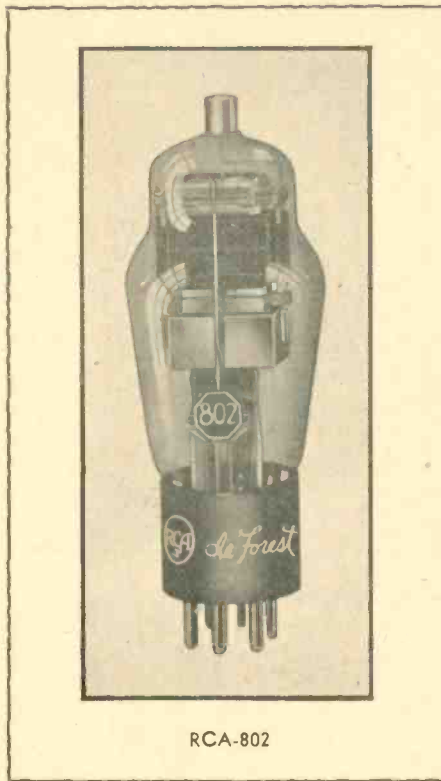

RCA-802

DC screen current	28	28	28	MA
DC grid current	7.5	5.0	4.5	MA
Driving power (approx.)	0.9	0.6	0.5	Watts
Peak power output (approx.)	8	12	14	Watts
Carrier power output (approx.)	2	3	3.5	Watts

** Grid No. 1 is control grid; grid No. 2 is screen; grid No. 3 is suppressor; internal shield tied to cathode.

As RF Amplifier—Class C Telephony
(Grid Modulation)†
(Carrier Conditions; for use with a Modulation Factor up to 1.0)

DC plate voltage	500 max. Volts
Screen voltage	250 max. Volts
Suppressor voltage	40 max. Volts
DC plate current	30 max. MA
Plate dissipation	10 max. Watts
Screen dissipation	4 max. Watts

TYPICAL OPERATION:

DC plate voltage	400	500	Volts
Screen voltage	150	200	Volts
Grid voltage (approx.)	-105	-130	Volts
Suppressor voltage	0	0	Volts
DC plate current	25	25	MA
DC screen current	7.5	8	MA
DC grid current	2	1	MA
Peak RF grid voltage	125	145	Volts
Peak AF grid voltage	40	50	Volts
Driving power (approx.)	1	0.8	Watts
Peak power output (approx.)	12	16	Watts
Carrier power output (approx.)	3	4	Watts

† Grid No. 1 is control grid; grid No. 2 is screen; grid No. 3 tied to cathode; internal shield tied to cathode.

As RF Amplifier—Class C Telegraphy‡
(Key-down Conditions)

DC plate voltage	500 max. Volts
Screen voltage	250 max. Volts
Suppressor voltage	40 max. Volts
DC plate current	60 max. MA
DC grid current	7.5 max. MA
Plate input	25 max. Watts
Plate dissipation	10 max. Watts
Screen dissipation	6 max. Watts

TYPICAL OPERATION:

DC plate voltage	400	500	500	Volts
Screen voltage	150	200	250	Volts
Grid voltage (approx.)	-85	-90	-100	Volts
Suppressor voltage	0	0	+40	Volts
DC plate current	45	45	45	MA
DC screen current	20	15	12	MA
DC grid current	5	2	2	MA
Peak RF grid voltage	130	125	135	Volts
Driving power (approx.)	0.6	0.25	0.25	Watts
Power output (approx.)	9	14	16	Watts

‡ Grid No. 1 is control grid; grid No. 2 is screen; grid No. 3 tied to cathode; shield tied to cathode.

Installation

● The base pins of the RCA-802 fit the seven-contact (0.855-inch pin-circle diameter) socket which may be installed to hold the tube in any position. The plate lead of the tube is brought out at the top of the bulb to a metal cap. A flexible lead should be used to make connection to the plate cap so that normal expansion will not place a strain on the glass at the base of the cap. Likewise, the cap should not be made to support coils, condensers, chokes, etc. Under no circumstances should anything be soldered to the cap, as the heat may crack the glass seal.

The bulb of this tube becomes very hot during continuous operation. For this reason it should not come in contact with any metallic body nor be subjected to drops or spray of any liquid. Free circulation of air should be provided.

The heater of the 802 is designed to operate at 6.3 volts. The heater supply may be either AC or DC. AC is usually employed because of its convenience. The voltage across the heater terminals should be checked periodically. In radio transmitters during "standby" periods, the heater should be maintained at its rated voltage for convenience in promptly resuming transmission.

The cathode of the RCA-802, when operated from an AC supply, should preferably be connected directly to the electrical midpoint of the heater circuit. When it is operated from a DC source, the cathode circuit is tied in either directly or through bias resistors to the negative heater supply lead. In circuits where the cathode is not directly connected to the heater, the potential difference between them should be kept as low

CONTROL-GRID MODULATION CHARACTERISTICS

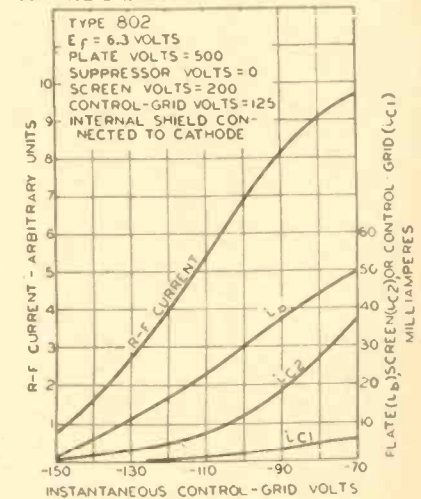

as possible. If the use of a large resistor is necessary between heater and cathode of the 802 in some circuit designs, it should be bypassed by a suitable filter network to avoid the possibility of hum.

The plate dissipation of the 802 (the difference between input and output) should never exceed the maximum value given under MAXIMUM RATINGS and TYPICAL OPERATING CONDITIONS. At these maximum values the plate shows no color when the power switches are opened with the tube operating in the dark.

A DC milliammeter should be used in the plate circuit to provide a ready check of the plate current. Under no condition should

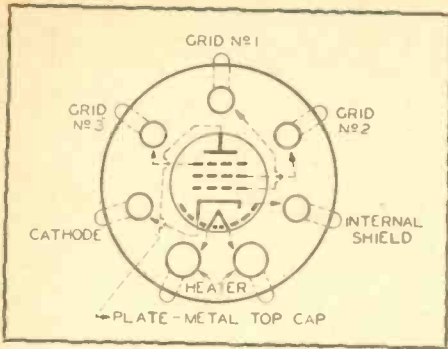

the DC plate current exceed the maximum values given under MAXIMUM RATINGS and TYPICAL OPERATING CONDITIONS.

Suppressor grid voltage for the RCA-802 may be obtained from any suitable DC supply. In cases where the suppressor draws current, the supply should be a battery or other DC source of good regulation.

The internal shield is brought out of the tube to its own separate base pin. The internal shield should be tied to a terminal operating at zero RF and/or AF potential. In most cases this connection will be made to the cathode or suppressor terminal.

Adequate shielding and isolation of the input circuit and the output circuit are necessary if optimum results are to be obtained. If an external shield is employed with the 802, it should be designed to enclose the base end of the tube and extend up to a point level with the bottom of the internal shield. Clearance between the glass bulb and external shield should be at least 1/16 inch. The impedance between the screen and filament must be kept as low as possible by the use of a by-pass condenser.

When a new circuit is tried or when adjustments are made, the plate voltage should be reduced in order to prevent damage to the tube or associated apparatus in case the circuit adjustments are incorrect. It is advisable to use a protective resistance of about 3000 ohms in series with the common negative high-voltage lead during such adjustments.

The rated plate voltage of this tube is high enough to be exceedingly dangerous to the user. Great care should be taken during the adjustment of circuits, especially those in which the plate tank coil and condenser are at the DC plate potential.

Application

As a Class B radio-frequency amplifier, RCA-802 may be used as shown under MAXIMUM RATINGS and TYPICAL OPERATING CONDITIONS. Grid No. 1 is the control grid; grid No. 2 is the screen; and grid No. 3 is tied to the cathode and serves as the suppressor. The shield is connected to cathode. In such service, the plate is supplied with unmodulated DC voltage and the grid is excited by RF voltage modulated at audio frequency in one of the preceding stages. The plate dissipation for this class of operation should not exceed 10 watts.

Grid bias for the 802 as a Class B RF amplifier should be obtained from a battery or other DC source of good regulation. It should not be obtained from a high-resistance supply such as a grid-leak, nor from a rectifier, unless the latter has exceptionally good voltage regulation.

As a grid-modulated Class C RF amplifier, RCA-802 may be used as shown under MAXIMUM RATINGS and TYPICAL OPERATING CONDITIONS. Grid No. 1 is the control grid; grid No. 2 is the screen; and grid No. 3 is the suppressor. The shield is connected to cathode. In such service the plate is supplied by unmodulated DC plate

voltage and the grid bias is modulated at audio frequency. Grid bias for this service should be obtained from a battery or other DC source of good regulation. It should not be obtained from a high-resistance supply.

As a suppressor-modulated Class C RF amplifier, RCA-802 may be used as shown under MAXIMUM RATINGS and TYPICAL OPERATING CONDITIONS. Grid No. 1 is the control grid; grid No. 2 is the screen; and grid No. 3 is the suppressor. The shield is connected to cathode. Grid bias for this service may be obtained in the same manner as for Class C RF telegraph service. Suppressor bias may be obtained from a battery, or a bleeder tap on the high voltage supply.

As a Class C RF amplifier for telegraph service, RCA-802 may be operated as shown under MAXIMUM RATINGS and TYPICAL OPERATING CONDITIONS. Grid No. 1 is the control grid; grid No. 2 is the screen; and grid No. 3 is the suppressor. The shield is connected to suppressor.

Grid bias for Class C telegraph service may be obtained from: a grid leak of 20,000 to 50,000 ohms, depending upon amount of grid excitation; from a battery; from a rec-

may be obtained with widely different values.

The DC grid current will vary with individual tubes. Under any condition of operation the maximum values should not exceed 7.5 milliamperes.

If more power output is required than can be obtained from a single 802, two or more of these tubes may be used either in parallel or in push-pull. The parallel connection provides approximately twice the power output of a single tube without an increase in exciting voltage, while the push-pull connection gives twice the output but requires twice the RF excitation voltage necessary to drive a single tube; with either connection, the grid bias is the same as for a single tube. The push-pull arrangement has the advantage of balancing out the even-order harmonics.

When two or more RCA-802s are operated in parallel, a non-inductive resistance of 10 to 100 ohms should be placed in series with the grid lead of each tube, close to the socket terminal, to prevent parasitic oscillations.

As a pentode oscillator (crystal or self-excited), the 802 should have its screen, suppressor, and shield connected the same

TRANSMITTING CIRCUIT DIAGRAM SHOWING USES OF TYPE 802 R-F POWER PENTODE

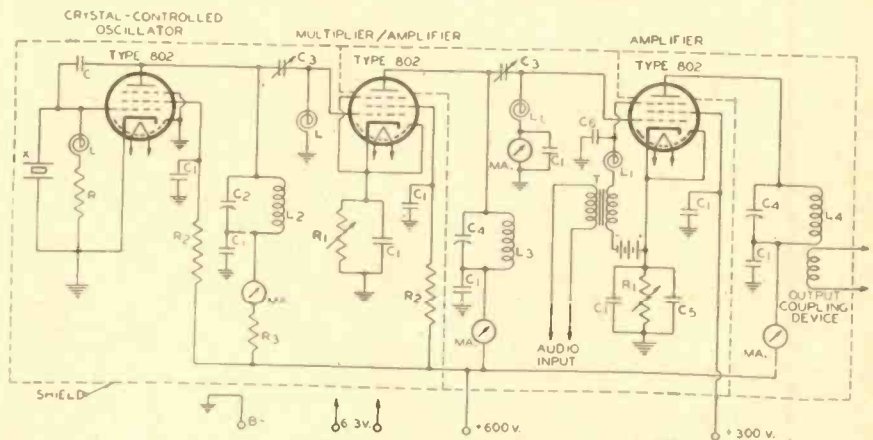

C = 3 uuf (Approx.) for Feedback
 C₁ = .01 uf
 C₂ = 10.0 uuf (Max.)
 C₃ = 30 uuf (Max.)
 C₄ = 50 uuf (Max.)
 C₅ = 10 uuf (low voltage)
 C₆ = .0001 uf

L₁, L₂ = RF Chokes
 L₂, L₃, L₄ = Value dependent on frequency
 R = 40000 Ohms, 2 watts
 R₁ = 2000 Ohms (Max.) 10 watts
 R₂ = 20000 Ohms, 10 watts
 R₃ = 4000 Ohms, 10 watts
 T = Modulation Transformer
 X = Crystal

Note—Ground Connections Made to Shield.

tifier; or from a cathode-bias resistor (preferably variable) by-passed with a suitable condenser. The cathode-bias method is especially desirable due to the fact that the grid bias is automatically regulated and that there is little chance of the plate current becoming dangerously high either with or without RF grid excitation. When the grid-leak method of obtaining grid bias is used, bias is on the tube only when RF excitation is applied. Since grid-bias values are not particularly critical, correct circuit adjustment

as in amplifier service. Because the general internal shielding is unusually effective, it is generally necessary, in this service, to introduce external feedback. This may be done by the use of a small condenser of 2 to 3 uuf connected between grid and plate.

RCA-802 is not recommended for use as a Class A triode amplifier, Class B AF triode amplifier, or Class C plate-modulated tetrode amplifier, because it is inadvisable to operate this tube with any of the grids at the maximum rated plate voltage.

UNSOLVED

"A problem well stated is half solved"
 —Steinmetz.

• In this column will be briefly outlined some of the problems of general interest in the radio field which remain unsolved. You are invited to submit your statements regarding unsolved radio problems. A one-year subscription to "RADIO" will be given each month to the person who sends in the best worded statement of a timely problem.

WANTED—A new high voltage variable condenser. Should be compact, insulated for at least 15,000 volts, and free from losses.

A small condenser about the size of the midgets used in receivers, sealed inside of an evacuated glass tube, may represent the answer to this problem. Its capacity can be varied by attaching a heavy weight to the rotor in such a manner that the rotor remains fixed, while the stator is moved in relation to the rotor, by rotating the glass envelope. Connections to the rotor and stator can be brought out of the envelope through tungsten seals, as in vacuum tube manufacture. One-eighth-inch plate spacing in a good vacuum will easily withstand 20,000 volts.

very little capacity coupling exists between the antenna and first detector coil. This 1-inch bakelite tube is controlled from the front panel by means of a plunger action

40 Meters	80°	95°	50° to 60°
75 Meter Phone Band	45°	50°	25°
80 Meter C.W. Band	50°	95°	100°

The "222 Communications Receiver"

An Efficient, Simple and Inexpensive Superheterodyne

Mercury Vapor Rectifier Tubes

By RICHARD H. SEAMAN*

● The average life of a mercury vapor rectifier tube is approximately 1,000 hours. It is possible that 10,000-hour mercury vapor rectifiers will soon be manufactured.

The failure of a mercury vapor rectifier tube before 5,000 hours, if properly used, is generally due to one of the following reasons:

1. **Improper Tube Design:**
 - a. Poor heat dissipation
 - b. Low voltage breakdown
 - c. Inadequate filament design
2. **Improper Exhaustion:**
 - a. Poor vacuum
 - b. Impure mercury
 - c. Contaminated elements
3. **Inferior Materials:**
 - a. Oxide coating
 - b. Filament base metal
 - c. Plate
 - d. Glass envelope
4. **Flaking-off of Oxide Coating:**
 - a. too-wide ribbon
 - b. Low wattage filament
 - c. Oxide not thoroughly decomposed

If the above considerations are all taken care of, the life of the tube will be proportional to the amount of oxide coating on the filament.

The first problem is to apply a maximum amount of coating and to provide a means to keep it there. The customary coating process consists of spraying or dipping the filament ribbon in barium and strontium carbonates with pyroxylin binders. This is a very unsatisfactory process for large filaments because the amount of coating which can be uniformly put on and not flake off is limited by the surface tension of the coating. The use of wire mesh instead of ribbon for filament base allows the use of oxide coating without pyroxylin binder and there is no flaking whatsoever. The coating surrounds the individual wires and fills the intervening space. The maximum amount of coating that can be applied with good results is limited by the heat radiating ability of the oxide coating. The heat dissipation of the coating increases with the thickness of the coating and the filament will therefore run cooler, unless it is shortened. If the coating is too thick, the outside surface will run cooler than that next to the filament; the filament runs too hot, thus causing increased electrolysis of the oxides and evaporation of the filament base metal. With the proper or possible maximum coating applied, the life of the tube will be roughly dependent on the ratio between mean plate current and filament wattage. The more generous the filament wattage, the longer the tube life. (The filament should have over 12 watts per ampere mean DC plate current). The filament voltage should not be over two-and-one-half volts; a higher-voltage filament will tend to emit only from one end of the filament, resulting in a rapid deterioration of oxide and short life. Five-volt tubes should be of the heater type.

The next equally important item for a long life rectifier is an extremely high vacuum, equaling that of large transmitting tubes. A high degree of exhaust must be obtained before any mercury is introduced into the tube. This is necessary because it is impossible to degasify the elements and obtain a high degree of vacuum with any mercury present in the tube. High vacuum is the only insurance against high voltage breakdown, and the spacing of the plate and filament apparently have no effect. It is possible to get a higher degree of vacuum, with the proper pumping equipment, without the use of a

"getter". This is very essential because mercury, under these conditions, will adhere to the glass walls and will seriously affect the mercury vapor pressure of the tube. The operating pressure of mercury vapor is a critical factor for long life and high voltage breakdown. The pressure increases with the increase in temperature. If the tube is so designed that no mercury remains adherent to the glass walls and collects only in the coolest part of the tube, the pressure will then be correspondingly lower. As there is no appreciable consumption of mercury during the operation of the tube, the minutest drop of mercury is sufficient. The normal DC drop is from six to fifteen volts and decreases with the rise in temperature. The curve in Fig. 1 shows the relation between pressure and the increase in temperature.

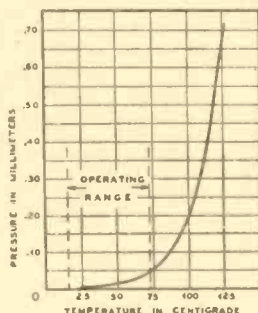

FIG. 1

The decrease in DC voltage drop with the increase in temperature is shown by Fig. 2. Fig. 3 is plotted to show the decrease in inverse peak voltage as the temperature increases. The DC voltage drop will increase with age and deterioration of the oxide coat-

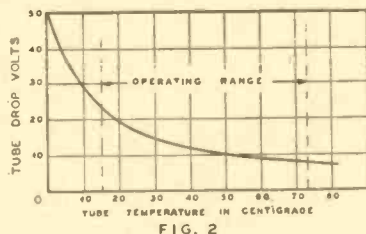

FIG. 2

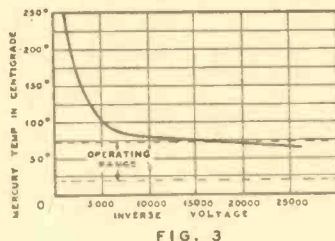

FIG. 3

ing. When the tube is in operation and working properly, the discharge is either a purple or dark pure-blue color. If the filament fails to give sufficient emission or is overloaded, the discharge is sea green.

Because the rectifier is frequently subjected to sudden heavy loads the tube must withstand sudden changes in temperature and this is one of the reasons why the soft glass tubes fail. Sudden changes in temperature will cause the glass to crack or soften and "pull in". Nonex, a hard glass, has a lower coefficient of expansion than soft glass, 3×10^{-6} for Nonex, compared with 18×10^{-6} for soft glass, and has considerably higher heat resistance. Nonex is the ideal glass for any

type of transmitting tube. The operating temperature range of a mercury vapor is critical. Care should be taken when building the power supply so as to give the rectifying tube generous or forced ventilation. The tubes should be well spaced from magnetic

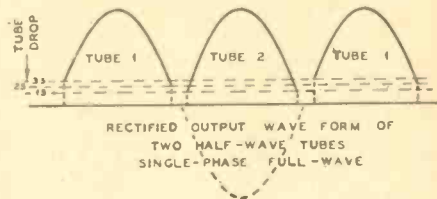

FIG. 4

or radio frequency fields. These fields tend to produce breakdown effects and they are detrimental to tube life and performance. The presence of such currents may sometimes be detected by a glow in the tube with no applied plate voltage. The absence of this glow does not necessarily mean freedom from these harmful currents because they may only occur at the time the tubes are conducting. The rectifier plate leads should be provided with radio frequency chokes and the tubes should be shielded with copper screen. The filament should be kept at rated voltage under operating conditions. Less than the recommended voltage may cause heavy filament bombardment and loss of emission. Greater than rated voltage will cause evaporation of the filament and will shorten the life of the filament.

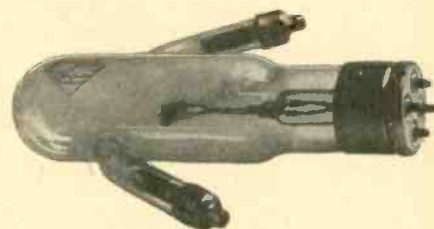

FIG. 5

The fundamental limitations in the operation of a rectifier are the maximum peak plate current and the maximum peak volt-

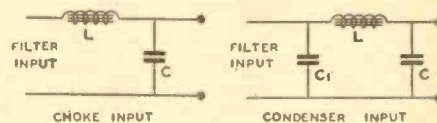

FIG. 6

FIG. 7

age. Maximum peak plate current is the highest peak current that a rectifier tube can safely handle. If a large choke is used in the filter circuit next to the rectifier (Fig. 6, choke input) the peak plate current is not much greater than the load current. If a large condenser is used in the filter next to the rectifier (Fig. 7, condenser input) the peak current may be, and often is as much as four times the load current. Peak current can best be measured with an oscillograph. It is not advisable to use condenser input in a single phase full-wave rectifier system merely to get higher voltages because this method only raises the voltage about 10% and lowers the load current considerably. For instance, with the '66 type rectifier a 1 mfd. condenser, in a condenser input filter, will lower the safe maximum load current to about 150 mills. The remainder of the rated current is used in circulating current and is of no use whatsoever. For best results use

(Continued on page 29)

* Chief Engineer, Radio Scientific Laboratory.

How Telegraphers Are Made

First of a Series By T. R. McELROY, World's Fastest Telegrapher

PART I

SEATED before a "mill" with a set of phones clamped on my nerve-tingling ears, watching the judges and awaiting the whiz of a Wheatstone with code batting out around 50 or 60 words per minute—hey, it's a cinch—compared with sitting in front of this typewriter right now trying to find words with which to start some kind of an article that will be worth the time of "RADIO" readers wading through. So here goes! Stay with me, ops. I'm no Shakespeare nor Wilde, nor Poe. And no matter how greatly I may admire some of the personal proclivities of those writing gents (?), I couldn't even attempt to emulate their facile pens with my rusted typewriter. But I will try to tell you, truthfully, something about code working. And I pledge you my word that if you'll sweat half as much in reading it as I do in writing it, you'll start yourself on the road toward better operating. Let's go!

Back in '14 following my "graduation" from school (they threw me out for the good of the school), I proceeded with the usual matriculatories attendant full fledged membership in the fraternity of "all day trotters" in the University of Western Union. Those were the happy days when you'd deliver a message to a non-English speaking addressee and painstakingly explain that there was a small charge of one dime! We used to pool the dimes and buy cans of beer. I remember we had an empty pickle tin that held about a gallon. It was really a vitally necessary adjunct to the providing of good service. Tramping through hot, dusty streets was thirst provoking—and when you recall the large numbers of horses in those days you'll readily realize that a messenger boy's throat required the thorough cleaning attendant the sluicing down of gulps of beer.

A few months on the streets taught me the necessity for "higher education", and the greatest heights to which any messenger might ever aspire—was the third floor, where the Morse operators sat in the midst of a clatter greater than any steel mill produces. I can remember as though it were only yesterday, sneaking up the backstairs to watch those fellows sitting there with their legs crossed and "putting ten on a line" with the greatest of ease. This guy that we're singing about these days who plays around with a flying trapeze—why he is a hard worker compared with those old time telegraphers who turned out 50 and 60 messages an hour with Murad-like nonchalance. I can remember one guy, Bucky Kane. He used to work Pittsburgh. And to this day I can see him sitting there copying, chewing tobacco with the priceless sense of security that was his in the knowledge of his own personal spittoon—a paper cup in his shirt pocket!

I started doing little odd jobs. Running errands to deliver personal notes for the operators. Boston was a wicked city in those days. And we had what the evangelists might term "sinks of iniquity".

So, anyhow, in return for my efforts, some of the Morse men would give me a little practice on their "shorts"—their 15-minute respites from the grind. And out of a few weeks of this smoking room tuition I emerged what I fondly figured to be a good operator. Well, sir, the first few minutes on a wire when they finally decided to try me out, convinced me that maybe there was another operator or two who might be better. You've

all been through it probably. That, anyhow, was my start as an operator.

I went through the various stages of working in the woods, moving up to the ways, and finally to the trunks where a man would work bonus, and have a chance to make a real week's pay, with the aid of a peculiar telegrapher's style of mathematics which skipped ten numbers occasionally. Be that as it may, however, I went through the grades and finally wound up as an operator at Camp Devens where I fought the battle



T. R. McElroy, Holder of World's Record for Fast Telegraphing.

for the outlawing of war—with a telegraph key. All I need now is another good war to sell some of my own telegraph keys! About 1918 or 1919 things were pretty dead at Devens, so I was let out. Coming back to Boston I found no telegraph jobs and thus commences the entry into radio work.

A few weeks loafing in Boston convinced me that eating was a habit so firmly entrenched in my system that I couldn't get over it. A kind of a senseless habit, but there it was and I had to make the best of it. So I managed to borrow a few bucks from some of the Morse men I had worked with, and, on the basis of a rumor that the RCA were hiring Continental code operators at their trans-oceanic station in Chatham, WSO,

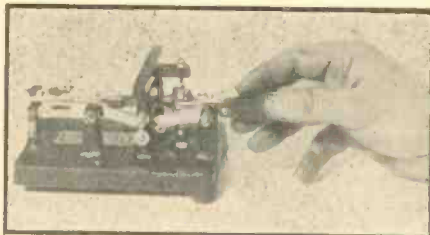

The "Bug" that McElroy used when he won the Championship.

I hopped a train for the Cape. Kripes! One way fare and I hardly knew Continental code.

Fortunately for me, and rather unusual, too, there was an American assistant superintendent who hired the operators. A real gentleman for whom it was a pleasure to work, Fred Heiser. It developed that Fred had been a real high grade Morse operator and during my test which brought out a palpable lack of knowledge of radio code, he threw some Morse at me. It was a cinch. A guy would have to be deaf, dumb and blind not to be able to copy the kind of Morse he sent.

So on the strength of that he hired me. So began the career of Mac as a radio operator. They were sorry! They could pay me only \$140 a month! Whoops! A first class Morse man was drawing only about \$125 in Boston at the time.

We used to work POZ, Nauen, Germany, and LCM, Stavanger, Norway. Sometime I'd like to tell you all of some of the experiences on those circuits. We had two and sometimes three landlines to New York, and it was on these circuits that I worked most of the time. Continental code. It was murder for about two weeks but then easy. They had some wonderful operators down in New York, too. All Morse men who had learned Continental as I did in a few days. There was Jack Dorien, and Jim Shea, and a fellow named Henderson, and a flock of other wonderful operators. And I remember especially Joe Chaplin who was probably as fine an operator as there ever was in the business. And Benny Suter and others. I wonder where they are now?

We had some great operators at WSO, too. I remember Joe Lynch who used to send with a straight key almost with Wheatstone perfection. Funny about Joe, too. He was about the only operator I'd ever met who was a real good operator and yet hadn't been a Morse man. I guess it ought to prove that an operator can be a first class man without first being a Morse operator.

I guess it was about 1920 when RCA decided to work the trans-oceanic stuff from New York and a lot of we operators were taken from Chatham down to the big city. That was the beginning of the end. You see I lived in Boston most of my life among American people. And I fondly congratulated myself upon my six or seven generations of Bostonese antecedency. And naturally I liked to talk about it. It didn't enhance my standing with the boys "from home" who ruled RCA. And they ruled it with an iron hand. So that between my propensity for voicing the virtues of our American citizenry, and my espousal of the cause of "collective bargaining", it was only a matter of time before I was out "for the good of the service"—they couldn't take it!

I remember I used to work POZ much the same as I'd work a Morse bonus wire, turning out faultlessly beautiful copy at extremely high speeds. But what did exceptional telegraphic merit amount to when the finer sensibilities of His Majesties' expatriates were offended by uncouth Americanisms! So sometime during 1920 I found myself back in Boston. Still a good American though somewhat befogged as to the consequences thereof. It cost me a job.

I "boomed" around the country, working here as a broker operator, there as a press operator, and again somewhere else with a packing house, and finally wearied of the road and its belly-reducing vicissitudinousnesses, (what a word to ripple out of a guy's fingers). So I returned to the bosom of good old Uncle Wess at Boston where my original boss and the kindly father to all Boston operators, took me again under his supervision. I'll never forget the debt I owe him: J. B. Rex, the chief operator of the Western Union in Boston.

Sometime late in 1921 or early 1922 there was a radio exposition at Boston wherein were displayed the latest models in salt box wound induction coils and basket wound vario-couplers, to say nothing of those new

(Continued on page 28)

New 5-Meter Developments

Jacobs' Duplex Transmitter-Receiver

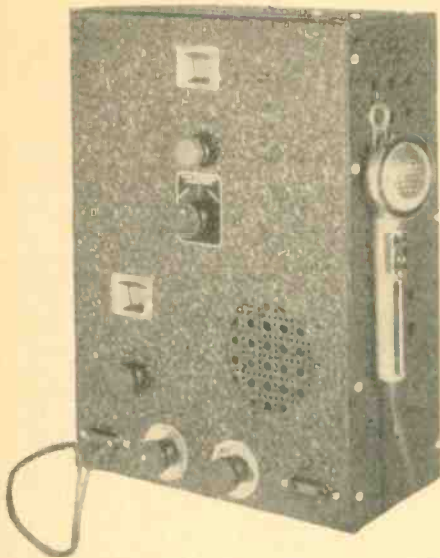

Exterior View of Radio Transceiver Laboratories Duplex Transmitter Receiver

THE Radio Transceiver Laboratories Type 53-6A6 Duplex Unit employs a radio-telephone transmitter similar to that of the Jacobs' 53-6A6 Transceiver. Like the transceiver, it employs twin-triodes, unity coupling and class B modulation; but in addition, the TR unit has a separate four-tube super-regenerative receiver and a dynamic speaker. Receiver radiation interference is eliminated and duplex operation is thus made possible. Duplex, or break-in operation is two-way transmission and reception, similar to that of a land telephone circuit. The operator talks and listens without throwing a switch. He can interrupt the conversation at will, or "break-in". A panel switch knob is provided for turning off the transmitter when listening on the transmitting frequency.

Transmitter and receiver are separate units, completely shielded from each other, and each has its own power supply socket. The unit can be installed with individual power supplies for transmitter and receiver, or both may be connected to the same power source. Supply cables should be shielded to prevent

receiver radiation. The entire duplex unit is housed in a black crackle finished steel case, 10x14x5-in. and is provided with ventilating holes and two handles. The latter may be used for securing a strap for carrying or for fastenings in mobile use.

The receiver employs a super-regenerative detector of the indirectly heated cathode type. No better type of receiver has been developed for ultra-high frequencies to date. The enormous sensitivity of this type of receiver creates a loud background noise when no signals are received, but this noise is completely eliminated when a strong station carrier is tuned in. A superheterodyne of equal sensitivity would have as great a noise level and an automatic volume control would then be necessary. The super-regenerative receiver has a perfect automatic volume control inherent with the detecting action.

Radiation from the detector and its attendant interference to other receivers is eliminated by the use of a screen grid RF stage

and careful shielding. The receiving antenna and receiver proper are shielded from detector radiation. If complete shielding is required, supply leads must also be shielded.

The super-regenerative detector is followed by a stage of AF amplification. A volume control is introduced in this circuit, as are tip jacks for headphone insertion. The final or output stage employs a power pentode capable of delivering 3.5 watts to the five-inch dynamic speaker which is mounted behind the front panel grill.

POWER REQUIREMENTS:

250 v.—175 MA (maximum)
2.5 v.—10.75 amps.

or

250 v.—175 MA.
6.3 v.—3.95 amps. (maximum)

Dynamotors running from a six-volt storage battery and delivering 250 v.—175 MA may be used with the TR-53-6A6 for mobile operation.

26 OR 56 MC AMATEUR BAND - OR 37 MC EXPERIMENTAL BAND
TYPE TR 53-6A6 DUPLEX TRANSMITTER-RECEIVER
2.5V OR 6.3V FIL

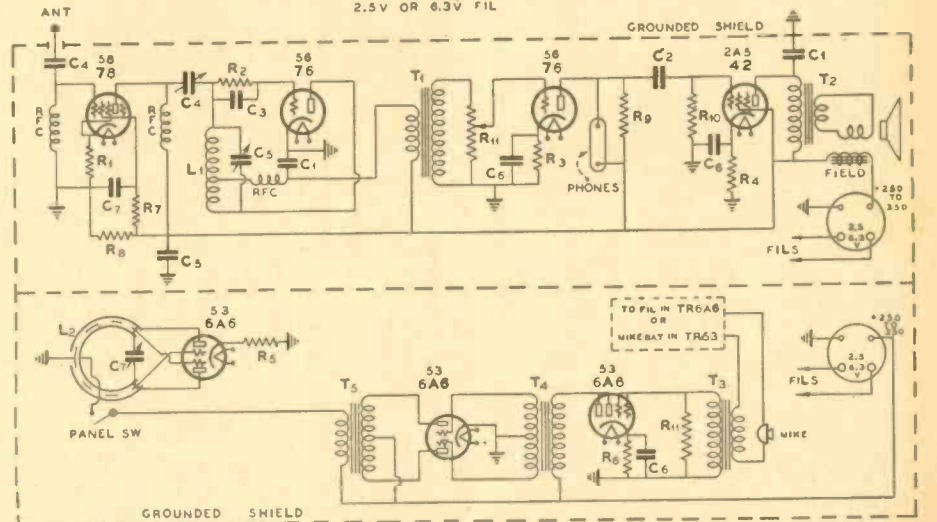

R1—400 ohms. R2— $\frac{1}{2}$ megohm. R3—2700 ohms. R4—500 ohms, 2 watt. R5—500 ohms, 2 watt. R6—1000 ohms. R7—50,000 ohms. R8—40,000 ohms. R9—100,000 ohms. R10—250,000 ohms. R11—500,000 ohms. RFC—50 turns No. 30 DSC on $\frac{1}{8}$ -in. dowel. C1—.004 ufd. C2—.05 ufd. C3—.00025 ufd. C4—35 ufd. C5—1 ufd, 450 v. C6—5 ufd, 25 v. C7—15 ufd Cardwell. L1—9 turns No. 12, $\frac{1}{8}$ -in. dia. (60 MC) spaced thickness of wire and tapped at 6 turns. L2—2 turns, $\frac{1}{8}$ -in. copper tubing, 2-in. dia., with piece of No. 19 Corlac 1800 v. insulated solid wire threaded through for Grid Coil (60MC). T1—3:1 Audio Trans. T2—Pentode Output Trans. T3—Mfc. Trans. T4—Class B Input, UTC HB1 or NS29. T5—Class B Output, UTC HBM or NS33.

A Deaf Mute Asks For An Amateur License—(Continued from page 6)

and also to the federal communication commission to help you get an amateur radio station license.

Station W8LDH of South Haven, Mich., wrote to Adolph to say: "... Have showed your letter to various local hams and they all think you should have a license and will do anything in their power to help you as I will also ..."

The stack of mail of this nature is legion. All over the country radio hams are writing to Washington to aid the man who refused to be stumped by a disability that would have been insurmountable to many. From coast to coast the night hawks of the air are waiting for the first spoken word of the man who has never spoken and who hopes soon through government generosity to talk direct to his many friends in the crystal whispers of DX. (Adolph Czajka's QSL card is reproduced here.—Ed.)

FROM ONE SPECIALIST TO ANOTHER

I am the first deaf mute radio fan

I watched ur sigs on my signal recorder white paper tape
at M., C. S. T. Hrd on 19

Home Made
100% Signal Recorder Tape
Tape-puller Power Amplifier
A pair of 45's Push-Pull
National's Parts, monitors or
frequency meter

Believe It or Not
U C H I'm deaf mute fan as ham
I hv no head-phone or loud-sprk.
Vy 73 es DX. OM.
Adolph J. Czajka, Opr.
(Deaf mute fan es ham)

If you want to read the white paper tape of your sigs
Write me on ur QSL crd OM. I wl send it to u.
Wud appreciate ur crd OM

- AMATEUR NEWS -

Largest Amateur Gathering To Be Staged in San Francisco

A TWO-DAY amateur conclave and high-frequency radio show will be staged by the Federation of Radio Clubs of Northern California, a newly-formed association which comprises the more important radio clubs. The purpose of the Federation is to promote better conventions and hamfests and to enable the radio clubs of the entire northern portion of the state to more effectively work together.

New innovations in hamfests are promised when the amateurs of Northern California convene on February 23rd. The affair will close on February 24th. There will be a series of contests to determine the best de-



"The Prize Drawing"
—or "After the Raffle Was Over"

signed and constructed pieces of radio equipment; there will be contests for fixed and mobile 5-meter equipment, receiver and transmitter contests. All amateurs are invited to bring their special pieces of equipment. A large number of prizes will be awarded, the total value of which will exceed one thousand dollars. Many of the more valuable prizes will be awarded to those who win the various equipment construction and design contests.

Another of the innovations is the manner in which the prizes will be obtained. The donors of the prizes will be given a pro-rata refund of 75 per cent of the total net receipts. It is hoped that this refund will be ample to reimburse the donors for the actual cost of the prizes.

The registration fee is \$1.50, which includes the banquet ticket. Many of the better prizes will be reserved for those who send in their moneys previous to the opening of the conclave.

There will also be a 5-meter hidden transmitter hunt. Many new pieces of equipment will be demonstrated and all of the new receivers will be in action. Hotel rooms have been reserved for the prominent receiver manufacturers. Provisions have been made to install effective antenna systems so that all equipment can be demonstrated to best advantage.

There will be a "round robin" technical meeting. It will be a clearing house for questions asked by the audience. These ques-

tions will be answered by a group of more than ten well known technical men.

PROGRAM

Registration, 9 AM Saturday, February 23rd. 9 to 12 AM, trip to Tropical Beach, Sutro Baths.

1 to 5 PM, Technical Round Robin. Chairman, W6CAL. Speakers (15 minutes each), Charles Perrine, Jr., W6CUH; Al O'Neil, W6G1S; George Becker; Ralph M. Heintz, W6XBB; Clayton F. Bane, W6WB; Frank C. Jones, W6AJF; John L. Stevens, W6PW; W. W. Smith, W6BCX; J. A. McCullough, W6CHE; Charles Watson, W6DW; J. N. A. Hawkins, W6AAR.

7:30 PM, meeting of delegates of Federated Radio Clubs of Northern California. Visitors welcome.

7:45 PM, political meeting.

Sunday, February 24th

9 to 12 AM, Hidden 5-meter transmitter hunt and receiver demonstrations in hotel rooms.

1:30 to 3:30 PM, Two feature speakers.

3:30 to 5:30 PM, Amateur-built equipment contest.

7:00 PM, Banquet, entertainment and prize drawing.

Advance registration fees should be sent to W6JAL, Arthur Holmes, Secretary, 431 Lincoln Way, San Francisco, California. Arrangements have been made to accommodate 900 amateurs. Reduced hotel rates will be in effect. YLs and YFs are cordially invited.

• From Emil Guidici at Sheepbranch, California, comes word that ZS2A, South Africa, will be off the air indefinitely due to the passing of his mother. The amateur fraternity extends deep sympathy to ZS2A.

• W7CFJ H. P. Hoshi, 307 15th Ave., Seattle, Washington, wants the QRA of OA4AI in Peru. He worked this station on February 24, 1934, but can't find the QRA. If any reader knows the whereabouts of OA4AI, he is kindly requested to communicate with W7CFJ.

• Australian amateurs have a few ten meter (and five) enthusiasts among their number, and a constant watch has been kept on ten for three or four years by one or two. As this time of the year produces the best results on this band, activity has been increasing during the past week-ends.

Sunday, 25/11/34, proved to be exceptional. In Sydney, VK2LZ, 2HZ, 2NO and 2YC were on the air from 9 AM. VK4BB in Maryborough and VK4XN started to romp in and were speedily QSO'd by the VK2 gang. Whilst VK2NO was QSO VK4BB, the latter suddenly broke off and started calling ZL1BA. He hooked the ZL and subsequently told me that the reason was because the ZL's signal swept across the band in the process of tuning at QSA5 R8. VK4BB followed the signal to see who he was and nearly fell off his perch when he found it was a Maoriland. This was exciting because we have been looking for ZL's on ten for a long weary period. Shortly

after this, VK6SA in Perth, 2000 miles across Australia, began to come through at good strength and the two VK4's landed him. The chief interest at VK2NO was that just after this, K6EWQ's harmonic was heard at QSA4 R4 calling CQ and subsequently working an LU7. This was at 11 AM our time. It was only when K6EWQ started working the LU that I realized it was a harmonic. Surely this shows that conditions are becoming favorable for trans-Pacific working again on ten. VK4BB and 4XN had a great day. They worked several VK2's 3's and 6's. This kind of thing hasn't happened since 1928. In December, January and February, a VK-ZL ten-meter contest is running. Here is an opportunity for your ten-meter exponents on the West Coast to look for us. The contest will be confined to the Sundays, our time, and will run from 8 AM to 8 PM. VK4BB has also heard J2IS on ten, so things are looking up.

All good wishes,
Don B. Knock,
Radio Editor, "The Bulletin" (VK2NO-2NU)

I. R. F. NEWS

NEW IRF MEMBERS: K7BND, W6ITH, W6CSX, W6RH, W6ICX, W6JWL, W6GVS, VE5EO, and VE5FH. We wish you many IRF QSOs!

• If you know of any YL operators, whom you think can qualify for IRF, we would like to get them pledged. It may interest the general membership to know the YL members of IRF to date:

W7AHJ—Esther Brunk
VE5KS—May Rose Sparks
W6EK—Flora Card
W6DHV—Mac Amarantes
W5BKV—Sally Walker
W7NH—Nellie Hart
W9LW—Lucia Mida
W6HEG—Harriett Gilbert
W6AET—Florence Jones

New Division Chief

• W1BZC, William Ellsworth, has been the Division Chief for the East Coast Division in the past, but has changed his QRA from Massachusetts down to Pennsylvania, and is now in the Capitol Division. Dr. John A. Stewart, W1SK, has very kindly accepted to succeed Mr. Ellsworth in the position of Chief for the East Coast Division. We wish him luck, as they have a fine Division of fine men.

Eastern News

• W8ELO: "Heartily in favor of east coast gang get-togethers as suggested in last LJ." W2CJP says, "Rehabilitation plan is FB, and it will be the biggest publicity stunt ever pulled for Amateur Radio." His frequency is 3547 KC.

5-Meter QRM Problem Solved!

• Farmer "Jinks" and his good horse, "January", have solved the perplexing problem of automobile ignition QRM on 5 meters. If you are troubled with auto noise, or if the 5-meter band in the big cities is overcrowded, do as the good farmer does. The radio inspector will then have an ell of a time finding your QRA.



The Evolution Of A Vacuum Tube

(With Apologies to W6AAR)*

By W. W. SMITH, W6BCX
Associate Editor, R/9

SALES Manager of Novacex Inc. informs Chief Engineer that what the hams need is an addition to the Novacex line of electronic devices that will fill the gap between the NG-210 and NG-211 transmitting tubes. Chief Engineer stays up all night trying to decide whether to first build the tube and then name it, or to name the tube and then build it. After going into conference with second pint of Old Crow† gets inspiration to call new tube the NG-210½. Office boy remarks that designation is very fitting, but reminds C-E that Feebeltron has a tube called the FB-479½, and confusion might therefore arise because they sound so much alike. Suggests to C-E that they call the tube the NG-73.

For rough draft of proposed tube, design department uses pantograph on drawing of NG-210, and brings plate lead out top of envelope.

Office boy takes home first experimental model of tube and reports after trying it in his TNT that the thing got "pretty red" with 93 watts input and the key held down. Chief had a TNT once, and found efficiency to be 47 per cent, so with 93 watts input the tube must have been dissipating 50 watts, he figures. Office boy discloses that his milliammeter has bad habit of sticking and getting loggy; therefore figure of 93 watts should not be taken too seriously. C-E replies not to worry about that, because he was not sure of the accuracy of the ratings on the carbon lamps he used for dummy load, and only guessed at normal brilliancy anyhow. So maybe a TNT was 69 per cent efficient instead of 47 per cent.

Janitor asks C-E why he doesn't run static test on the tube to determine how much it will dissipate without getting too red, instead of fussing around with TNTs. C-E shuts him up by giving him second experimental tube to take home with him to play with, and then rushes off to lab to see about the matter of static inputs. Janitor reports next morning that tube gets fairly blue at 1250 volts.

Advertising department releases advance data on new NG-73 along with tentative ratings: Plate dissipation (max.) 50 watts. Plate voltage (max.) 1250. Oversupply of 210 filament stock results in tube having 1¼ amp. filament, 15 volts to give necessary watts emission. Shop foreman's son reports that he had 1500 volts on one for 5 minutes and it didn't blow up or go soft, so rating is changed to read 1500 maximum plate volts.

Charlie Perrine writes in and says that he obtained 231 watts output from an NG-73, with a note that if grid lead were brought out side so a 203-A driver could be used without the NG-73 flashing in the base, and the tube were pumped harder to allow 2800 volts on the plate instead of the 2200 he was using, it would be possible to get 239 watts output without exceeding the dissipation rating. Chief Engineer after reading letter five times announces that he has, after much scientific research, decided to scrap current design and change mechanical construction. He carries the idea one step further and brings not only the grid lead out the side, but also the filament leads out the other side. Notices that pins on base are not connected to anything, so decides to

throw base away. Discovers difficulty of mounting tube which has no prongs, so decides to put base back on.

Remembers about remark that tube should be pumped harder. Makes memo to put more "getter" in the tubes and increase the size of the envelope to allow cool spot of glass at bottom of tube for gases to collect on. President sends him memo never to use a preposition to end a sentence with.

Tube now handles 2800 volts without celebrating Fourth of July. Assistant Engineer notes new size of envelope and remarks that it is now large enough that if cooling flanges were put on the plate, the dissipation rating could be raised to 75 watts. "Improved" NG-73 makes its debut, sporting new corrugated-carbonated plate with cooling flanges giving the anode the appearance of a burned drug-store waffle wearing flippers. Data sheet states 300 watts input now permissible in high-efficiency circuits.

Skroo Loos, W5NUT, takes antenna off his Perrine rig to show visitors how he can draw off a 7-inch arc, and blows NG-73 through roof. Writes to factory saying tube sure enough "NG" all right, and asks why bother to put the 'ex' on "Novacex"? Does not think it necessary to mention small matter of plate voltage of 3200 and removal of antenna.

W6AM writes in that tube gets very hot with 300 watts input, which should be permissible according to ratings. Does not notice that he has mixed up coils on trick Don Wallop coil-changing scheme and is using 20 meter coil on 40 (resulting in very high "C"), as he has become far-sighted from trying to point out to visitors the trade mark on "Q" antenna atop his new tower.

W4SOS writes in plate ready to melt at 250 watts input, but neglects to mention that tube was running self-excited on 1½ meters. After mailing letter finds that the tube wasn't on 1½ meters after all, because the tube wasn't even oscillating. Decides to keep discovery to himself and lets letter ride.

W7RAZ forgets to remove shunt from milliammeter, and writes very derogatory letter about tube being over-rated. Visiting ham notices shunt and calls it to his attention, but RAZ remarks that the tube probably isn't any good anyhow, and that even if it were good he wouldn't like it.

Adjustment department gets tired of replacing tubes and answering complaints, so advises engineering department to make the tube huskier so that the hams can run 300 watts input, and not just 300 Perrine watts input.

Plate is made larger to handle more heat, and spacing is increased to raise breakdown and keep interelectrode capacity at approximate rated value. Proving laboratory finds tube okay except plate resistance now twice original value, which is corrected by putting in a huskier filament, now drawing 4 amps. instead of 1¼ amps at the same 15 volts.

News leaks in through grapevine that Feebeltron is about to release a tube with a mutual conductance of 9237 as compared to 3879 mmhos. for the NG-73. Chief decides that too much plate is hiding from the filament. Designs phantom grid structure to cut down shadow and raise mutual conductance. Research department brings in tube in which

no grid can be seen at all. C-E compliments research department, and then notes they carried things a bit too far by leaving out grid altogether. New Novacex high voltage rectifier for cathode ray equipment announced; appearance is suspiciously similar to the NG-73.

Chief decides to quit playing with ghosts and leave grid structure as originally planned, and to raise mutual conductance by putting in still more filament. New 8 ampere filament radiates so much heat that envelope melts with no plate input. Envelope glass changed to Stonex.

President's son decides to build himself a ham rig using low level modulation with a pair of NG-73s as linear amplifier. Because of comparatively low efficiency, finds that output is limited by plate dissipation long before maximum allowable plate voltage and plate current are reached. Instructs dad to instruct C-E to put flanges on the cooling flanges to increase dissipation rating. New NG-73 is announced, more suited to low-level and grid-modulation as dissipation rating has been raised from 135 to 165 watts, without change in other characteristics.

Letter from Perrine states that at 4600 volts he finds it possible to run 2800 watts input to a single NG-73§ without the plate getting much more than a vivid red if keyed with light enough dots.

Engineering staff compliments itself on new tube, and celebrates occasion by opening case of Old Crow. President opens letter from field man advising him that what the hams need is a tube that will fill the gap between the NG-210 and NG-211. President has idea for new tube. Chief Engineer has delirium tremens.

§ As measured in a dummy antenna.—Editor.

This R-S-T System

THE readability, audibility and tone system now used is the standard of the world, and has worked out very well. In fact, almost everyone is well satisfied with its meaning, except the A.A.R.S. and N.C.R. stations who have been using a S-1 to S-5 scale. All have learned to give correct reports by the QSA system, so why change to the R-S-T method?

In the October QST, W2BSR outlined a new system, which has been approved by the ARRL and is in use at W1MK.

In a letter received from Mr. Handy, Communication Manager of the League, he says: "THE OSA SYSTEM IS PART OF THE SUPPLEMENTARY REGULATIONS (MADRID CONVENTION) AND WILL ALWAYS BE IN USE INTERNATIONALLY, UNLESS CHANGED AT FORTHCOMING CONVENTIONS (CAIRO). THE R-SYSTEM IS WELL KNOWN, AND HAS EARNED HIGH AMATEUR REGARD."

In this case why does the ARRL try to start something new like this when, in the first place, they are encouraging the ham to break international laws in addition to getting the ham all muddled up with just another regulation?

I suggested that the signal strength portion of the R-S-T system be raised to 9, but Mr. Handy says this would involve very wide confusion at this time. Funny thing that he never thought of a "very wide confusion" when the League adopted the R-S-T system.

(Continued on page 32)

* See August 1934 QST.

† An old favorite of both receiver and vacuum tube manufacturers.

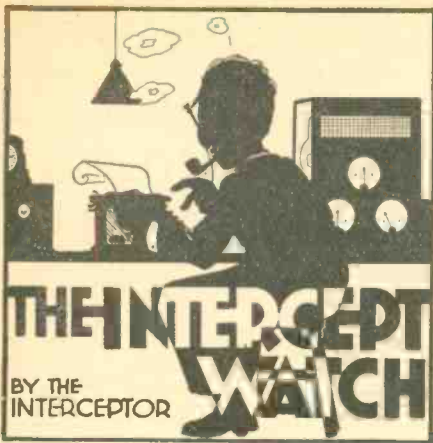

Here is a thriller, if ever there was one. Picture yourself in a lighthouse on the ocean. A storm breaks . . . your entire radio station is destroyed. What would you do to effect radio communication with the mainland? The Interceptor has intercepted a letter from F. L. Black, one of Oregon's SCMs, and attached to the SCM's letter was the thrilling story of how Henry Jenkins, first assistant Lighthouse Keeper of the Tillamook Rock Light off the Oregon coast, succeeded in building an entire amateur transmitter and receiver from salvaged pieces of junk—put the rig into operation and effected communication with nearby amateur stations. The Interceptor considers himself fortunate in receiving this thriller from F. L. Black and he hopes that all amateurs will profit from the reading of it.

● This record begins with the violent storm that swept the north Pacific, causing severe damage to the Light Station on Tillamook Rock on the 21st of October, 1934. At 10 P.M. October 20th, a fresh southeast wind was blowing with light rain. During the night the wind increased to gale force and changed to the southwest. About 3 AM October 21st the seas ran extremely high, swells hitting base of the rock from the southwest and the spray coming over the rock. At 9:30 AM I was awakened with a sudden jar, completely covered with water. All my clothes and bedding were soaked. The seas at this time were washing over the entire tower, pounding against the window shutters of my room. The window catch let go and the entire room was flooded. At this time the wind was blowing at an estimated 100 miles per hour or more, seas covering the Lighthouse, carrying with it large rocks, debris and fish which were smashed through the lantern plate glass, breaking 16 panes and flooding all quarters. In endeavoring to replace glass panes with emergency wooden shutters, Hugo Hanson's right hand was deeply cut. While assisting dressing his wound, I read the barometer which was 28.92 inches. Each time the tons of water would cover the building, coming down with terrific impact on the roof, the barometer would drop immediately to 28.72 inches, returning as soon as the impact was over.

Impacts from tons of water and rocks would occur most every three seconds, lasting from about 10 AM to 12 noon. Prior to that time they were not so frequent. About 10:15 AM a terrific impact occurred and the tower and building were enveloped with giant seas. The large 80-foot derrick and telephone cable had been swept away.

A 6-foot section of the west end of the rock was carried away, hurling rocks weighing as much as 50 pounds through tower and on the roof, smashing shutters which were made of ½-inch wood. The shutters at the base of the building were carried away, flooding all floors, breaking the piping of

the heating system and thereby cutting-off the heat which was badly needed at this time. We were all soaked, walking in cold water and extremely tired. The lantern and fog signal were now inoperative. Both of these were greatly needed by mariners. We had no other means of warning them. If we put out a different light, and if they would come up close enough to identify it, the consequences might have been disastrous. Nevertheless, a fixed white light was set up and a crude short-wave transmitter and receiver were built from parts of an old Atwater Kent broadcast receiver on hand at the station. We also had some batteries, scraps of tinfoil, copper and brass.

At 6:50 PM, October 23rd, I made the first call for W7CXX and was picked up by a Portland amateur, Merrill Peoples, W7WR, who was QSO W7CXX and who notified Henry Goetze, W7CXX, that someone was calling him. W7WR could not tell who was calling, because the signals were so weak and chirpy. A message informing the superintendent of the damage incurred was the first traffic handled.

When things around here got half dry, I immediately got two boards approximately 10 by 12 inches. Not having any tube sockets, I drilled holes in each board for sockets and took the two 30 type tubes out of the BC set and soldered leads on the prongs of the tubes.

On the transmitter board I placed a tank inductance which I made from some Bell transformer wire. The wire was wound on the cardboard case of a No. 6 "A" battery. I used 14 turns. The tuning condenser was a 3-gang condenser taken from the BC set, but I only used the middle section. I made the series fixed condensers for the antenna out of tinfoil and wax paper in which a loaf of bread had been wrapped. I used no grid condenser or leak. The plate blocking condenser was "swiped" from the BC set. I made the RF choke from one of the regular BC chokes by removing some turns. This junk, when finally assembled, completed a TNT circuit but used no grid condenser or leak. I took the batteries from the telephone and used them for lighting the filaments. Two No. 6 cells were connected in series. The three "B" batteries from the BC receiver were down to 80 volts. For a key I simply broke the battery connection with my hand. Later I found a piece of spring brass and made a hand key. I sent my first four messages with my fingers breaking the connection on the "B" batteries. But after that I used the home-made hand key. My transmitter antenna consisted of 40 feet of salvaged wire that was left from the BC set.

Not having anything to work with, the receiver was a crude affair. For the coil I found an old regular telephone receiver and I used the shell as the form on which I wound the 80-meter band coil. I used 45 turns of wire which I swiped from BC set. This made the grid coil. There were 20 turns on the plate coil. I had no means of controlling oscillation, so I put enough plate turns on the coil to keep it oscillating at all times. For the antenna series condenser I simply twisted two feet of insulated wire together and the capacity of the separation by the insulation served as the series condenser, between the grid coil and the antenna.

I used tinfoil condenser for the grid condenser, but I used no grid leak. The tuning condenser was made from two brass plates that I removed from the door knob. I fastened one plate on the receiver base and the other was separated by a piece of wax wrapping paper. Tuning was accomplished by shoving one plate over the other with a pencil. The values of these parts were unknown, but due to my past experience I finally found the 80-meter band and the first

station I heard was W7RT in Seattle. Then I knew where I was, and I immediately tuned with the aid of a pencil. I found W7CXX working W7WR, so I left the receiver tuned on W7CXX and while he was transmitting I tuned my transmitter to his frequency by listening to him with my transmitter oscillating. At 6:30 PM October 23, I called W7CXX. W7WR informed W7CXX that someone was calling him, so that was the way QSO was made with the mainland and God's country. Shipping was warned through notifying the Superintendent of Lighthouses by sending message to Goetze, W7CXX, who relayed them to the superintendent at Portland via Western Union.

(Editor's Note—Box 215, Seaside, Oregon, is the address of Henry Jenkins, the man who wrote this story.)

The 222 Communications Receiver

(Continued from page 15)

while, since it allows adjustment of the resonant antenna coupling so as to obtain optimum value of first detector regeneration. It can be used with any type of antenna and the latter may be tuned to resonance externally and the optimum coupling easily found. The results were very gratifying. The image interference on 40 meters measured 60 DB units down in level from the desired signal, using a signal generator for these measurements. 60 DB means an image rejectivity of 1000-to-1, which is extremely good for sets using a good stage of RF. The image measured 50 DB down on 20 meters, which is more than most superheterodyne receivers can even approach at that wavelength. The receiver has practically no image whistles of "phantom" commercial signals in the amateur bands, unless the commercial signal is of very high field intensity. The signal generator gave an audible signal in the headset with an input of 130 DB down from 1 volt, which is less than one microvolt input. This is ample sensitivity, with low internal receiver noise level, to reach down into the atmospheric noise level in any locality.

The receiver was built into a metal cabinet measuring 8½ inches deep, 7 inches high, and 11 inches long. The front panel is 7 inches x 11 inches of No. 12 gauge aluminum. The chassis is also of No. 12 ga. aluminum, bent in the form of a U, two inches deep and 8¼ inches wide by 10 inches long. All of the necessary tube socket and dial holes can be punched, or cut out with a circle cutter and drill press. The shield partition between the oscillator and detector is also of No. 12 gauge aluminum, 7 inches long, 4¾ inches high with a ½-inch lip along the bottom for fastening to the chassis with 3 machine screws. In building this set it is a good plan to take all of the larger parts and set them on the chassis so as to get the proper chassis layout before drilling. The pictures of this set and the plan drawings should enable anyone to duplicate it without trouble. The lower knobs on the front panel from left to right are sensitivity, regeneration, audio volume, tone control and BFO switch combination, and antenna coupling. The upper row: oscillator band setting adjustment with knob and small 0-100 metal escutcheon plate, main tuning control, and last, the detector band setting control and 0-100 division plate. The antenna leads, power cable plug and telephone jack are at the rear of the chassis with large holes around them through the metal cabinet. The cabinet has a hinged lid.

The receiver is simple in its circuit and easily built. It can be, and was, in this case, built and put on the air in two day's time. The circuit line-up is simple if a modulated oscillator is available for lining up the IF amplifier. If not, it can be aligned by using the noise level from a large antenna.

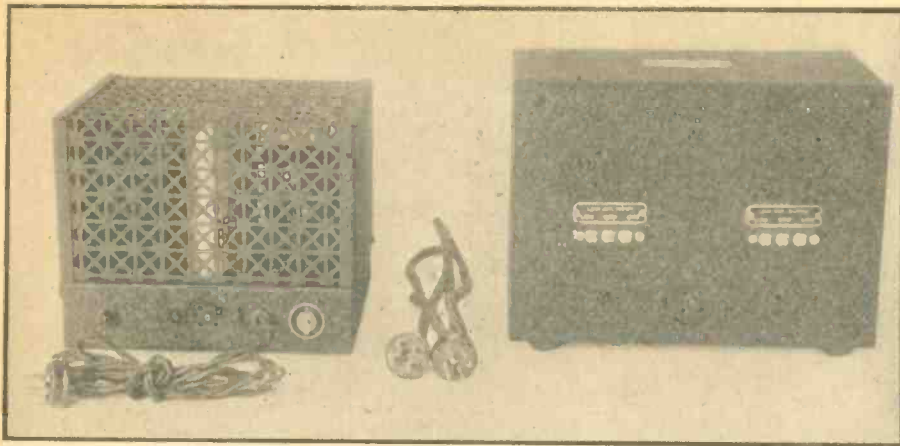

Front and Rear Views of the Amplifier in its Metal Housing.

ing with a high-gain amplifier system that no possibility can be overlooked.

A special transformer was made with all the windings electrostatically shielded from each other. When this transformer was installed, about 90% of the remaining hum disappeared—a most gratifying result.

The remaining hum was definitely cathode-heater hum, and its elimination was merely a matter of tube choice. It was found that

6C6s were by far the quietest, the 57 being quite noisy.

With the hum brought down to the point where an experimental pre-amplifier feeding a 15-watt power amplifier was just as quiet with the power switch on or off, the next problem was that of gain, which, after all, is what the amplifier was built for in the first place. The gain must be 40 db or more if a 70 db amplifier is to be driven with sufficient reserve. The circuit of Fig. 1 had only about 38 db gain, which was not enough for a velocity mike. An extra stage did not prove successful because of terrific microphone effects. The final circuit chosen for a commercial wide-range high-fidelity pre-amplifier (Lafayette) is shown in Fig. 2. The first 6C6 is operated as a triode, the second as a triode. The overall gain was found to be 62 db.

The final problem was frequency response. Curve 1, of an amplifier using the two triodes of a 79 in cascade with good transformers, is shown to illustrate how tube choice can affect amplifier performance. The impedance of the input transformer secondary in this case is about 100,000 ohms. Curve 2 shows the same transformer with a pentode and pentode-triode combination. The reflected input capacity of a triode is influenced by the mutual conductance of the tube; with a pentode it is the actual input capacity as determined by the mere physical construction of the tube.

The practicability of using a pentode first-stage amplifier was a bit of luck, from the standpoint of microphonics as well as frequency response. The high gain makes an intermediate stage unnecessary.

The amplifier response represented by Curve 2 was still not ideal for a high fidelity mike. The possible frequency losses in the amplifier were investigated, and the transformers under ideal conditions were found not to possess the discrepancies shown in the curve. It was also found that a response varying only 1 db from 30 to 17,000 cycles was obtained with the input transformer eliminated and the test input fed directly to the grid circuit of the first amplifier. The input transformer was then held responsible, but since it showed no such loss as mentioned under ideal conditions, the blame was placed on the distributed capacity of the tube, its wiring, etc. To lower the distributed capacity of the transformer secondary, and also to reduce the shunting effect of the tube, the secondary impedance was reduced from 100,000 to 40,000 ohms. The final frequency response as shown in Curve 3 is believed to be as good as anything obtained heretofore.

The gain suffers with reduced secondary impedance, but the final amplification of 56 db (instead of 62 as originally measured) proved altogether sufficient.

As the output transformer is worked at



Ham Hints

— By JAYENAY —

Eliminating the Chirps When Keying the Crystal

● In the conventional pentode crystal oscillator circuit the screen voltage is obtained from the plate power supply by means of a series dropping resistor. When an attempt is made to key in the center-tap of this crystal oscillator circuit, a bothersome chirp is usually found in the note. When the key is up the screen voltage rises to the same value as the plate voltage, which is from 350 to 450 volts. With the key open, no space current flows through the tube and because there is no current through the screen dropping resistor, there is no voltage drop across that resistor. The high voltage is thus applied to the screen. When the key

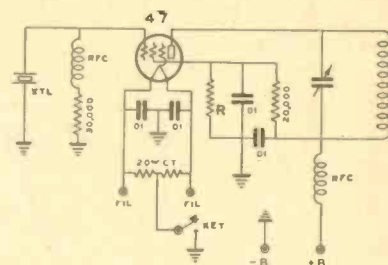

R=5000-10,000 OHMS, (TO GET APPROX 100 VOLTS ON SCREEN)

is pressed, and space current starts to flow in the tube, the screen current causes a voltage drop across the usual series dropping resistor and the screen voltage then drops back to its normal 100 volts. However, it does not drop back instantaneously; during the time the screen voltage is dropping there is often a very noticeable change in the frequency, which causes the chirp. The chirp can be eliminated by keeping the screen voltage approximately constant, whether the key is up or down. This necessitates the use of a voltage divider, instead of a series dropping resistor as a source of screen voltage, as shown in the circuit above. The value of the resistance R should be chosen so that the voltage on the screen, when the key is down, is 100 volts when measured with a high resistance voltmeter.

low impedance values, no difficulties with frequency discrimination were experienced with it.

Most of the preceding discussion has been of the electrical features, but the mechanical construction is also of extreme importance. The completed amplifier is shown in the accompanying photographs. Nothing less than 1/8 inch structural steel is used throughout. The pre-amplifier components are mounted on a chassis that slides into sponge rubber guides inside a heavy cabinet measuring 10 1/4 x 7 1/4 x 5 1/2 inches. The front panel, containing the input and output connections and power receptacle, is screwed to the corners of the box, not to the chassis. The latter thus floats perfectly free. The whole unit weighs 25 pounds and nothing short of a deliberate kick affects its microphonically.

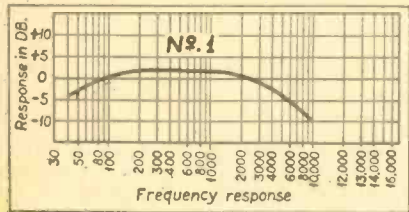

Frequency curve of pre-amplifier with 79 triodes and ordinary transformers.

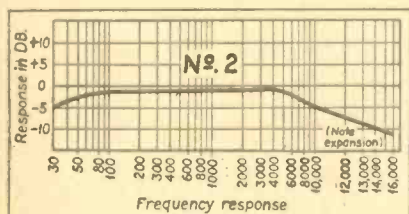

Frequency curve of pre-amplifier with 6C6 pentode and 6C6 triode connection, and ordinary transformers.

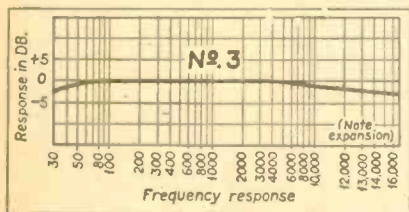

Frequency curve of pre-amplifier with special transformers.

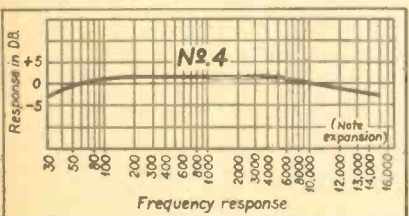

Response of entire system illustrated in Fig. 3 and Fig. 4.



McMURDO-SILVER

Receiver Prices . . . and Plug-In Coils

Apparently the page of rambling appearing in the December issue of RADIO proved of some interest, to judge from FB cards and comments some of you readers were kind enough to mail in, so here goes for a bit more, mostly on the subject of prices of amateur receivers.

Today there are not one but several good amateur superhets with and without crystal filters available or almost ready below one hundred dollars—in a word at fair prices in terms of design, material and performance. This is as it should be, but the fact that you can now buy a good superhet at a price comparable with good all-wave broadcast receivers—and some of these latter equipped with band spread tuning and beat oscillators are actually better ham receivers than have been available to amateurs as specifically amateur jobs—is largely due to the entry of cost conscious makers into the amateur market.

The point is that amateur receiver design technique has been greatly aided by the all-wave broadcast flurry. So much so that the amateur market looks good today to some of the b.c.l. makers, and in consequence amateur radio is finally getting a break on receiver costs—a break made possible by the cost knowledge of makers who have had to meet serious price competition to live.

The plug-in coil situation is a good example—lots of them cost money—much more money than more convenient, and I believe better, permanently installed coils with a good switching system. And usually in cost lies the hope, if not the actuality, of maker's profit. No, none of us are in business for love alone, although we don't make a nickel net on 5C receivers, though we do have a lot of fun. But if you want to spend over one hundred dollars for a receiver, the dual xtal filter MASTERPIECE III-X is the answer to the super fine receiver question.

And speaking of plug-in coils, there finally seems to be a trend away from them in transmitters—to tapped coils such as the commercials have used for years. This seems quite sensible and I've recently done some checking on the subject of losses in tapped coils in transmitters. The answer was as expected. The losses are measurable, but just measurable, and even if they ran up to 5%, which they don't in a good layout, 5% power isn't much in decibels to the receiving operator when compared to convenience and permanence. Our 10F transmitter is a good example of economy and efficiency—10, 20, 40, 80, or 160 meters by shifting clips on permanently mounted coils. Why not try it in your own rig—you'll be surprised, whether you leave your coils open ended (we prefer it so) or short circuit unused turns. Tnx-cul.

McMurdo Silver

WE PRESENT **PATTERSON** IT'S All-Wave Radio READY

THE NEW PR-12 PROFESSIONAL RECEIVER

—PATTERSON'S MASTERPIECE—THE ULTIMATE FOR 1935
IN THE SCIENCE OF DX COMMUNICATION

- 8 to 550 Meters
- Shielded 100%
- Preselector Stages
- Self Contained Power Supply
- Large 10 1/2" Dynamic Speaker
- Crystal Filter
- SS CW Tuning
- Chromium Plated Chassis 18-gauge



- New 6 Section Tuning Condenser
- Three Stages AF Amplification
- Doublet or Marconi Antenna Connection
- Monitor Switch
- Modulation Meter and "R" Meter
- Litz Wound IF Transformers 6 Months' Guarantee

TUBE LINE UP

- 1—6D6 Radio Frequency Amplifier
- 1—6A7 Combination Oscil. & 1st Detector
- 2—6D6 Intermediate Amplifiers
- 1—75 Diode Detector
- 1—75 First Audio Amplifier
- 1—76 Second Audio Amplifier
- 2—42 Class A Prime Output Rectifier
- 1—5Z3 Beat Frequency Oscillator
- 1—6D6 Modulation Meter and "R" Meter

Production of this custom built receiver will be strictly limited. Orders will be filled in the order of receipt. Order at once to avoid delay.

F.O.B. WILMINGTON, DEL.
OR LOS ANGELES, CALIF.

PRICES COMPLETE
ABSOLUTELY NOTHING ELSE TO BUY

NO TIME PAYMENTS
OUTSIDE U.S.A.

	List	Net Cash	Time	Down Payment	Monthly 5 Pmts
Chassis, Tubes and Speaker without Crystal.....	\$129.50	\$77.70	\$84.18	\$34.18	\$10.00
Chassis, Tubes and Speaker with Crystal.....	139.50	83.70	90.75	35.75	11.00
Metal Case, Complete, without Crystal.....	139.50	83.70	90.75	35.75	11.00
Metal Case, Complete, with Crystal.....	149.50	89.70	97.25	37.25	12.00
Console, Complete, without Crystal.....	169.50	101.70	110.20	45.20	13.00
Console, Complete, with Crystal.....	179.50	107.70	116.70	46.70	14.00

DELAWARE RADIO SALES CO.

405 DELAWARE AVENUE WILMINGTON, DELAWARE

ESTABLISHED 1920 (Prices and Terms Subject to Change Without Notice) ATTENTION W3DQ
N.Y.C. Branch: 136 Liberty St.—W2KR Canadian Representative: J. L. Walker—VE3JI—Rockcliffe, Ont.

I Voted "No"

(Continued from page 7)

still more "representation" of the same kind! No, if a director is competent he can represent on the board 10,000 members just as well as 1,000. On the other hand, if TEN directors are incompetent, or cajoled, or coerced, or mesmerized, the whole lot of them couldn't represent the big toe of one real amateur! In 1932 Warner had a plan for re-divisioning the whole country. He strongly urged the directors to approve it. It actually added one new state to the Pacific Division! That was two years ago—before headquarters knew Culver. Hi.

Before I would consider for one minute the desires of the secessionists I should want the opinions of such old-timers and experienced Southern Californians as Dr. Waters, W6EC, Lee Porter, W6AKW, Bert Sandham, W6VO, Hal Nahmens, W6HT, James Brown, W6VH, Mel Wood, W6AVJ, and many more of these wise heads I could name if space permitted. If any men of this class believed it a wise move to disrupt the division I should listen with close attention. My guess is that they would not countenance such a move. My next guess is that if this matter comes to a fight, all the intelligent hams of the South will line up with the solid North to prevent the despoilment of our Pacific Division, the greatest in the United States.

Grown men know that in any organization that depends for its effectiveness on solidarity of aim any move that tends to destroy that solidarity is suicidal. It is the great weakness today of the amateurs of America that they have done everything they could think of to keep themselves disorganized by disjoining themselves into more and more warring units. The theory of the hams seems to have been that the more "organization", the more "government", the more "control", the more contested elections, the more internal strife, the better would be their chances of combatting the common enemy. Their belief seems to have been that, given "organization" enough, they could get along without brains and experience. So that now amateur radio is staggering under such a tremendous load of so-called organization it has no time for anything except trying the impossible—to make this monstrous machine function for the good of the amateur members of the ARRL alone. The ablest administrators in the world could not devise and operate organic machinery for an organization composed partly of amateurs and partly of commercial people who have no use for the amateurs except to exploit them. The amateurs have indeed come to a sad estate. They have ended by being absolutely without organization and without leadership. They have today—actually—less of real organization and less of real leadership than the Girl Scouts. And this Little ARRL, Inc., now proposes to keep up the ham tradition by making the disorganization still more pronounced!

The Pacific Division is the most prominent division of them all. It is generally so acclaimed throughout the country. It is looked up to by amateurs of other divisions as the leader in the fight for a square deal for ALL amateurs. It has earned this prominence by working and fighting steadily for years towards the goal of a league we can call "amateur" without lying about. And now along comes this Little ARRL, Inc., and coolly proposes to destroy this great division! Either they stupidly conceive themselves as the rulers of a small division all their own, (which I do not believe is the case), or else they are working by the suggestion of people who have good cause to fear that the courage and energy of the Pacific Division

(Continued on page 34)

LEARN CODE QUICKLY

AND EASILY AT HOME.
THE
INSTRUCTOGRAPH
Enables You to Practice
ANY TIME - ANY WHERE
ANY SPEED



The most practical method of learning the code on the market today. Leading schools and the Government use tape machines because there is nothing better.

A SMART INVESTMENT because it is priced low (cash or terms) and built to last indefinitely. Highest quality throughout.

Start now with the aid of an INSTRUCTOGRAPH TO QUICKLY MASTER THE CODE and send intelligently with the best of them.

Can be rented as low as \$2.00 per month (3 mos. or more). A post card will bring full information.

INSTRUCTOGRAPH CO.
915 LAKESIDE PLACE CHICAGO



NEW EDITION
Now Ready

The only Radio Call Book published that lists all of the radio amateurs throughout the entire world.

Also a complete list of high frequency commercial stations, international abbreviations and amateur prefixes, "Q, R, & T," systems for reporting signals, New US radio inspection districts, high frequency press, time and weather schedules, and high frequency commercial stations listed by frequencies.

Every ham should have one. Always up-to-date. Single copies \$1.25. Annual subscription \$4.00.

RADIO AMATEUR CALL BOOK, INC.,
600 SOUTH DEARBORN ST. CHICAGO, ILL

RADIO CLUBS are entitled to special group subscription rates to "RADIO." Write for details.

RADIO REPAIR MEN—AMATEURS

Sears, Roebuck and Co., The World's Largest Mail Order Company (in the Radio and Parts business for almost 20 years) announce for restricted distribution a new Radio Parts and Amateur Equipment Catalog.

24-HOUR SERVICE

Everything carried in stock—the broadest guarantee ever written—Complete satisfaction or your money refunded.

Write today for catalog No. 63 R 61. We will put your name on our mailing list and send you this big, new catalog as soon as it is off the press.

SEARS, ROEBUCK and CO.
CHICAGO, ILL.

LENZ MICROPHONE CABLES

are constructed for perfect transmission of voice and sound. Eliminate man made interference and "HUMS."

Perfect
for Short
Wave



Shielded Rubber
Covered

A New Item That Is Popular



CRYSTAL
MICROPHONE
CABLES

For Sale by Leading Jobbers and
Dealers Everywhere

West Coast Representatives

FRANK A. EMMET

741 S. Burnside Ave., Los Angeles, Calif.

LENZ ELECTRIC MFG. CO.

1753 N. Western Avenue, Chicago
Please send me your new Catalog No. 21

Name _____

Address _____

City _____ State _____

QUALITY

at a Price You Can Afford to Pay!

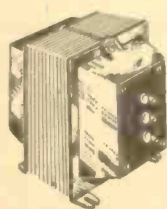

FRANKLIN Transformers

Very conservative ratings on Transformers and Chokes for every Amateur Station.

"MOST SOCK
PER DOLLAR"

Write for Catalogs

FRANKLIN TRANSFORMER MFG. CO.

607-609 22 Ave. N.E., Minneapolis, Minn.

will upset their private racket. The game looks like the old one: always split the opposition if you can and get them involved in an internal fight of their own. That is good political tactics and it has been employed time and again in the ARRL. If the instigators of this especial occasion think the fight that will result from any attempt to disrupt and despoil the great Pacific Division will leave them unmaimed they are badly mistaken.

Clair Foster, W6HM.

COL. FOSTER'S IDEA OF A RETROACTION

Some Excerpts From a Letter To W6GTE

Dec. 13/34

W6GTE:

THANKS for your very straightforward letter of December 11 regarding my yarn in December "RADIO". I know it takes considerable courage for a youngster to get up and paste a man of my years of experience in a hardboiled world, but I'm such a great admirer of courage—and I see so damn little of it among hams—that I positively LOVE the man who displays some of it, even when I myself am the object of his wrath.

Which being said I am now at liberty to tell you that aside from its frankness and its clarity of expression there is no other quality in your letter that commends it to me. Its animus is obvious—just from your first paragraph in which you refer to my quotation of Schnell's remarks as "the alleged statement of Fred Schnell's". You had read in the December "RADIO" article that I had taken the Schnell statement from the stenographically recorded proceedings of the ARRL board meeting at which it was made. The term "alleged" might well be applied to "minutes" of board meetings such as are printed today but could hardly apply to statements appearing in proceedings recorded verbatim by court stenographer. So your choice of the word "alleged"—carrying the implication that you did not believe me—was gratuitous and indicative of your own state of mind towards me. Personal animosity cannot be concealed, in either talk or writing, from an experienced observer.

Approaching a subject with personal animus is about the surest way of confusing one's logic. For example, I cannot follow your reasoning when you conclude your letter with, "In the interest of fair play, Colonel, I believe that some sort of retraction is in order". I don't question the sincerity of that belief; to me it rings true. But I don't see how you conclude the retraction should come from me; or in fact that there is anything for me to retract. Schnell's remarks quoted from the record are clear and unqualified. If there is any retracting to be done it would seem to be on the part of Schnell himself.

This seems to be what caused you to conclude that a retraction was due from me: You say that on October 30 you asked Schnell whether he had made the statement in 1923 that less than 20 per cent of the ARRL members were licensed amateurs and that, "He flatly denied making such a statement". I am quoting you accurately, including the underscoring. Then, you say, Lansingh told him he was so recorded in the stenographic record of the board meeting of December 8, 1923. Whereupon, you say, "Mr. Schnell then stated that if he did say such a thing he had no recollection of it and in all probability referred to the percentage of ARRL members who were actively engaged in message handling".

(Continued on page 35)

AEROVOX

for DEPENDABILITY

IF you want that transmitter to stand up and deliver the goods year in and year out, with least cost to you, see that it's equipped with . . .



- AEROVOX Oil-Filled Transmitting Condensers . . . quality inside and out . . . latest engineering . . . remarkable performance . . . longest life . . . and irresistible prices (for example: 2 mfd. 2000 v. \$6.50 list!)
- AEROVOX Grid Leak Resistors . . . also for voltage dividers . . . adjustable contact slider . . . wire-wound, vitreous-enameled . . . heaviest duty work.
- AEROVOX Mica Condensers . . . precision units . . . bakelite molded . . . lowest dielectric losses . . . small in size and price but gigantic in usefulness.

And remember that Aerovox offers all other types of condensers and resistors for dependable, economical, trouble-free service.

New Catalog . . . 1935 Edition just off the press describes complete Aerovox line. Also free copy of our monthly Research Worker.

AEROVOX

CORPORATION

84 Washington St. :: Brooklyn, N. Y.

BIRNBACH Superior INSULATORS



BIRNBACH'S line of insulators and antenna equipment is the largest available. "Navy-Type" Insulators with center hole for anchoring transmission line, and the "Wing-Nut" Standoffs are popular new numbers. Strong, highly-glazed ceramic. Well-rounded corners and edges. Nickel-plated brass hardware. Write Dept. PR-1 for Data.

BIRNBACH RADIO CO., Inc.
143 HUDSON STREET NEW YORK CITY

STANDOFF

LITTELFUSES

Instrument Littlefuses, for meters, 1/200 amp. up.
Hi.-Volt Littlefuses for transmitters, etc. 1000, 5000 and 10,000 volt ranges, 1/16 amp. up.
Neon Voltage Fuses & Indicators (Tattletales) 100, 250, 500, 1,000 & 2,000 volt ratings.
Aircraft Fuses, Auto Fuses, Fuse Mountings, etc.
Get new Catalog No. 6

LITTLEFUSE LABS., 4503 Ravenswood Ave., Chicago, Ill.



"SO! you wont talk eh?"

"Where were you on the night of October 13th?"
Silent . . . silent as a door knob . . . Here's a tip,
Inspector . . . call a good serviceman and have him
bring along some Centralabs . . . chances are that's
all your SuperIodyne needs to make it tell all it
knows.

For a mere handful of Centralab Radiohm Replace-
ment parts will service almost every known make
of radio . . . and make it perk better than before.



The Sturdy
Fixed
RESISTOR



The new
patented
RADIOHM



The Efficient
MOTOR
RADIO
SUPPRESSOR

Centralab

Radiohms - Resistors - Suppressors

(Division of)
GLOBE UNION MFG. CO.
MILWAUKEE

Speed of Champs Now Within Your Reach

The CANDLER SYSTEM of learning the Code gives you
Speed, Accuracy and Ability. Be able to read fast press
and commercial stations as easily as you read your news-
paper.

Any skilled Amateur or commercial operator will tell you
that Candler Training is the best that can be had and that
Candler Trained students copy behind with "mill" or pencil.

The CANDLER SYSTEM is not just a routine of code prac-
tice, but an entirely different method that produces positive
results quickly.

Our leading Operators of today are Candler Trained. Get
started right so that you, too, can become a Champion.

Write for FREE bulletin, full of interesting items as well
as listing of stations broadcasting practice programs from
all districts. A splendid practice that
costs you nothing.



Ask for full information on how the CAND-
LER SYSTEM can give you the necessary
speed to enable you to secure the ticket
you're going after. Write now—no obli-
gation.

Get your speed where the Champions
got theirs.

CANDLER SYSTEM CO.
6345 So. Kedzie Ave., Chicago, Ill.

Schnell first denies flatly that he had made
any such statement. Then when he is re-
minded that a copy of the stenographer's
record had come to light he forthwith com-
mences to alibi by saying he has no recollec-
tion of it and that he probably meant some-
thing else. Hi. Well, if he had no recol-
lection of his statement just how, do you
conceive, he could have met your first in-
quiry by flatly denying that he had made any
such statement?

And the alibi is not credible. Hebert's
statement that first Bidwell and then Schnell
challenged was that it had been figured 10,000
of the then 14,000 members were licensed.
Not a word had been said about "active"
amateurs or message-handling amateurs—
either before or after Schnell's remarks. Now,
is it believable that Schnell is right in his
present recollection that eleven years ago he
didn't mean what he had said but was re-
ferring to something that wasn't under dis-
cussion at all! To a grown man it isn't be-
lievable.

The stenographic record of that meeting
of December 8, 1923, is quite complete. Even
the most insignificant remarks are recorded.
It makes a book about an inch thick. "Come
up and see me some time" and I'll show it to
you. It is full of disclosures that would be
intensely interesting to any present-day ham.

One more thing in your letter I'd like to
refer to. You say, "I personally am not
greatly worried over the number of com-
mercial operators in the ARRL ranks". Well,
who is? In the demand of the amateurs that
Warner disclose the number of licensed
United States amateurs there are in the ARRL,
nobody has said anything about "commercial
operators". If you are putting in the minds
of your hearers and readers the thought that
we wish to know how many of the ham mem-
bers are also commercial operators, then
the premise is entirely of your own making.
There are many commercial ops who are also
licensed hams; and they are just as much
hams as any of us. There are also many men
engaged in radio for a livelihood who are
licensed hams. When we refer to commer-
cials in the membership of this organization
that proclaims itself to be "amateur", we re-
fer to the thousands of non-amateurs who are
officials or employees of commercial com-
munications corporations—the people who
have wellnigh stripped the amateurs of their
rights and frequencies, the people whose
money is the chief support of the employees
at ARRL headquarters. We refer to at-
torneys for commercial radio people—such
as Paul Segal who is employed by commer-
cial radio corporations—the traditional ene-
mies of the amateurs—and who is expected
at the same time to be guarding the ama-
teurs against the encroachments of the very
people who employ him! We refer to manu-
facturers, non-amateur dealers, agents, job-
bers, distributors, advertising men, salesmen,
crooners and all the rag-tag and bob-tail of
commercial radio who join this "Non-com-
mercial association of radio amateurs" with-
out even a question as to their class, color
or citizenship so long as they cough up \$2.50
for a subscription to QST.

Now, if there is any retracting to be done
in the matter of my story in December
"RADIO" I suggest that Schnell is the man
to do it. He was a director on December
8, 1923, and has a copy of the record of that
meeting. No doubt he has read it many
times. If at this late date he wishes to re-
tract the statement in question he may do so
in any form he may devise and we will see
that it gets wide publicity. If QST won't
print it, "RADIO" and "R/9" will.

While you were going over my December
story looking for some statement to rub my
nose in, how come that you decided that a

A-T CUT CRYSTALS

Mounted in Special Power Holder



Introductory Price\$5.95

See Your Dealer
MONITOR PIEZO PRODUCTS CO.
2802 W. Ave. 32 Los Angeles, Calif.

Midwest

... offers complete
stocks . . . fast service
. . . practical advice
on amateur problems

MIDWEST
stocks ALL
these
worthwhile
lines:

- NATIONAL
- JOHNSON
- SYLVANIA
- RAYTHEON
- RCA-
DEFORREST
- THOR-
DARSON
- HAMMAR-
LUND
- WESTON
- TAYLOR
- BLILEY
- OHMITE
- SIGNAL
- AEROVOX
- CARDWELL
- ELECTRAD
- CORNELL-
DUBILIER

Midwest offers the ama-
teur the most complete
and reliable service ob-
tainable anywhere.

Complete stocks of every
worthwhile line are al-
ways on hand—ready for
instant shipment to any
part of the world.

Members of Midwest's en-
gineering staff operate
Station W9RTV to an-
alyze amateur transmitting
needs. Their sound advice
on all amateur problems
is yours for the asking.

Midwest's famous 4 hour
Service applies to EVERY
order. Within 4 hours of
the time your order for
equipment is received, it is
on its way to you!

Send for This Big
Winter Catalog!

Send now for your FREE copy
of the world's biggest catalog
of short wave transmitting
and receiving equipment.
Mail the coupon TODAY!

Midwest Radio Mart

520 South State Street
Chicago Illinois

Please rush me your Big
Winter Catalog.

Name _____

Address _____

... and
every other
recognized
line

New



**ELECTRAD
VOLUME CONTROL**

You Can't Hear Noise Because It Isn't There

THE resistance element is baked on the flat outer rim of a rigid Bakelite ring. Over this, the special-alloy floating contact gently glides in a straight path.

Result: The smoothest, quietest, long-lived volume control ever devised. Absolute quiet is further guaranteed by individual testing of each control at the factory.

The molded Bakelite case, with removable metal end-cover, projects back-panel only 1/2 inch, when mounted. New-type power-switch (approved by underwriters) attached by a single screw. Extra-long, easily-cut aluminum shaft. Made in all standard sizes.

Guaranteed QUIET

Write Dept. PR-1 for Descriptive Circular and the New 1935 Resistor Catalog.



FRANK C. JONES

JONES

Consulting Engineer

Special High Frequency and Ultra High Frequency Equipment Designed and Developed for Amateur, Military and Commercial Communications.

2037 Durant Ave.

Berkeley, Calif.

defense of Schnell was necessary rather than a defense of the ARRL officers? It was the ARRL officers that the story showed up; it did not in the least question Schnell's statements or conduct. What the story disclosed was a new all-time high in mendacity by the ARRL headquarters in their writing to an amateur, "All voting in ARRL affairs is now restricted to licensed amateurs". This glaring affront to the truth seems not to have caused you any uneasiness.

Let's look at the probable reasons why you jumped to the defense of Schnell, who needed no defense at all, while you failed to defend Warner who needs a hell of a lot more than you or anyone else will ever be able to provide. You have started to take me apart, OM, and you ought to know by this time that I can be depended upon to finish anything the other feller starts.

You are the secretary of the group that calls itself, "Federation of Radio Clubs of the Southwest, ARRL, a California Corporation". Which sounds big, at any rate. A group that is widely known to be backers of K. B. Warner. Your group publicly supported Warner in his failure to report the truth of the Madrid convention's new restriction on amateur stations. It approved this restriction that aimed to kill the greatest public service the amateurs of the Pacific Division provide—the trans-Pacific traffic. Your group was AGAINST the efforts of those amateurs who were working to prevent the ratification of that restriction.

It is your group that has been working up interest in getting the southern half of the Pacific Division to secede and form a separate division. It was Matney, W6EQM, the ranking officer of your association who proposed this disruption of our division at the Fresno convention in November. It is common knowledge that your group has sided with the ARRL officers against all the amateurs of the United States who are endeavoring to clear the ARRL of certain abhorrent and destructive practices and that the officers welcome your assistance. It is well known that while the ARRL officers failed to send a headquarters man to the last Pacific Division convention—sponsored by the San Jose Club—they did send one, Warner's right-hand man, to a hamfest arranged by your group since then. The first instance of a headquarters man being sent clear across the continent to a mere hamfest. It is well known that this same man, Budlong, spent much of his time with the officers of your group on a more recent trip to this coast. Perhaps you will tell us that all of these significant circumstances have nothing to do with your reason for ignoring the chief theme of my December story—this latest audacity of the ARRL headquarters.

I am glad you wrote me when and as you did. I was just writing my story for January "RADIO". Your letter provides some additional ideas. You will recall that when I voted "NO" on the Matney proposal I was asked if I would be willing to give my reasons and that I replied I would do so in writing. I prefer to do my talking in writing or print rather than orally. That's what constitutes my story for "RADIO"—if the publisher sees fit to use it. I like to say my say with black and white; then if I pull a boner the gang can nail me to the mast. Incidentally it guards against misquotations, although being misquoted does not worry me. We are all misquoted at times. There are only two kinds of men who escape it—those who never open their mouths and those who never say anything worth listening to.

Thanks again for a letter that while it stirs my risibilities I am bound to concede, nevertheless, is temperate and courteous.

73,

CF W6HM

AMATEUR ALL STANDARD LINES HEADQUARTERS WE SERVE YOU BEST.

SEND FOR THIS CATALOG!
IT LISTS EVERYTHING FOR SHORTWAVE
TRANSMITTING AND RECEIVING

Aerials
Chokes
Coils and Forms
Condensers
Crystals and Holders
Dials and Knobs
Insulators
Jacks, Plugs
Keys - Meters
Monitors



Oscilloscopes
Power Packs
Preselectors
Relays
Receivers
Resistors
Sockets
Transformers
Transceivers
Tubes - Tubing
Wave Meter

NEW EQUIPMENT

Receivers:
NATIONAL "HRO"
RCA-ACR 136
Hammarlund "Super Pro"
SUPER SKYRIDER

Transceivers:
NATIONAL
HARVEY
HAIGIS
KNIGHT

New Antenna Gear—New Tubes—and the complete National line. Write for This Catalog

Allied Radio

ALLIED RADIO CORPORATION
833 W. Jackson Blvd., Chicago, Dept. J.
Send me our FREE New 1935 Catalog with the complete Amateur Listing.

Name
Address
City State

PROVEN DEPENDABLE PROFESSIONAL BAND SPREAD DX5

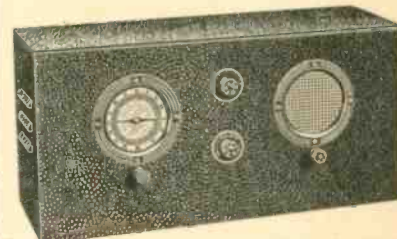

- BUILT-IN DYNAMIC SPEAKER
- CONTINUOUS BAND SPREAD
- SELF CONTAINED AC SHORT-WAVE POWER SUPPLY
- 5 DISTINCT WAVE BANDS
- ALL WAVE
- BUILT-IN COIL HOLDER RACK
- HIGH SENSITIVITY AND SELECTIVITY
- AEROPLANE DIAL
- MANUAL ANTENNA CONTROL
- HIGH FIDELITY
- 5 NEW TUBES USED
- VERY EASY TO CONSTRUCT

Complete kit, including Dynamic speaker, power supply, coils from 14 to 200 meters, coil holder rack and complete instructions. Special Offer **\$14.95**

Black crackle finished metal cabinet \$2.50
Kit of matched ARCTURUS tubes 3.10
Broadcast coil, 200-550 Meters95
If you prefer it Custom Built, add. 2.50

Send 6c in stamps for descriptive circular
Order From This Ad Now While We Can Guarantee These Low Prices!

WORLD TROTTER RADIO LABS.
168 Washington St., Division R1, New York, N. Y.



Brings You the Next 4 Issues of "RADIO"—Subscribe Now

RADIO FOR JANUARY



Osockme, Japan, November 23rd, 1935.
 Etseemish Editor of RADIO,
 Dear Sir:

Happy New Year are soon come again, and with it come more ballyhoos and resolutions which are make to become broken into pieces and bits. Scratchi have resolved to make resolution which cannot be broken, by making no resolution at all.

So instead I are ready to make announcement of public services which I are to perform in 1935 for benefits of easy going radio amateurs. I are organizing The Scratchi Foundation. It are built on solid rocks, and it are for the purpose of replacing the now defunct Society For The Protection of Cruelty To Radio Amateurs. From such Foundation great goods will come forth and fifth, etc.

Scratchi wish first to make it become known that he have great secret. When he are told great secret he never make divulge of such secret except to two partis, Republican and Democratic parties. Secret of Scratchi Foundation are for make protection of all sacred amateur rights. Scratchi are having difficulty in finding right man to become President of Foundation. He must be man with credentials which he can show at Cairo Conference. Good credentials for such man to have would be, methink, two large bulky fists. When he are asked by Conference to show his credentials, he can pound them heavily on table.

One applicant make apply for President's job of Scratchi Foundation. I ask him what are he qualified for and what do he do to make protection for amateur rights? He snort back at Scratchi and say—"Humph, Amateur Rights! You make mistake, Hon. Scratchi. There are no such thing as amateur rights. They are now known as Amateur Lefts! They used to be rights . . . but now they are what is left of them, and amateur always take what are left, so why call them rights when they are Lefts?"

So Scratchi scratch his head and see lights through it. The man was right. The hams got left. There are no ham rights. We took what they left us. So what we got now is Lefts, not Rights! Thereupon Scratchi organize new Left Flank Brigade to march to Cairo to bring back Amateur Rights.

All good amateurs with big hearts and soles are become requested by Scratchi to send contributions to my home in Osockme, Japan, so that great Camel caravan can be purchased for march to Cairo. Such desert race horses will carry large amateur delegation to Conference and will make imposing spectacle on amateur frequency grabbers who will also pop up at Conference with evil thoughts in mind.

Such are purpose of the new Schatchi Foundation, conceived, inspired, devised and made into great functioning institution by Hashafisti Scratchi himself. All in favor say Aye. Others please remain silent.

Well, Hon. Editor, by time you receive this letter, it will seem like Christmas are over and completed. I have prepare my Christmas list. My wife ask me what kind new quartz crystals I would like best from her for Christmas gifts. There are such many new kinds of cuts now available for crystals that choice seem to lie between nineteen different kinds. There are A-T Cut, Cross-Cut, and Old-English Curve Cut. One type which appeal to me especially over and above all rest are famous 40% Cut which my gyp friend in New York radio store advertise in Japanese newspapers last week.

I have already receive much holiday mail, which all smell of true spirits of Christmas. Each have statement or bill attached. I find one letter from you, Hon. Editor, amongst all such mail and I open it with gleeful smile. I think it are check from you for many fine letters which I have writ for you in year just pass but I find you write exactly same kinds of letters as other news gypers. In your letter you say that you have receive all my contributions and that if I send you \$3.00 cash by return fast mail I will have privilege of reading my own letters in your magazine for another full year.

I wish for you Hon. Ed. to extend best 1935 wishes from Scratchi to all my followers in great United Shakes of America. To make especially sure that you get greeting card from H. Q. I are sending one for you to Hon Postmaster of Hartford, with request that he make forward to you. Hoping you remain unchanged in 1935, and not short-changed, I remain

Your devoured servant,
 HASHAFISTI SCRATCHI.

THE RADIO SHACK

OFFERS IMMEDIATE SHIPMENT ON RECEIPT OF ORDER
 HIGH VOLTAGE TRANSMITTING

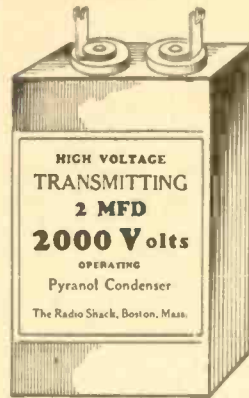

PYRANOL CONDENSERS

2000 VOLTS **\$2.50**
 2 MFD.

These Pyranol condensers are without doubt the finest filter condensers ever offered to the amateurs. The price is LOW and we warn you that when these are gone you will pay MORE, so buy yours now, and forget filter troubles forever. Many of the boys are using them on voltages up to three thousand and better. Believe us they are good.

Size 3"x4 1/2"x1"			
866 tubes, Heavy Duty.....	\$1.69	RCA S.B. Hand Mike.....	\$1.50
Triad 210.....	1.25	Baldwin Type C Phones.....	2.50
Triad 841.....	2.50	V. T. 203 A (Graphite).....	9.00

COMPLETE LINE OF PARTS FOR THE AMATEUR

Mail orders filled by return mail include postage—Send M. O. or check.

THE RADIO SHACK 46 BRATTLE STREET
 BOSTON

The Answer to HI-VOLTAGE RECTIFICATION... MULTI-ARC

Features . . .

- Conservatively rated at 10 amps. current. Inverse peak 15,000 volts . . .
- Air-cooled—no oil tank!
- Self starting—no rocking!
- A.C. keep alive — no Tungar
- Bulbs!
- Instant starting—no warming up!
- No filament — no deterioration!
- Life limited only by breakage!
- Simple, sturdy, fixed mounting!
- Efficient — voltage drop approx. 15 volts—keep alive consumption approx. 100 watts.
- Pyrex Glass throughout!



The most rugged and long lived rectifier available—highly economical for either medium or hi-power use.

PRICES

Type 2C, full wave.....	\$17.50
Type 4B, double full wave	22.50
Type 6P, six phase.....	30.00

Guaranteed for One Year
 Against Everything but
 Breakage

Over All Height—10"

MULTI-ARC LABORATORIES

2420 WEBSTER STREET

OAKLAND, CALIFORNIA

Latest In "B" Power



Smallest unit on the market. 2 1/4" wide, 4" high by 5" long. This complete Genemotor furnishes up to 200 volts D.C. Operates from 6 volt storage battery. Ideal for Auto, Airplane or Battery Radios, and Portable Amplifiers.

Write for details and prices on this and other types.

CARTER MOTOR CO.

365 W. Superior St.

Chicago, Ill.

GREATER DX



MORE FUN
 from your set with this new sensational **TRIMM Headset.**

Extremely Light—Automatic Volume Control—High Attenuation of Background Noises—24,000 Ohms Impedance—Finest Quality.

Every "HAM" has been waiting for a Featherweight Headset with all these features. Get yours today and get those distant stations more clearly and easily. There is a difference.

TRIMM RADIO MFG. CO.

1528 Armitage Ave.

Chicago

Radio Dealers and Jobbers who desire to advertise in these columns are invited to write for rates.

RADIO BUYERS' GUIDE

A Monthly Listing of Reliable Radio Dealers and Jobbers who solicit the patronage of our readers. Buy from your nearest Dealer or Distributor. He is dependable and reliable.

CHICAGO, ILLINOIS

Chicago Radio Apparatus Company, Inc.

415 South Dearborn Street
Harrison 2276

Dependable Radio Equipment
Established 1921

Bulletins on request—we specialize in short wave transmitting and receiving apparatus.
Catalog Ten cents.

CHICAGO, ILLINOIS

MID-WEST RADIO MART

520 South State Street
CHICAGO

Write for Special Catalog—Free

CHICAGO, ILLINOIS

Newark Electric Company

226 W. Madison St.
Chicago

All Kinds of Equipment for
Service Men - Amateurs - Experimenters
Write for free catalog

OAKLAND, CALIFORNIA RADIO SUPPLY CO.

2085 BROADWAY.

Hammarlund, Yaxley, Carter, National, Johnson, IRC, Cardwell, Miller, Morrill, Flechteim, Triplett, Haigis Transceivers
W6GFY

ST. PAUL, MINNESOTA

LEW BONN COMPANY

2484 University Avenue

Rex L. Munger, W9LIP, Sales Engineer

Radio Wholesaler

Complete Stock

BUFFALO, N. Y.

DYMAC RADIO

216 E. Genesee St.

CL 2080

Complete Stock Amateur Parts
STANDARD DISCOUNTS

—W8AWK—

LOS ANGELES, CALIFORNIA

RADIO SUPPLY CO.

912 SO. BROADWAY

The Amateurs'
HEADQUARTERS of the WEST

All Nationally Advertised Parts for
Receiving and Transmitting carried
in stock at all times.

9 Licensed Amateurs on Our Staff



NEW PRODUCTS

2 1/2 and Five-Meter Doublet Antenna

The new American Radio Hardware Co. 2 1/2 and 5-meter Doublet Antenna is a good solution to the antenna problems encountered in ultra-high frequency transmission and reception. It has always been the desire of the amateur to obtain the maxi-

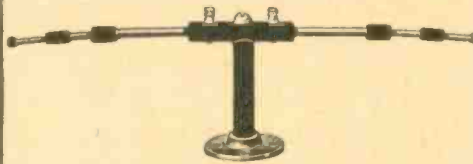

mum efficiency from each piece of equipment used. Tests conducted within the last few months prove that successful high frequency transmission depends to a great extent on the type of antenna system employed. In most cases, 5 meter antennas were made by the cut and try method and it took hours to "tailor" the antenna for the particular transmitter or receiver. With this new antenna with its special force type locking devices, it is a simple matter to obtain the proper length and this is important—maintain these adjustments for long periods of time.



The New G.E. Pyranol Transmitting Condensers

Inadvertently, the new G.E. Transmitting Condenser cuts were used in this column of the December issue of "RADIO" to describe a group of transmitting condensers manufactured by The Aerovox Corporation. The publishers hasten to correct this error. Here is a description of the new G.E. product, illustrated in the cut below:

General Electric D-C, Transmitter Capacitors are filled and treated with Pyranol, a nonflammable, non explosive dielectric developed and patented by General Electric. Pyranol has extraordinary insulating and dielectric qualities, and its use makes possible an unusually small and compact unit for all transmitter capacitor ratings. Compare the size with a capacitor of conventional design.

The lacquer-finished cases are hermetically sealed, assuring permanence of the characteristics of the capacitors, as contamination from air and moisture is impossible. Long life and ability to withstand temperatures as high as 75 deg. C. make these capacitors outstanding in their field. Porcelain bushings and mounting feet are included as standard equipment, and the units can be mounted in any position. They are suitable for continuous operation at voltages up to 10 per cent above the rated values.



The New General Electric
Pyranol Transmitting Condensers

CHICAGO, ILLINOIS

Chicago Radio Apparatus Company, Inc.

415 South Dearborn Street
Harrison 2276

Dependable Radio Equipment
Established 1921

Bulletins on request—we specialize in short wave transmitting and receiving apparatus.
Catalog Ten cents.

BUTLER, MISSOURI

HENRY RADIO SHOP

Complete stock of Collins, Patterson, National, Hammarlund, Silver, Cornell-Dubilier, Thordarson, Sylvania, Taylor, Cardwell, Triplett, Bliley, Trimm, Johnson, Turner, and others at lowest wholesale prices. Your used apparatus accepted in trade, too. Write for any information.
211-215 N. MAIN

FRESNO, CALIFORNIA

PORTS MANUFACTURING CO.

3265 E. Belmont Ave. Radio W6AVV
National FB7-SW3 and Parts; Hammarlund, Cardwell, Bliley Crystals; Johnson Insulators.
Distributors RCA-DeForest Transmitting Tubes
Established 1914 Send for Wholesale Catalog

SAN FRANCISCO, CALIFORNIA



1452 Market Street.

"The House of a Million Radio Parts"
Hammarlund and National sets and parts.
Sylvania Amateur Transmitting Tubes
Collins Transmitters.
Arcturus Receiving Tubes.
Trimm Phones, all types.
Johnson Antenna Feeders, Insulators,
Transposition Blocks.

SEATTLE, WASHINGTON



LARGEST PARTS SUPPLY DEPOT
IN THE NORTHWEST

Four of Our Employees Are Licensed
W7BR5 Amateurs W7CR
W7AVC W7WE

CORNELL DUBILIER, BILEY, PATTERSON
SETS, COLLINS, WARD, LEONARD,
UNITED TRANS.

SCHENECTADY, NEW YORK

Eastern Radio Supply Company

712 Broadway

Wholesale Distributors of
Tubes, Parts, and Test Equipment for
Service Men - Amateurs - Experimenters
Write for Quotations

Just imagine—there's where it comes from

Europe comes in like a local station

... and what **SALES VALUE** there is in these **QUALITY-AT-LOWEST-PRICE** Radio Receivers that represent the **LAST WORD** in **Round-the-World** reception!

A model in this group for every purse—American-Foreign and All Wave Radio Receivers

The public is now enthusiastic about radio receivers that will bring in foreign reception. This idea of having world-wide reception is going far to open wide the radio market. For no matter how fine a last year's radio may be—if it does not bring in the foreign stations, the owner is perhaps this moment considering a new radio that will. Certainly he has good

reason for listening when you talk to him about a second set for the home!

The market is there . . . growing every day. Crosley has given you the models to fit every need and every purse. Crosley has given you the program, the goods, and the price. You are losing money if you delay getting in touch with your Crosley distributor.



Sixty-One A. F.
Eight-tube effectiveness, airplane type dial, automatic volume control, 3-gang tuning condenser, distinctive cabinet.

\$39.95



614EH 3-Band All Wave
Two double purpose tubes provide 8-tube effectiveness. Many distinctive features. Outstanding quality of tone and performance. Low in price.

\$49.95



Seventy-Two A.F.
Airplane type dial, automatic volume control, continuous tone control, 10-tube effectiveness.

\$59.95

714GA 3-Band All Wave
Same cabinet as to left. 3-Band receiver for American-Foreign, police, amateur, aviation reception.

\$65.00



814FA All Wave
Illuminated airplane type dial, dual ratio tuning control, automatic volume control, push-pull output, continuous tone control. Gorgeous cabinet.

\$79.50

Sixty-Four MD (Lowboy)
Uses same chassis as Sixty-One A.F. Covers standard broadcasts from 550 to 1700 Kc. and Foreign broadcasts 5,800 to 15,300 Kc. Many distinctive features.

\$54.50



614PG 3-Band All Wave (Lowboy)
Uses same chassis as 614 EH. Covers standard broadcasts from 540 to 1650 Kc., police, amateur, aviation 1650 to 5000 Kc., Foreign 5800 to 15,300 Kc.

\$65.00



Seventy-Two A.F. (Lowboy)
A 7-tube American-Foreign receiver. Uses same chassis as Seventy-Two A.F. Covers standard broadcasts from 540 to 1700 Kc. and Foreign broadcasts 5800 to 15,300 Kc. Exquisite cabinet.

\$79.50

714NA 3-Band All Wave (Lowboy)
An all wave, seven tube, 3-band receiver in the cabinet shown at right. Uses same chassis as 714 GA.

\$85.00



814QB All Wave (Lowboy)
An all wave receiver, 530 to 24,000 Kc. Houses same chassis as 814FA. A superbly beautiful cabinet. The ultimate in all wave reception. Attractive in price.

\$99.50



All prices subject to change without notice.

Montana, Wyoming, Colorado, New Mexico and west, prices slightly higher.

THE CROSLLEY RADIO CORPORATION

Home of "the Nation's Station"—WLW—500,000 watts—most powerful in the world—70 on your dial.

POWEL CROSLLEY, Jr., President

CINCINNATI

WHATEVER HAPPENS . . . YOU'RE THERE WITH A CROSLLEY

CROSLLEY RADIO



AND NOW THE NEWEST 1935 DEVELOPMENT FROM
THE UTC ENGINEERING LABORATORIES

THE VARITONE* AUDIO TRANSFORMER

A universal audio input transformer giving continuously variable low end, high end, or low and high end equalization.



VT-1—Designed to work from a single plate or low impedance broadcast microphone line to one or two grids.

List price \$8.50—net to dealers \$5.20

Affords 15 DB controllable correction of low frequency response, high frequency response, or simultaneous correction of low and high frequency response.

The VARITONE is an essential component for high fidelity theatre and PA amplifiers. Manufacturers of such equipment are invited to write us regarding the application of the VARITONE to their equipment.

*PATENT APPLIED FOR

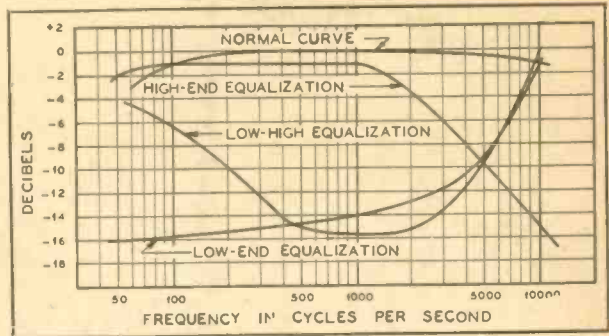

Typical Components for Use in a Popular Priced High Fidelity Receiver Amplifier Using the VARITONE as an Input Source.

	List Price	Net Price
PA-233 From two triode plates to 45 A prime grids	\$ 6.00	\$ 3.60
PA-245 From two A prime 45 plates to Broadcast and Voice coil lines	7.00	4.20
PA- 22 45 A prime plate and filament supply transformer	10.00	6.00
PA- 40 A prime input choke	4.50	2.70
PA- 44 Output smoothing choke	4.50	2.70
	\$32.00	\$19.20

What This
Universal
Modulation
Choke
Will Do:



It is tapped so that it can be used as an autotransformer coupler from Class B to Class C stages; various impedance taps are available so that each choke will readily accommodate push pull Class A-Prime or Class B Modulators, single ended Class A Modulator with the DC adding, or single ended Class A Modulator with the DC bucking.

The chokes are huskily constructed and air gaps are arranged to take care of the maximum DC currents.

Broadcast and phone men who want an output audio unit that will match all possible tube impedance combinations to the RF Stage cannot afford to be without the new UTC Universal Modulation Output Chokes.

TYPE		LIST PRICE	NET TO HAMS
HUC-20	Will handle 20 watts audio power. Can be used with class B 46's, 59's, 53, 6A6, 79, etc., or class A 2A3's, class A prime 42's, 45's, etc.	\$7.00	\$4.20
HUC-50	Will handle 50 watts audio power. Suitable for use with class B 210's, 801's, 830's, 841's, push pull parallel 46's or 59's, push pull parallel 45's A prime, push pull parallel 2A3's.	\$12.50	\$7.50
HUC-100	Will handle 100 watts audio power. Suitable for use with class B 800's, 211E's, A prime 284's, 845's, etc.	\$20.00	\$12.00
HUC-200	Will handle 200 watts audio power. Suitable for use with class B 203's, 830B's, HK-354's, single EIMAC 150T, push pull parallel 845's, prime, etc.	\$32.50	\$19.50
HUC-500	Will handle 500 watts audio power. Suitable for use with class B 204's, HK354's, EIMAC 150T's, A prime 212D's, A prime 849's, etc.	\$80.00	\$48.00

Complete circuit matching dots furnished with each unit.

UNITED TRANSFORMER CORP.

264-266 CANAL STREET

Export Division, 15 Laight St., New York, N. Y.

NEW YORK, N. Y.

Exclusive UTC distributors carrying a complete stock of UTC products.

Goldamer's, Inc.	610 Huron Road, Cleveland, Ohio	Cameradio Company	603 Grant Street, Pittsburgh, Pa.
Wholesale Radio Service Co., Inc.	100 Sixth Ave., New York, N. Y.	W. H. Edwards & Co.	32 Bway, Providence, R. I.
Wholesale Radio Service Co., Inc.	219 Central Ave., Newark, N. J.	SEATTLE, WASH.—Seattle Radio Supply Inc.	2319 Second Ave.
Wholesale Radio Service, Inc.	430 W. Peachtree St. N. W., Atlanta, Ga.	Portland Radio Supply Co.	1300 W. Burnside, Portland, Ore.
Sun Radio	227 Fulton Street, New York, N. Y.	Spokane Radio Co., Inc.	611 First Ave., Spokane, Wash.
Gross Radio, Inc.	51 Vesey Street, New York City	San Francisco Radio Exchange	1284 Market St., San Francisco, Calif.
Leeds	45 Vesey Street, New York City		
William Gram	1444 Sheridan St., Lansing, Mich.	SOUTHERN CALIFORNIA	
Mohawk Electric Co.	1335 State St., Schenectady, N. Y.	Pacific Radio Exchange Inc.	729 S. Main St., Los Angeles
Walter Ashe	1100 Pine St., St. Louis, Mo.	Radio Supply Co.	912-14 S. Broadway, Los Angeles
Radio Shack	46 Brattle St., Boston, Mass.	Coast Electric Co.	744 G. St., San Diego
Nutter & Cross	990 Milk St., Boston, Mass.	Prest & Dean Radio Co.	400 American Avenue, Long Beach
Radio Service Lab. of N. H.	1008 Elm St., Manchester, New Hampshire	Radio Television Supply Co.	1701 S. Grand Ave., Los Angeles, Calif.
Hatry & Young	203 Ann St., Hartford, Conn.	Radio Specialties Co.	1816 West 8th St., Los Angeles, Calif.

OHM'S LAW

$$E = I \times R$$

$$R = \frac{E}{I}$$

$$I = \frac{E}{R}$$

CONDENSERS IN SERIES

$$C_{TOTAL} = \frac{C_1 \times C_2}{C_1 + C_2}$$

RESISTANCES IN PARALLEL

$$R_{TOTAL} = \frac{R_1 \times R_2}{R_1 + R_2}$$

25c [^{30c} in Canada]

MARCH, 1935

\$3.00
PER YEAR
BY SUBSCRIPTION

RADIO

ESTABLISHED 1917

SHORT-WAVE AND EXPERIMENTAL

BOTTOM VIEWS OF SOCKETS

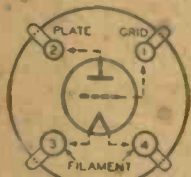

4-PRONG SOCKET
50-201-A, 45, 210, 30, 31, ETC.

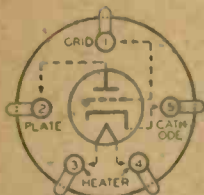

5-PRONG SOCKET
56-46-47-76-27-37

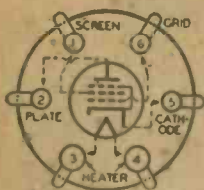

6-PRONG SOCKET
2A5-41-42-43



6-GRID-METAL TOP CAP
6-PRONG SOCKET
57-58-606-606-77478

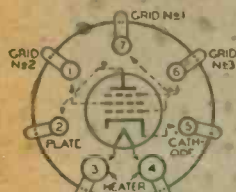

7-PRONG SOCKET 59



7-GRID N°4-METAL TOP CAP
7-PRONG SOCKET
2A7-6A7

- IN THIS ISSUE -

- ★ Controlled Carrier Modulation
- A Novel New 5-Meter Transceiver
- The "222" Receiver With R. F. Stage
- A Better Phone for the 160-Meter Band
- A Simple Vacuum Tube Voltmeter
- A New 4-Tube, 5-Meter Superheterodyne
- Ham Hints - Amateur News - Calls Heard



The Illustration Shows Frank C. Jones' Latest One-Tube Transceiver. It Employs Some New Features and a Novel Circuit.

Complete Details in This Issue

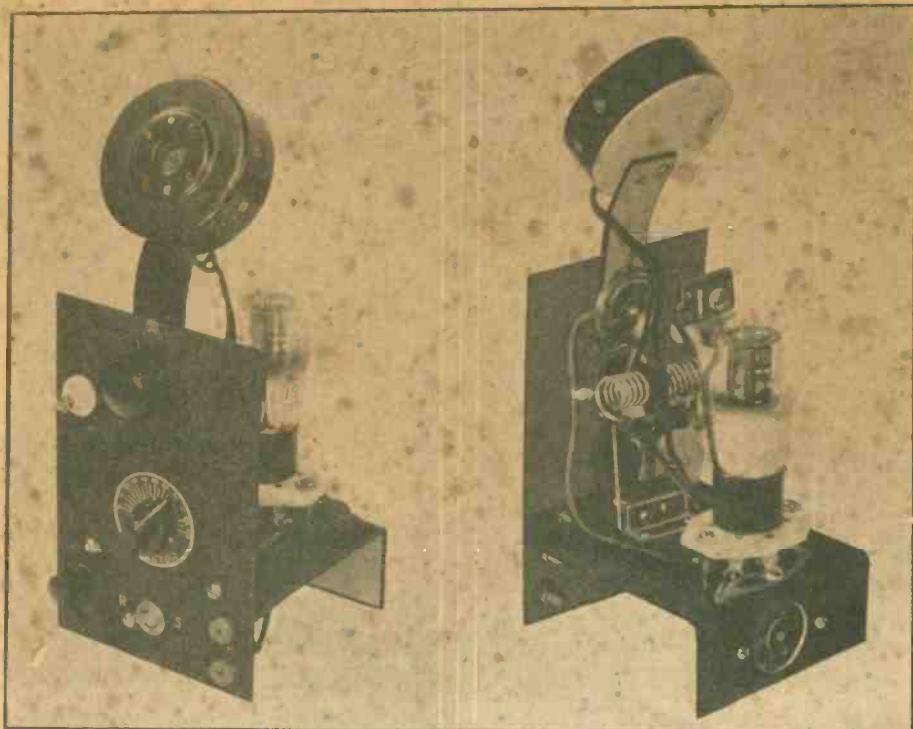

FEATURE ARTICLES BY ...

FRANK C. JONES
J. N. A. HAWKINS

FRANK LESTER
HENRY WILLIAMS

COL. C. FOSTER
I. A. MITCHELL

V E R S A T I L E

D E P E N D A B L E

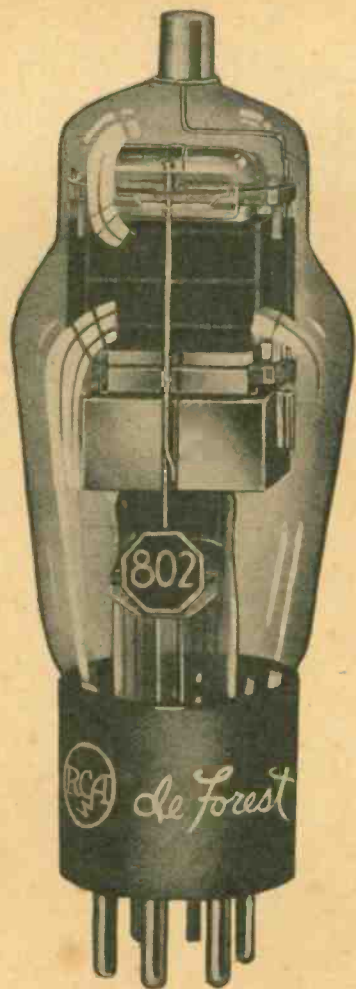

The NEW
RCA-802
AMATEUR'S NET PRICE
\$3.90

RCA Radiotron is proud to introduce this new RCA deForest type—the 802—which fills diversified needs for a moderate-powered pentode at a price within the reach of every amateur.

The applications of the RCA-802 are numerous. Some of the important uses which immediately suggest themselves are:

- (1) Straight pentode crystal oscillator,
- (2) Electron-stream-coupled oscillator,
- (3) Frequency multiplier (doubler, etc.),
- (4) Suppressor-modulated amplifier,
- (5) Control-grid-modulated amplifier,
- (6) Class C buffer-amplifier,
- (7) Class C power amplifier.

Employing a 6.3-volt heater, the RCA-802 also offers exceedingly attractive possibilities in a compact, low-powered 'phone transmitter for portable operation from an automobile storage battery.

Please send RCA-802 bulletin to:

Name _____

Address _____

City _____

Call Letters _____

Dept. O

Send us this coupon for complete technical information. Your RCA deForest Distributor has the RCA-802 in stock



**AMATEUR
RADIO SECTION**

RCA MANUFACTURING COMPANY, INC.
CAMDEN NEW JERSEY

NEW!



"IBT" MIDGET TRIMMER CONDENSER

New types of compact Hammarlund Condensers now available for trimming, padding, and transformer-tuning.

Some mount inside Coil Forms or Shields.

They are accurately rated, constant and reliable under the most severe conditions.

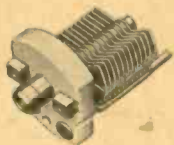

"APC" AIR PADDING CONDENSER

Variable I.F. COUPLING

provides SELECTIVITY or FIDELITY, as you choose

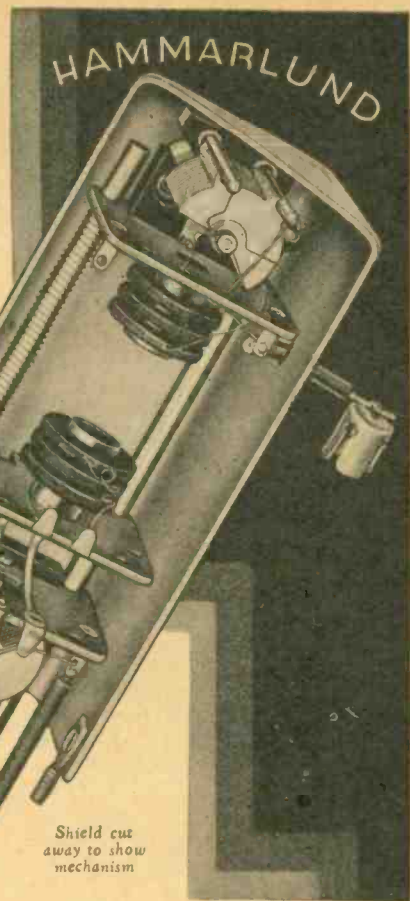
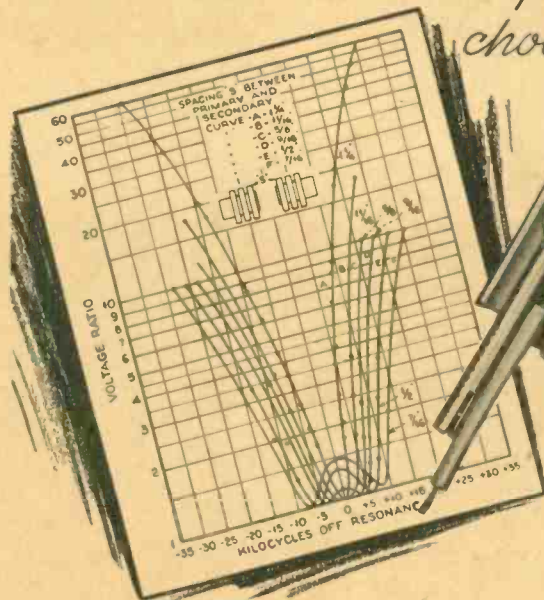

Shield cut away to show mechanism

NOW, the greatest single improvement in receiver flexibility in recent years. CONTINUOUSLY VARIABLE SELECTIVITY, from a needle-sharp peak to the flat top required for fidelity—without affecting tuning.

The transformer, basically, is the time-tested Hammarlund I.F.T. design, with new triple-type, pie-wound Litz coils and air-dielectric condensers. Plus the startling feature of continuously variable coupling between the coils.

Adjustment of coupling in each transformer may be fixed at any point, or continuously varied by panel-control, either individually or ganged in groups, according to selectivity desired.

The diagram shows the variable selectivity characteristics of a single transformer only. Designed primarily for use in the new COMET Super-"PRO" Receiver, soon to be announced, these transformers may easily be adapted to other superheterodynes.

Code No. VT.465 (465 kc.) List price, \$5.50 each, less 40% to experimenters.

New LOW-LOSS COIL SETS and COIL FORMS

Get more stations, louder signals and sharper tuning with these low-priced Hammarlund Coils (illustrated below). Users say they out-perform any other coils at any price. "XP-53", the new Hammarlund low-loss dielectric, has no artificial coloring to cause losses. The forms are ribbed for air-spacing, have easy-grip flanges and handy "Meter-Index"

inserts for coil ranges. Set of four coils for 15-270 meters (4 prongs, 2 windings), \$3.00. Set of four coils (6 prongs, 3 windings), \$3.75. Extra 4 or 6-prong coil for broadcast band, \$1.25 and \$1.50 respectively. Coil Forms (4 or 5 prongs), 35c each. 6-prong forms 40c each. 40% discount to experimenters.

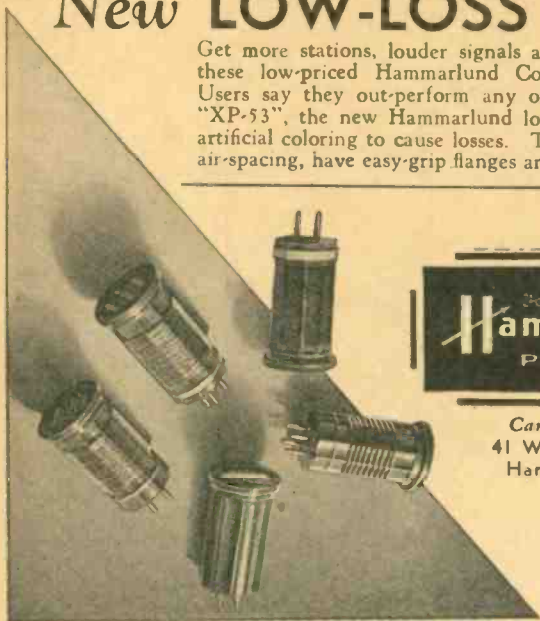

Canadian Office:
41 West Ave. North,
Hamilton, Ontario



Mail Coupon for New 1935 Catalog

HAMMARLUND MANUFACTURING CO.,
424-438 W. 33rd St., New York.

- Check here for details of new variable-coupling I.F. Transformer.
- Check here for FREE new 1935 General Catalog.
- Check here and attach 10c for 16-page Hammarlund 1935 Short-Wave Manual, illustrating and describing most popular S-W circuits of past year, with schematic and picture diagrams and parts lists.

Name.....
Address.....

PR-3

Dr. Lee de Forest

Father of Radio, whose genius has enriched human knowledge and enhanced human enjoyment of life and whose inventions still form the basis of vacuum tubes and oscillating circuits as we know them today

APPROVES AND USES IN HIS OWN EQUIPMENT AMPEREX CARBON ANODE TUBES

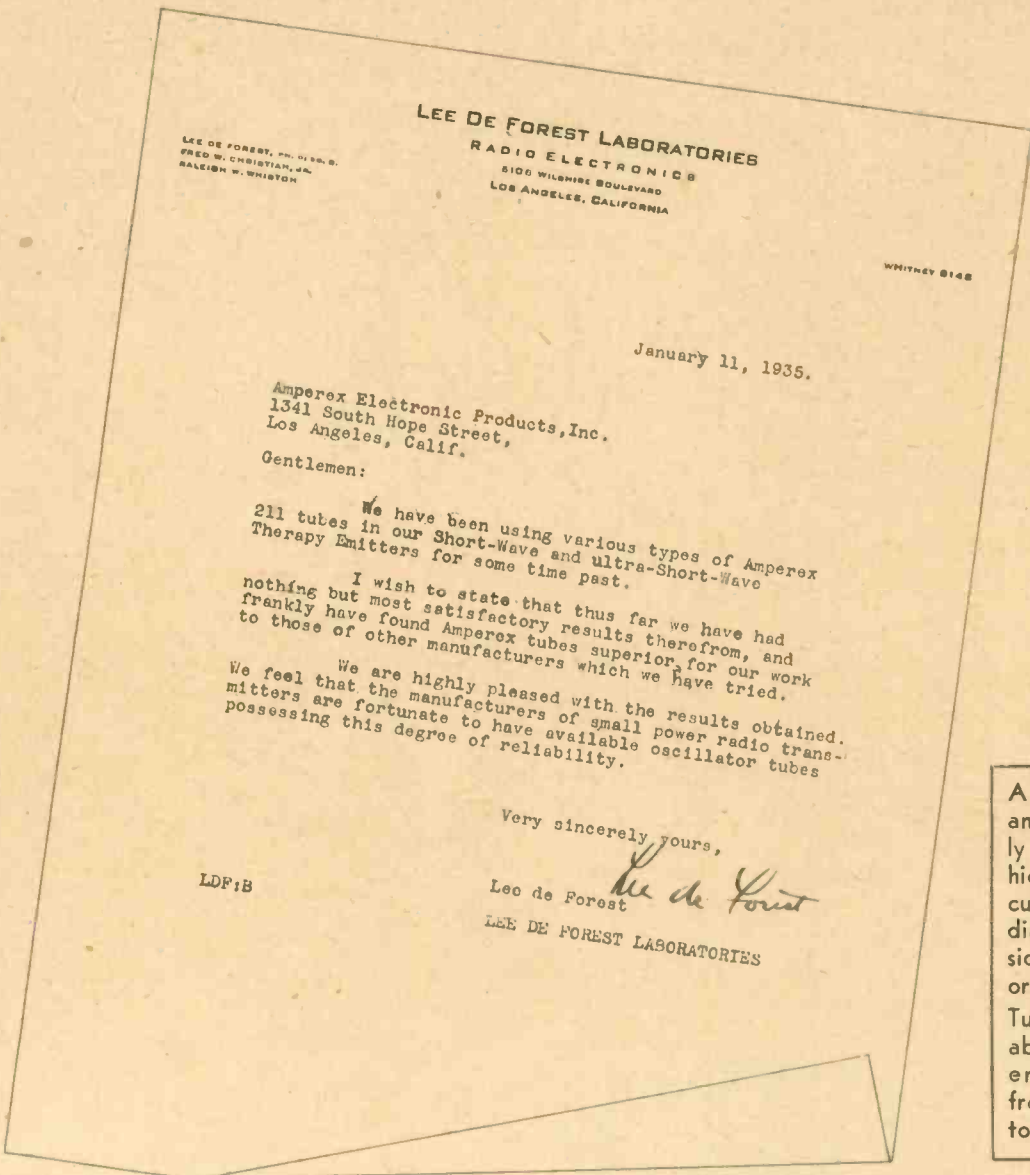

LEE DE FOREST, PH. D. PRES.
FRED W. CHRISTIAN, JR.
RALPH W. WHISTON

LEE DE FOREST LABORATORIES
RADIO ELECTRONICS
5105 WILSHIRE BOULEVARD
LOS ANGELES, CALIFORNIA

WHITNEY 8148

January 11, 1935.

Amperex Electronic Products, Inc.
1341 South Hope Street,
Los Angeles, Calif.

Gentlemen:

We have been using various types of Amperex
211 tubes in our Short-Wave and ultra-Short-Wave
Therapy Emitters for some time past.

I wish to state that thus far we have had
nothing but most satisfactory results therefrom, and
frankly have found Amperex tubes superior for our work
to those of other manufacturers which we have tried.

We are highly pleased with the results obtained.
We feel that the manufacturers of small power radio trans-
mitters are fortunate to have available oscillator tubes
possessing this degree of reliability.

Very sincerely yours,

Lee de Forest

Lee de Forest
LEE DE FOREST LABORATORIES

LDF:B

A full line of carbon anode tubes specially suitable for the high frequency circuits employed in diathermy and physio-therapy oscillators. Tube types are available which will operate efficiently at frequency ranges up to 100 megacycles.

AMPEREX ELECTRONIC PRODUCTS, Inc.

79 WASHINGTON STREET

RADIO TELEVISION SUPPLY CO.
RADIO SPECIALTIES CO.
SAN FRANCISCO RADIO EXCHANGE
ZACK RADIO SUPPLY CO.
ELECTRIC SUPPLY CO.

LOS ANGELES
LOS ANGELES
SAN FRANCISCO
SAN FRANCISCO
OAKLAND

Distributed by

E. C. WENGER CO.
B. J. De JARNATT
HENDERSON BROS.
COAST ELEC. CO.

BROOKLYN, N. Y.

OAKLAND
FRESNO
SACRAMENTO
SAN DIEGO

BRANCH OFFICES:
New York City,
253 W. 128th St.
Tel. MOument 2-2812
Boston,
J. H. Condon,
6 Marlboro St.
Chicago,
C. W. Nelson,
3618 North Bernard St.
Los Angeles, Calif.
1455 Glenville Drive.
Tel. CRestview 4017

RADIO

ESTABLISHED 1917

Reg. U.S. Pat. Off.

A NATIONAL MAGAZINE - PUBLISHED MONTHLY

Publication Offices—Pacific Building, San Francisco, California

Clayton F. Bane, Editor
H. W. Dickow, Business Manager.
D. B. McGown, Technical Editor. Frank C. Jones, Ultra-Short-Wave-Engineering Editor.
Clair Foster, Amateur Activity Editor. George B. Hart, Contributing Editor.
C. C. Anderson, Engineering Draftsman

25c per copy, \$3.00 per year by subscription in the U.S. \$4.00 elsewhere. Send subscriptions to the San Francisco office. Entered as second class matter at the Post Office at San Francisco, California, under the Act of March 3rd, 1879.

Vol. 17

MARCH, 1935

No. 3

Radiotorial Comment

Shot in the Patio

● The whispering campaigners have a new rumor afoot. "Colonel Foster shot in the war," they say. And this latest attempt to discredit the writings of the Colonel is used as a means to prove him of unsound mind. So the editor of this magazine made a request of the Colonel for the facts of his war injury. The following letter came in reply:

A RELIABLE citizen of New York has forwarded the remarks made to him by an amateur who is a supporter of the present regime at ARRL headquarters.

"This fellow, Foster, during his military service suffered some kind of an injury. As a result he goes through a peculiar cycle; first he is a great friend of someone but as time passes he goes into a period in which he quarrels violently with the erstwhile friend for no reason except things of his own imagination. You know he gave the ARRL a motor-generator set which is still being used at WIMK. The man is really mentally unsound and is to be pitied. That is the reason Warner does not feel like showing him up."

The source of the tale is readily recognizable. Pres. Maxim in his last annual report to the ARRL directors referred to me as that unbalanced but influential leader. I have been plastered with Hartford labels for years, until I now look like an old suitcase that has been on several Cook's Tours. One of the choicest of the collection is one provided by Budlong, Warner's assistant. He wrote one of the fine oldtimers in the East, "Foster would like to see the Headquarters spit in the faces of the commercials", and the oldtimer sent the letter to me. Budlong's intention was to spread the impression that while the Headquarters men were living up to their much-advertised "high standard of conduct", Foster represents the depth of ill-breeding.

But, for all I know, there may be something in this claim that I am mentally unbalanced. The crazy man is the poorest judge in the world of his own mental state. The crazier he is the surer he is of his own sanity. So I would best leave mine to the decision of others—which may be, for all I know, merely an insanely adroit way of making people think I am sane. At any rate, perhaps I would better relate the story of my war injury. It may give the judges some slant of my present mental condition.

During the war a detail of us men of the Corps of Engineers was assigned to help the British repair a bridge the Germans had dynamited. The Germans came back and drove us off with rifle-fire. In beating it back to the British lines I turned my ankle and was utterly unable to walk. I dragged myself into a shell-hole. A sergeant threw

himself into the hole beside me and explained that I would have to get out of there—that the Germans would surely come this far and would finish me. I showed him my predicament, that I couldn't put my foot to the ground. He urged that I must get out somehow and that if I could get on his back he would carry me in. I put my arms around his neck and he legged it for the rear with me on his back. On the way in a bullet hit me in the posterior, but the sergeant made good time and we reached the British lines without further mishap.

Now, of course I don't know how much, if at all, a wound in that location may affect a man's mind. Some men carry the seat of their intelligence in the seat of their pants, but whether I myself am one of those men I have no means of knowing. But whether it affected my mind or not I know it affected profoundly my faith in the unselfishness of human nature. The sergeant some months later said the only reason why he had stopped to carry me in was that I was so big I would afford fine protection for him.

Anyway, I got a bullet in the patio and he got the Victoria Cross for it.

For years I have kept this story to myself. This is the first time I have ever told it, but it seems only fair to give the pitying Mr. Warner a break.

—Clair Foster, W6HM.

"RADIO" Backs the League

A DISTINGUISHED servant of the League, peering into the narrow neck of an empty whiskey flask used as a substitute for the mystic ball of a crystal-gazer, informed the publisher of this magazine that the League would put "RADIO" out of business unless our campaign of criticism is brought to a halt. Like the man who predicts the weather reports for the newspapers, we don't always get the kind of weather the papers like to give us. And so it was with the League prophet, when he forecast our early doom. For we were supposed to have been out of business at 2:15 A. M., three Saturdays ago. By some strange turn of fate we are still in business today. The score—one to nothing.

Unlike those who are trying so hard to subdue the growth of this magazine, "RADIO" has no desire to see the League go out of business. Quite the contrary. It is our sincere purpose to help strengthen the League structure; our campaign has not been directed at the League, as a League—it is aimed fairly and squarely at those who have taken it upon themselves to administer the affairs of the League as they see fit, not in accord with the wishes of a vast number of amateurs who are trying so hard to make the League a better organization to belong to.

All the constructive suggestions offered by this magazine have been poo-pooed by the square-jawed, two-fisted fighters at Hartford. For fighters they are—fighting to hold their jobs!

Now we are told that Congress can do nothing to protect the future of amateur radio. The suggestion to solicit Congressional aid came from this magazine; consequently, it CAN'T be worth a whoop. If the suggestion were good, the League would have appealed to Congress years ago, you have been told. It is a matter of record that the amateur has fewer privileges at this time than he ever had before. Why? Because we did NOT solicit the aid of Congress. Running true to form, the criticism comes from those who are being criticised for not doing what they are paid to do. You, as amateurs, pay for protection; why not make it your business to get it?

The commercial interests go to Congress and get what they want. They hire fat-salaried lobbyists. The amateur stays away from Congress and gets what the commercials feel like giving him. We ask one simple question—why does not the League spokesman join with us in this campaign to solicit Congressional aid? The answer seems quite obvious—the suggestion did not come from him!

The radio amateurs of Northern California recently met in San Francisco for the purpose of forming an alliance of radio clubs. A delegate from one of the clubs suggested the alliance be politics-free. Asked to define politics, he replied—"Trying to get more frequencies is non-political; asking that we fire Warner is political."

To this writer it seems the reverse is true. In order to get more frequencies the greatest political drive in all amateur radio history must be waged; that drive is well under way.

Up stood another amateur from Warner's pet thorn-in-the-side radio club, San Jose, California. Said he: "I have recently been in conference with a former member of Congress. He tells me that in his 16 years of public service no request, to his knowledge, has ever been made by Mr. Warner for Congressional aid."

Every sane amateur KNOWS we must appeal to Congress at one . . . not two years hence! The wheels of government turn slowly. We must first acquaint our Congressmen with the deplorable conditions prevalent in amateur radio. Further delay can prove disastrous. Stereotyped letters should not be sent to Congressmen. Write a simple, homely, sincere message to your Congressman. Tell him what we have today, what we had years ago; tell him how we lost what once was all our own. Ask for his cooperation in getting a little more breathing space in which to operate. The amateur is not unreasonable.

(Continued on page 33)



Mr. I. A. Mitchell is here shown in his laboratory where tests are being conducted with controlled carrier modulation.

Controlled Carrier Modulation

Voice-Actuated Sub-Audible Carrier Control for Increasing Power Output From a Given Tube Capacity in the Final Amplifier

Minimizes Cross-Talk for Duplex Operation. . . Saves Power . . . Reduces Heterodyne Interference . . . Requires No Special Modulator Tubes for High-Power Use

A Pair of 210 Tubes Gives the Same Signal at the Receiving End as Conventional Systems Using 50 Watters

★ Many experimenters have long tried to find a way to cut down the carrier input and output during periods of low modulation. Various methods have been proposed; none proved practical for amateur operation. Some systems called for the use of Thyratrons, or grid-control rectifiers; others used series modulation, with its attendant adjustment difficulties. The system here described by Mr. I. A. Mitchell is the first workable solution of this problem. It involves no important compromises.

● Controlled carrier modulation is to the RF end of a modern transmitter what class B is to the audio end. In addition to the advantages of increased power efficiency, extended tube life and the use of smaller tubes for high power output, controlled carrier modulation reduces interference between stations and increases effective working range of transmission. While all this may sound like the Utopia of a day-dreaming engineer, the data and explanations which follow will readily substantiate these facts to those who are interested in the theoretical side of transmitter design.

Controlled carrier modulation can be defined as a method of modulation in which

* Chief Engineer, United Transformer Corp.

By I. A. MITCHELL*

the average carrier output varies with the audio level, instead of remaining constant as in conventional modulation systems. Fig. 1 illustrates the relation of RF power to AF

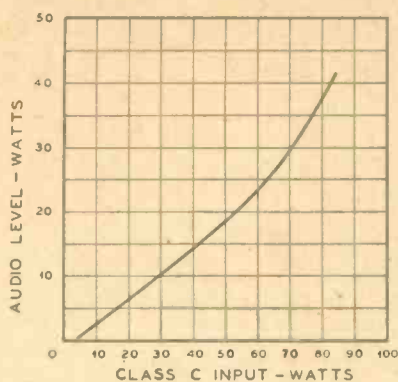

FIG. 1—Class C input vs. Audio level in a Controlled Carrier Transmitter.

power in a typical transmitter using the first really practical system of controlled carrier modulation. This experimental transmitter used four 59s in class B in the audio modulator and a pair of 801s with controlled class C input in the final. Before going into the technical details of this transmitter, let us examine more closely the various advantages of this controlled carrier modulation and the effects which produce these advantages. They can be enumerated as follows:

1. Reduction In Power Consumption and Operating Costs

Fig. 2 illustrates the relationship of power measured at the primary of the plate transformer for the final as compared to different audio levels. Every amateur who has watched the wiggling of the plate current meter in a class B amplifier, or by means of an oscilloscope used to check percentage modulation, realizes that speech and music are not of continuous level, but consist of a series of valleys and peaks representing different audio levels. Tests by the writer have indicated that if these valleys and peaks are integrated over a period of time, the average audio output is less than 20 per cent of the amplifier peak power handling ability. This is par-

ticularly true of the amateur phone station, because silent periods of short duration are extremely frequent. An approximate check taken on three stations indicated that the effective audio power was less than 10 per cent of maximum for 90 per cent of the time.

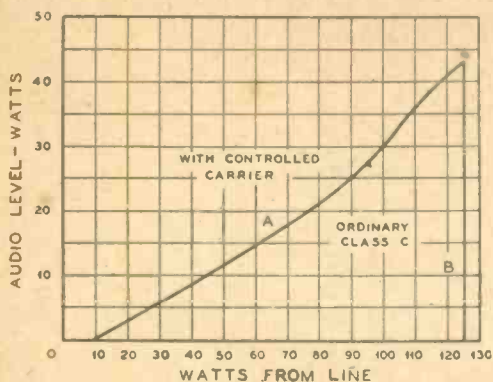

FIG. 2—Comparison Between Ordinary Class C and Controlled Carrier Class C as Referred to the Variation of Power Consumption from the Line vs. Audio Power.

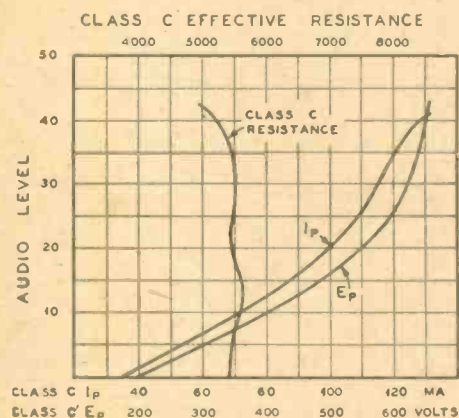

FIG. 3—Relation of Class C Operating Characteristics to Modulator Level in Controlled Carrier Transmitter.

Using this approximate check, the audio power taken 90 per cent of the time on the transmitter described above would be below 4½ watts. In an ordinary transmitter using 801s for the final, Curve B, Fig. 2 would indicate that a constant power of 125 watts would be taken from the line by the final plate transformer. Considering this with respect to Curve A, Fig. 2, this means that for 90 per cent of the time the power taken from the line will be reduced to less than 24 watts. Furthermore, for a very considerable portion of the time the power taken from the line by the final plates will be only 10 watts. This saving in power is tremendous. If duplex operation is used, the operating cost is reduced still further, as negligible plate power is taken by the final during receiving periods.

2. Increase in Tube Life

Referring again to Fig. 1, it is seen that at low audio levels the class C input is very low. This is shown still more clearly in Fig. 3. It is seen from this latter curve that at zero audio input the class C plate current is only 36 milliamperes total, and the corresponding plate voltage 195 volts. The increased tube life at this low plate power is obvious. Using the previous approximation of 10 per cent audio level for 90 per cent of the time, the class C input to this pair of 801s is found to be less than 15 per cent its maximum value for most of the time. The resultant reduction in plate dissipation should increase the tube life many times over. At the moment, the writer does not have

facilities to determine this increase and we must consequently wait for further data from the tube companies before an accurate measure of this replacement economy can be determined.

3. Use of Smaller Tubes For High Output

Most amateurs are familiar with the theory of class B amplification and realize why class B audio amplification made possible greater power from audio tubes. This is easily seen on the curve for plate current vs. power output of a class B system as in Fig. 4. Because the plate current swings through a wide range, the average effective plate current is much less than that at maximum output. An examination of Fig. 3 will show a striking similarity between the class C plate current vs. audio level and the class B plate current vs. audio level of Fig. 4. The effect of the curves is almost identical and consequently it is found that the available power output from a given pair of tubes used with controlled carrier modulation can be increased greatly over the output available from the same tubes in a normal class C amplifier. Tests conducted so far seem to indicate that an increase of almost 100 per cent can be obtained.

4. Reduction of QRM

Because the carrier magnitude is reduced for the greater part of the time, interference between stations is greatly reduced. This is of vital importance in broadcasting as the allocation of stations by the FCC is such that normal interference is comparatively small. The additional aid of reduction in carrier would eliminate this effect practically entirely. To the amateur this is of importance; using controlled carrier modulation the beat note between stations is reduced for a major part of the time and the consequent crowding of the ether which is present on the amateur bands today would be greatly reduced.

5. Increased Working Range

One of the first fundamentals in phone transmission is the formula which states that the carrier power required for a given field coverage varies inversely as the square of the

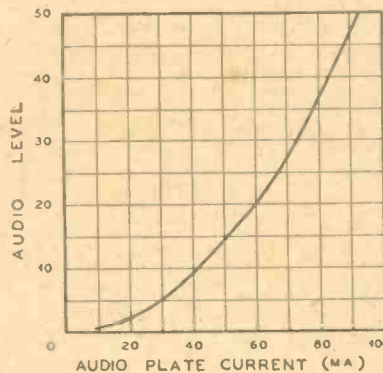

FIG. 4—Relation of Plate Current to Watts in a Typical Class B Amplifier.

modulation percentage. Assuming for ordinary speech a percentage modulation of 10 per cent for 90 per cent of the time, we find the following peculiar fact; since

$$\text{Power A} = \% B^2$$

$$\text{Power B} = \% A^2$$

and assuming 50% for "A" (controlled carrier) and 1.58% for "B" (regular class C): (See Fig. 8):

$$\frac{\text{Power A}}{\text{Power B}} = \frac{.25}{.00025} = 1000$$

This means that at 10 per cent audio level the same coverage (distance) could be obtained from a 10 watt transmitter using con-

trolled carrier as from a very much larger transmitter using normal class C. This does not apply to the maximum audio level; at which well-designed transmitters of both types should give 100 per-cent modulation. However, as previously stated, the average audio

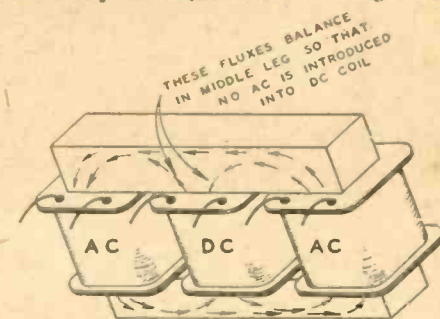

FIG. 5—Appearance of Saturable Reactor.

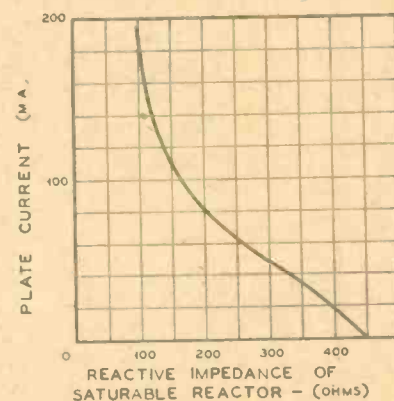

FIG. 6—This Curve Shows the Change in Reactance of AC Coils in a Saturable Reactor as the DC Is Increased.

power is far below the maximum audio power. Putting it another way, let us say that if Joe Ham whistled code into his phone transmitter so that 100 per-cent modulation was obtained on all signals, he might contact New Zealand. On the other hand, if he spoke into the microphone, New Zealand could hear only the loud notes of his voice and would miss the lower intensity notes at which the percentage modulation is appreciably lower and the consequent coverage very much smaller. In this respect it might be remembered that broadcast stations have found that the minimum audio power range for good fidelity must be at least 30 DB. This represents a minimum audio power equal to .1% maximum audio power which is a much greater change in percentage modulation in the ordinary transmitter than in any of the examples referred to above.

6. Increased Fidelity

Broadcast stations have found it necessary to increase the range of audio levels they transmit very appreciably to take care of modern high fidelity requirements. Massa of R.C.A. claims that a range of 70 Db. in audio level is required for real high fidelity. One of the greatest stumbling blocks in the progress of broadcasting in this respect has been the fact that due to the decrease in modulation percentage, the corresponding effective coverage is reduced in accordance with a square law. However, using controlled carrier modulation, the major part of this effect can be eliminated and a much greater range in audio level can be obtained with the same maximum power output and the same coverage. Another important factor in fidelity is the tendency prevalent among broadcast stations and amateurs to overmodulate. If controlled carrier modulation is used, when the audio level rises to the point

Colonel Foster's Comment

THE CONVENTION OF 1927

IT WAS at the Convention of 1927 that the amateurs of America first came under the sinister influence of the foreigners. After having voluntarily relinquished to the commercials all but some narrow bands the amateurs lost at this convention two-thirds of their space even in these narrow bands. They also had new international restrictions imposed. And yet K. B. Warner, manager of the organization that had assumed spokesmanship for the amateurs introduced his report of the convention with a glowing paragraph ending, (see QST for January 1928), "Those privileges in most respects are entirely adequate. We have achieved a great victory."

It was indeed a great victory for the commercial members of the ARRL. Warner knew the trimming the amateurs got was a disaster for the amateur members but it seems there were business reasons why we must be kidded into thinking it was a victory and that we must be stopped from appealing to Congress for a reservation in behalf of the amateurs. So the directors of the ARRL were individually beseeched to back up the astounding myth in the following disingenuous letter:

Hartford, Dec. 2, 1927.

ALL DIRECTORS:

Vice-President Stewart and I were in attendance at the International Radio Conference at Washington for the seven weeks of its duration. Upon my return, as the quickest and most effective way of conveying a report to the Directors of our activities there and the results obtained, I have had some advance copies struck off of an article and editorials prepared for January QST, and attach same. I feel that this will explain the subject matter more clearly and at much greater length than I could hope to in a letter.

The Executive Committee and the A. R. R. L. Headquarters staff are of the opinion that the facilities afforded by the provisions of the new convention are adequate for amateur operation. We have felt the necessity of expressing immediately, in broadcasts and in QST, the opinion that our results at Washington must be viewed as successful and that the privileges secured there are quite sufficient to insure the continued happy existence of amateur radio. Immediate expression of this viewpoint was deemed essential in view of the pessimism rapidly being disseminated through amateur ranks, the false reports that we had lost all territory between thirteen and fifty meters, the general loss of faith in the League and amateur radio that the public would display if it were felt that we had been beaten, and to offset any unfavorable action by QST advertisers based upon the fear that amateur radio was about to experience a tremendous setback. We do not share that view; we believe in fact that the restrictions which will become effective in 1929 will serve as a tremendous spur to a new and healthy amateur activity. We recognize, however, that official A. R. R. L. views on such matters are to be expressed only by the Board of Directors and that it cannot be said that the League accepts and embraces the results of this convention if the Board is of a contrary opinion.

In several quarters of the country unofficial and unauthorized broadcasts have

been started by zealous amateurs, calling upon all recipients to write immediately to their Senators and Congressmen to urge that the Senate make a reservation on behalf of wider bands for American amateurs when ratifying the treaty. We are doing what we can to suppress this movement at the present, as being futile and ill-advised. We are telling the amateurs concerned that any such action depends upon the decision of our Board of Directors which has not yet had time to examine the results. It is the opinion of your Executive Committee that it would prove highly embarrassing for us to attempt to secure a Senate reservation to increase the size of the American amateur bands. It may be possible to secure such a reservation, particularly with respect to an extension of the 40-meter band downward, but we believe that the radio people of the United States government would be highly opposed to such a move. If we care to risk their disapproval by seeking political support for a reservation it is possible that we can secure it. However, we feel that we will be able to operate well enough in the bands authorized by this convention, and in view of the disrepute into which the amateur would be brought, both nationally and internationally, by forcing or even attempting to force a reservation in the United States, the Executive Committee earnestly recommends that no such attempt be made.

It seems very desirable that Headquarters, for its government, receive an expression of opinion from each Director as to whether the League accepts the provisions of the Washington Convention, or whether it should commence now in an endeavor to secure a reservation to extend the 40-meter band downward and, if the latter, to what extent. The Executive Committee recommends to the Board that it approve the Convention and make no attempt to seek a reservation.

(Signed) K. B. WARNER,
Secretary.

It was Warner in QST and in correspondence, and headquarters representatives at amateur meetings, who continued to spread among both commercial people and amateurs the same perverted propaganda that the amateurs got all they needed at the Washington convention.

And it was President Maxim himself who advertised to the whole world, (see it in QST for August, 1929) that the amateurs had to be further restricted at the 1927 convention since the public interest required it. He said that restrictions were attendant upon progress and that it is of no avail to buck them—that the amateur cannot stop the progress of the world—that it would do the amateurs just as much good to buck restrictions as it did the red Indian to buck the coming of the white man. Surely a vicious philosophy, for if courageous and upright man had not bucked injustice throughout history the world would not now be a fit place in which to live.

These published statements of President Maxim, like those of its general manager, went far and wide. Maxim says of QST in his last annual report to the directors, "It passes across the desks of nearly every important figure in the radio world". He was well aware of this when he virtually put all of the commercial people and the radio men of foreign nations on notice that he, the presi-

dent of ARRL, was agreeable to the restrictions of the Washington convention and that he proposed to do no bucking over still further restrictions. After all the published avowals of men recognized as spokesmen for the amateurs just how much chance had the amateurs to regain at Madrid any of their lost rights and frequencies! And if the same men still speak for the amateurs when the next convention comes along just how much assurance have we amateurs that we shall have anything left at all!

So let nobody be deceived with the thought that the ARRL neglects the interests of its commercial members—regardless of whether such members vote or do not vote. Throwing the ARRL open to them back in 1920 was the amateurs' major disaster but the results of it need not obtain forever. The effects of every disaster can be overcome in some measure. The Congress of the United States is the one agency for setting aside the injustices of this one. It should be the duty and the purpose of every American amateur to carry the amateurs' case to the court of public opinion through his Senator and his representatives in Congress.

Clair Foster, W6HM.

LEST WE FORGET

THE ARRL was formed specifically as an association of transmitting amateurs. It remained just that until a year after K. B. Warner, its present manager, took charge under an employment contract that provided a salary of \$30 a week, plus 25 cents out of each yearly paid dues, plus 25% of the net profits of the magazine, "QST". That contract was a bad mistake of the directors. Paying a man commissions is all right in a commercial undertaking but is wholly out of place in a fraternal organization. It has been tried in other fraternal organizations and in every case has worked disastrously, for it puts such employees in the class of promoters and inevitably leads to their bending their efforts towards increasing their commissions.

Let us see how it worked in Warner's case. There were no net profits from QST at that time. There are not today, for that matter. It was unlikely that Warner would realize much if anything from QST, so he concentrated on increasing the membership of the ARRL. It is seen from a reading of the QSTs of that day that immediately a drive was started for new members. Month after month the drive proceeded, spread in print with all the characteristic appeal of the drive-promoter. The first year of Warner's employment his rake-off besides his salary was \$898, making his total compensation for the year \$2,458, which was big pay in those days for a young fellow with little previous business experience. It was far more, I'll venture to say, than he had ever made before. But there is no fault to be found with it if the accounting was correct; the payment was in accordance with the prospect held out to him by his contract.

However, the money was not coming in fast enough to suit Warner. So a new scheme was devised and put into operation. At that time, 1919, there were members of the ARRL and there were subscribers to QST who were not members. The scheme was simplicity itself—provided the directors did not see through it and object. It was to call all subscribers, whether amateurs or not, "mem-

(Continued on page 17)

The Single Tube 35-19 Transceiver

By FRANK C. JONES

● There is a demand for the simplest possible circuit which is suitable for phone transmitting and receiving on five meters. Simple circuits, such as this 1935 model of the original 19 tube transceiver described last year, are not as good as two or three tube sets. However, for the beginner, or for extreme portability, this new type 19 single tube set has its place.

The circuit has been so simplified that the number of parts in the set is a minimum. This makes it easy for the newcomer to the 5 meter band to get on the air on phone. The type 19 tube acts as a modulated oscillator for transmitting and as a super-regenerative detector and audio amplifier for receiving. The change from transmit to receive is accomplished by means of a single-pole, or On-and-Off snap switch.

The set acts as a transmitter when the switch is on the closed ("on") position, performing the following functions: (1) The tuned circuit causes 5 meter oscillations in one of the triode units of the 19 tube. (2) The oscillations are radiated either by an 8 ft. antenna connected directly to the antenna post, or by means of a one or two wire matched impedance RF feeder line. (3) The tuned circuit is capacitively coupled to the antenna by means of a trimmer condenser coupling capacity. Normally the adjusting screw is taken out in order to obtain lower capacity. This capacity may be varied by bending the movable plate.

Modulation is obtained by the old familiar method of loop modulation. The microphone is connected in series with 3 or 4 turns of wire, coupled to the oscillator coil. When the mike is spoken into, its resistance varies and the current through it and the loop pick-up coil varies, thus giving modulation. The system is an absorption method and consequently the output usually drops when the mike is spoken into. However, by proper adjustment of the loop coil coupling, a fair amount of understandable modulation is obtained. This coupling is critical and should be as close as is possible to use and still maintain super-regeneration while receiving. More satisfactory modulation is obtained this way than in the grid modulation method used in last year's circuit. The mike should preferably be mounted on the transceiver in order to keep the leads short.

The 19 tube is a good oscillator and the carrier is greater than can be obtained from a type 30 tube. The oscillator circuit shown has proved to be much more efficient than the unity coupled circuit shown in last year's set. Super-regeneration can be obtained with somewhat less than 80 volts with this cir-

cuit, while the one of last year required at least 135 and often 180 volts of B battery. Super-regeneration gives a high degree of sensitivity for 5 meter reception and is used exclusively in the more simple 5 meter receiving circuits. This set will function with only 90 volts of B battery, but the power

output is only about half that obtained with 135 volts. The antenna coupling can be greater with the latter value of voltage without pulling the detector out of super-regeneration, denoted by a loud hiss when not receiving a signal.

The second triode unit of the 19 tube is used as an audio amplifier when receiving. The oscillator section merely super-regenerates and only the grid circuit rectified signal is used across the grid of the other

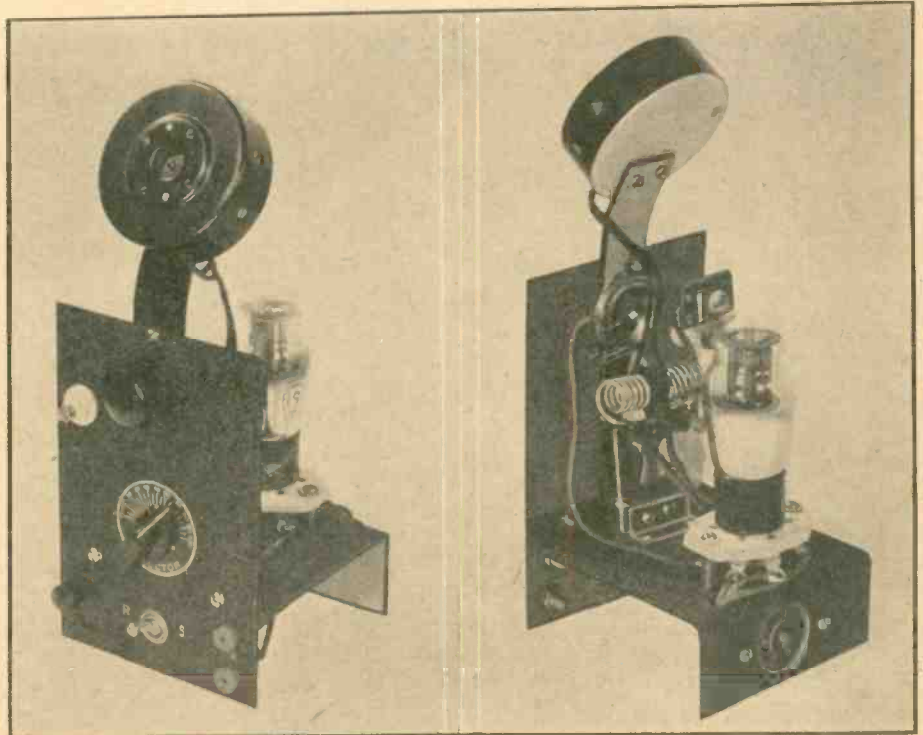

Front and Rear Views of the ultra-compact 35-19 Transceiver. The microphone is secured directly to the front panel. A mouthpiece can be attached to the mike. A toggle switch is used to change from send to receive. The rear view illustration does not show very clearly how the mik coupling loop is placed between the two coils, L1 and L2 (see circuit diagram). This mike loop coil is merely suspended between the two coils; it is made of insulated push-back wire, the loop is self-supporting and its coupling is easily varied. The RF choke is barely visible in the photo. It is supported on the bakelite support piece which holds the tuning condenser.

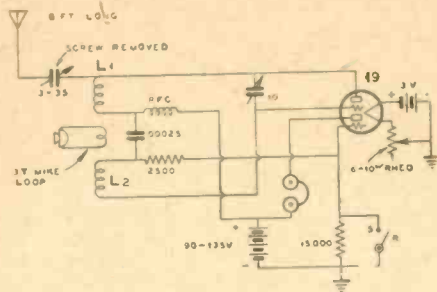

CIRCUIT DIAGRAM OF THE 35-19 TRANSCEIVER
Coils L1 and L2 each have 6 turns of No. 12 or No. 14 bare copper wire, 1/2-in. diameter, 3/4-in. long. The Mike Loop Coil has 3 turns of insulated push-back wire, 1/2-in. diameter, placed between coils L1 and L2. The RF Choke Coil has 50 turns of No. 22 DSC wire, 3/6-in. diameter, air supported.

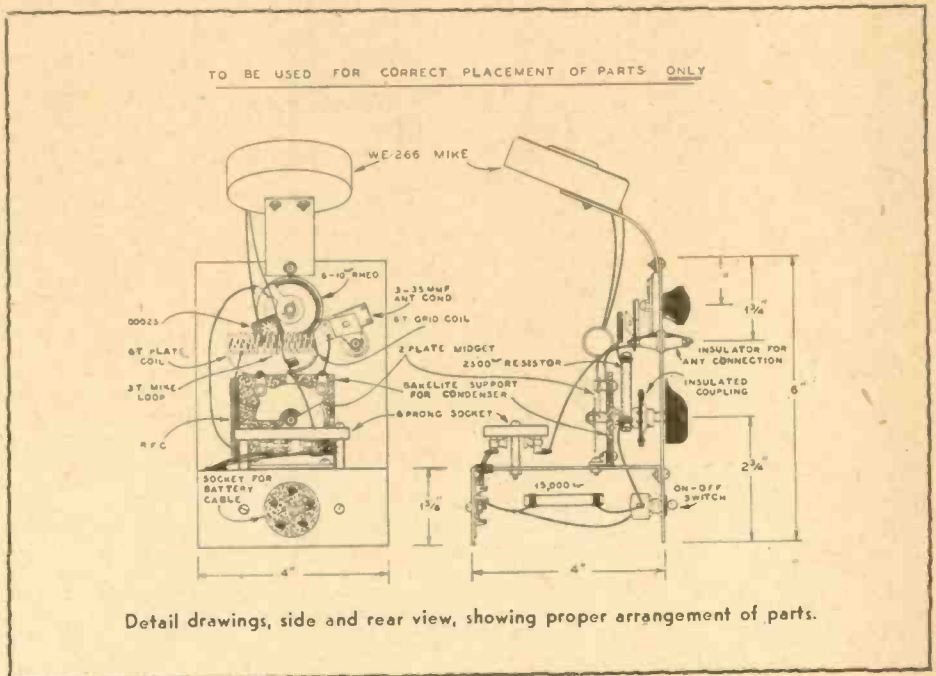

Detail drawings, side and rear view, showing proper arrangement of parts.

A Compact 5-Meter Auto Set

triode unit. This simplifies the circuit and gives ample volume for headset operation. The headset or telephone receivers should be of the high impedance type, any value from 1,000 to 5,000 ohms. When transmitting, this triode unit acts as a monitor, giving sidetone of the speech in the headset. A person can tell easily whether the mike is functioning properly because the modulation should be audible in the telephone receivers in the send position. Receive position of the switch should give a strong hiss, unless the tuning circuit is adjusted to a carrier of some other transmitter or oscillator. Too-close coupling of the microphone loop coil will pull the detector out of super-regeneration.

The tuned circuit consists of a two plate tuning condenser, two similar coils and a small mica grid-blocking condenser. The latter, plus the grid leak, causes super-regeneration in the receive position. When transmitting, the receiver grid leak is shorted-out and only the 2,500 ohm grid leak is left in the circuit. The two coils can be wound with No. 12 or No. 14 copper wire on a $\frac{3}{8}$ inch rod as a winding form. The turns are removed and spaced to occupy about $\frac{3}{4}$ inch to 1 inch length for each coil. These two coils make a continuous winding with the mica condenser in the center and the tuning condenser across the outside. The latter must have an insulated coupling on its shaft in order to prevent hand-capacity and short circuit to the metal front panel.

The radio-frequency choke consists of about 50 turns of No. 22 DSC wire, $\frac{3}{16}$ inch in diameter. This coil is made by winding the wire on a $\frac{3}{16}$ inch diameter rod and slipping the coil off when enough turns are wound. The coil is rigid enough so that its two ends will hold it in place, as shown in the diagrams.

The filament rheostat should only be turned up high enough to cause good super-regeneration when receiving with a reasonable amount of antenna coupling capacity. If no super-regeneration is obtained, and if the circuit has been carefully checked, the trouble may be in a faulty tube. Connections to the batteries are important for correct polarity. Too much antenna coupling may cause trouble and first adjustments should be made without an antenna. All connections should be soldered and the leads kept as short as possible. The two plate tuning condenser can be made by removing one plate from a standard 3-plate midjet condenser available on the market. If the grid condenser is too small in actual capacity due to incorrect rating, super-regeneration may not be obtained.

It should be remembered that any transmitter radiates receiver whistles strongly over a distance of a mile or two and thus consideration in its operation should be given to other nearby amateurs. In transmitting, a strong carrier will be radiated and the only trouble one is likely to have is in obtaining sufficient modulation of a good character. The two principal adjustments are the coupling between coils and the filament rheostat setting.

For 5 meter work the antenna should be a half wave vertical rod or wire about 8 feet long. It should be as high as possible. In some cases it may be necessary to use a RF feeder. A simple feeder is a single wire attached to the 8 foot antenna, 14 inches below its center. This wire can be any length up to a hundred feet and should run off for at least 3 or 4 feet at right angles to the antenna. A two wire feeder is more efficient; in this case one wire connects to the antenna post and the other to the aluminum chassis.

In adjusting the transmitter it is desirable to have another receiver nearby in order to

(Continued on page 28)

• The circuit and set here shown were designed for use in an automobile where a carrier output of about two to three watts is desired. Class A modulation, driven quite hard, is used to modulate one of the new 6A6 tube oscillators. The ordinary transmitter has insufficient power output to transmit over flat country from a moving car, such as is necessary for some types of amateur work or police operations.

The receiver has a stage of tuned RF in order to give a slight increase of sensitivity and to prevent radiation from the super-regenerative detector. The latter uses a 6A6 tube in order to reduce the number of tubes in the set because the 6A6 can also be used as the first stage of audio amplification. The 42 tube modulator acts as the second stage of audio for loudspeaker reception when the send-receive switch is on receive position. The 6A6 detector has another advantage in that it will take a strong signal without audio distortion to better value than a 37 or 76 super-regenerative detector. The second triode unit in the 6A6 acts as a high mu resistance-coupled audio stage. The mike transformer gives a step-up ratio in receive position for the audio ampli-

fier. This additional audio gain is not usually needed but the center-tap also prevents the 6A6 plate circuit and 100,000 ohm resistor from loading the modulator down too much in the transmit position. If the 6A6 plate is

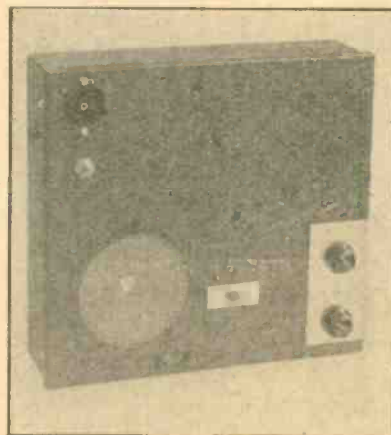

The container for this 5-meter auto set is only 3 inches deep and will easily find a place for itself in almost any car.

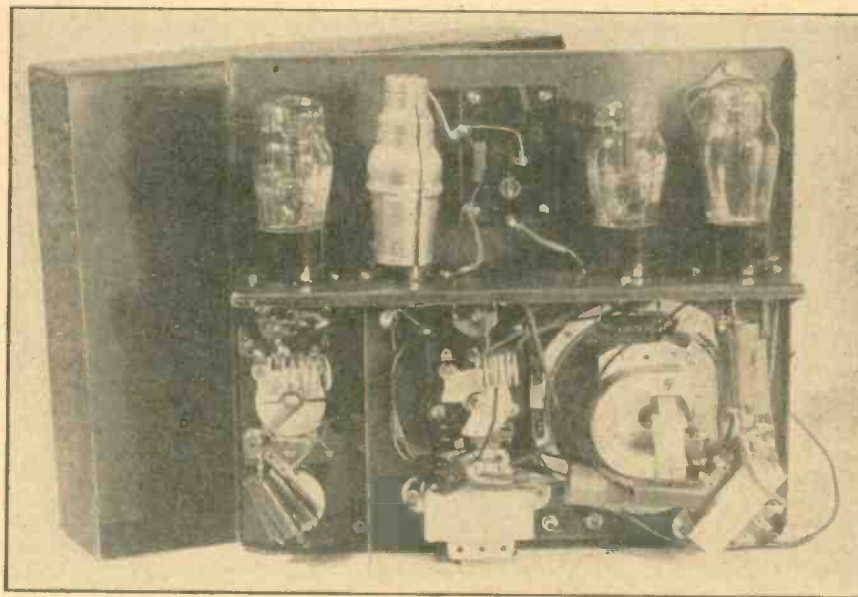

Inside view of the 5-meter auto set. There is a shield partition between the coils. The four tubes are all on one shelf.

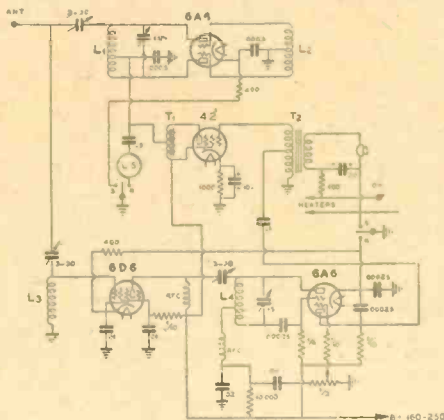

CIRCUIT DIAGRAM

- L1—6 turns, No. 12 wire, $\frac{5}{8}$ -in. dia., $\frac{3}{4}$ -in. long.
 - L2—15 turns, No. 14 wire, $\frac{1}{2}$ -in. dia., $1\frac{1}{2}$ -in. long.
 - L3—18 turns, No. 22 DSC wire, $\frac{3}{8}$ -in. dia., $\frac{1}{4}$ -in. dia.
 - L4—6 turns, No. 12 wire, $\frac{5}{8}$ -in. dia., $1\frac{1}{4}$ -in. long.
 - T1—Center-tap 30 henry choke, 100 MA rating.
 - T2—Mike transformer with secondary center-tapped.
 - RFC—60 turns No. 30 DSC wire, $\frac{3}{8}$ -in. dia.
- Send-Receive Switch is a D.P.D.T.

connected across the entire secondary of the mike transformer it would be necessary to have an additional switch to cut this load off while transmitting.

The tuned RF uses a resonant grid coil. The latter resonates with the tube and antenna coupling capacities to the low frequency end of the amateur band, or preferably just outside of the band if the transmitter is to be used near that end of the band. This stage must be detuned by 2 megacycles, from the transmitter, if no power is to be absorbed from the transmitter. It was found that if the usual condenser and coil arrangement was used, some power would be absorbed up to 3 MC off resonance. By using a very low C, semi-tuned circuit, the RF gain is fairly good over the entire amateur band—about two points on the "R" scale over that of a receiver with an untuned RF stage. This grid coil is made by winding 18 turns of No. 22 DSC wire on a quarter-inch diameter rod to cover a length of $\frac{3}{4}$ inch. The coil is slipped off the rod and supported by its ends soldered to a pair of

(Continued on page 24)

The Browning 35 With Tobe Tuner

PART II

By GLENN H. BROWNING*

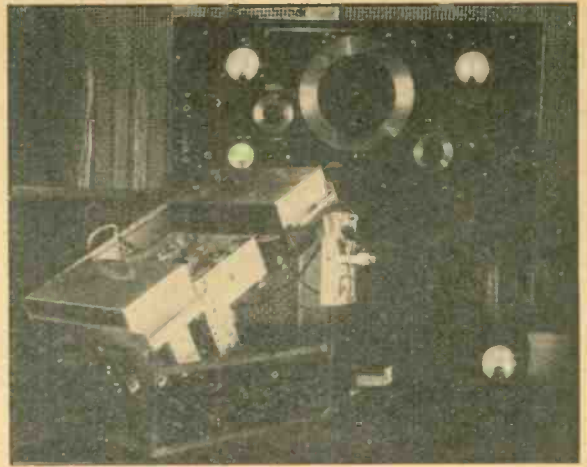

THE February issue of "RADIO" has already described the fundamental principles involved in an all-wave superheterodyne especially designed for the set-builder, experimenter, and amateur. The receiver consists essentially of a tuned-antenna circuit followed by a stage of RF amplification on all bands; an electron-coupled oscillator, a double-band pass intermediate stage, an automatic volume control which may be switched on or off at will, and a beat-frequency oscillator for CW reception. The antenna, RF, and oscillator coils are all mounted in a catacomb which shields the individual circuits. In this same catacomb is the switch for changing coils on the four separate bands provided. This switch has silver-plated wiping contacts and is so arranged that all coils not being used are short-circuited, thus insuring no dead spots in the tuning range due to absorption in resonant circuits. On top of the catacomb is mounted a gang of three tuning condensers which are designed to have an extremely low minimum capacity, so that the inductance of the coils may be maximum and the tuning range improved. The receiver is absolutely single control. Band spread is accomplished by a micro-vernier dial with a ratio of 40 to 1. Stations are logged by reference to two pointers, one rotated on the main shaft of the tuning condenser, and the other on the vernier shaft. The complete coil, condenser tuning assembly is made in one unit, and wired and accurately tracked in a completely assembled receiver so that the set builder has only to make seven connections to this Tobe Tuner in constructing his receiver.

The receiver covers a range of frequencies of from .55 to 22.6 megacycles, and, due to the extreme care in design, layout, and selection of parts, has a sensitivity of 1. microvolt or less all over the tuning range. In fact, the sensitivity is greater than can be used except under the most favorable atmospheric conditions. Fig. 1 shows sensitivity

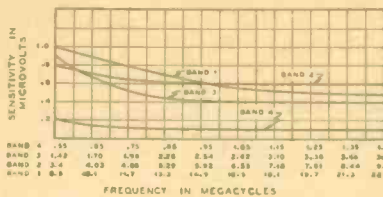

FIG. 1—Sensitivity Curves.

curves on the four bands. It will be noted that the response is almost uniform on any one band.

A great deal of design study was given the

* Chief Engineer of the Tobe Deutschmann Corp. (Part III will follow in the next issue)

intermediate amplifier for it was desired to have the highest quality response which was possible without allowing station overlap. This work resulted in the use of three high Q circuits in each of the two intermediate transformers. Each of the six inductances which are tuned are in turn made up of a series of three pie windings, which results in lowering the distributed capacity of the coils and materially sharpens the individual tuned circuits. The resultant resonance curve for the IF amplifier has already been shown in "RADIO" so that it remains to picture the overall selectivity of the receiver which is due to the tuned antenna circuit, RF, and intermediate amplifiers as a whole. Fig. 2 shows such curves taken at 600 and 1000 KC. It will be noted that the "nose" of these curves is very broad, but that the sides are relatively steep. This means that the high audio frequencies in the received music which are so necessary for high quality reception are attenuated very little, but that 10 KC selectivity is assured. For example, a note of 2500 cycles in the received music would be reduced only 37 per cent or about 4 decibels while the interference of a station operating on an adjacent channel 10 KC away would be reduced some 99.2 or about 40 decibels. This broad "nose" tuning curve is actually noticeable in operating the receiver for the micro-vernier tuning control may be rotated several degrees on broadcast without a noticeable change in signal level, however rotating it a fraction of a degree farther entirely tunes out the signal. This may readily be seen to be the case from the selectivity curves. For the operator in tuning the micro-vernier in effect slowly slides the whole tuning curve to the right or the left of the signal's carrier which remains stationary and when he reaches the steep

portion of the curve the signal decreases very rapidly.

Great care has been taken throughout in the selection of parts, for the completed receiver is no better than its components. The set is put out in kit form. The base and panel are drilled and finished so that the assembly

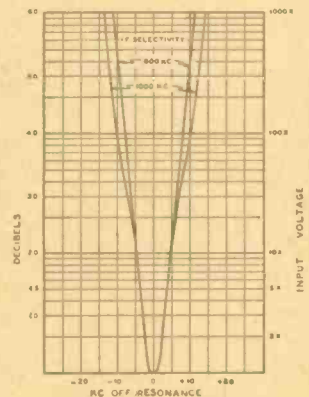
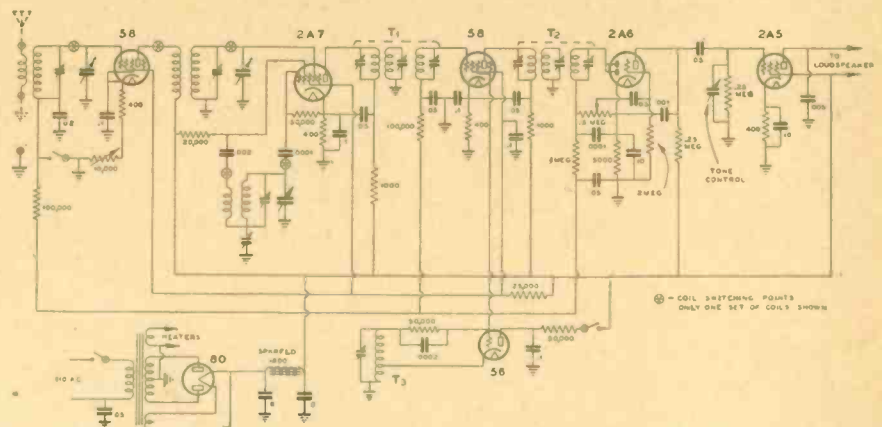

FIG. 2—Overall Selectivity.

of the parts is relatively simple. Fig. 3 and the pictures show a top and bottom view of the apparatus mounted on the chassis. It is advisable to mount all of the tube sockets and shield bases first. The same mounting screws are used for both, the tube socket being held below the chassis and the tube shield base above. It is important to have the tube socket contacts in the position shown on the diagrams, for care has been taken to make all leads carrying radio frequency current as short as possible. The insulating straps should then be fastened in the positions shown on the drawing. The power transformer is mounted as indicated,



- 1—Tobe-35 Tuner.—Consists of four sets of coils L1, L2, L3, L4, L5, L6 with * tuning and trimmer condensers and change-over switch for the four bands all mounted within one container.
- 2—X—Points where coils are switched. (Diagram shows only one set of coils.)
- 8—Resistors all 1/4 watt unless otherwise specified.

and the filament wiring done. As will be noted the transformer has a 2.5 and a 6.3 filament winding so that either 6.3 or 2.5 volt tubes may be used according to the set builder's desire. The 2.5 and 6.3 volt tubes are identical in their electrical characteristics even to having the same input and output capacitances and fit the same sockets, that is, the 58 equals the 6D6, the 2A7 equals the 6A7, the 2A6 equals the 75, the 56 equals the 76, and the 2A5 equals the 42. The transformer has an electrostatic shield between the primary and secondary windings which helps to eliminate any noise being fed into the set from the lighting circuit and at the same time eliminate a modulation hum sometimes encountered. However, even with this electrostatic shield it was thought advisable to place an .05 mfd. condenser across the primary, for in some cases this further reduces line noise. With this condenser across the lighting circuit, one side of which is usually grounded, a voltage may be obtained between the metal chassis and a ground wire attached to a water pipe or radiator. This is not harmful, but a slight shock will be obtained upon taking hold of the ground wire and the chassis at the same time. Reversing the plug in the 110-volt outlet will eliminate this voltage in practically all cases. The writer simply mentions this effect and its cause and cure so that the set builder will not think he has made a mistake in wiring.

The IF transformers should be mounted so that the adjusting screws on T2 face the side of the chassis. These IF transformers have been carefully adjusted at the factory to the intermediate frequency of 456 KC and care should be taken not to change their adjustments. After the filaments are wired, the screen grids, power supply, and plus B leads should be connected. These leads should be run along the bottom of the chassis out of the way. The IF transformer leads are then soldered in place. These leads are cut to length and if they are not long enough to reach the proper connections some of the parts must be mounted incorrectly. The resistors and by-pass condensers should then be soldered into place. The placement of these has been worked out so that they mount either on the tube sockets themselves or on the insulating straps provided for that purpose. This placement is shown on the drawing and should be followed. Be sure to follow the wiring diagram in by-passing, for a number of the condenser leads return to the cathode of the tubes and not to ground.

The volume controls and switches on the front of the chassis may be temporarily mounted and wired. (This temporary mounting will have to be removed when the front panel is put on as these controls hold the front panel to the chassis.)

The last apparatus to mount is the tuner which carries the gang of three tuning condensers together with the coil and switch assembly. This is mounted on soft rubber grommets which should be placed between the main chassis and the tuner. Besides the grommet an insulating washer is furnished which is placed on the other side of the tuner chassis before the metal washer is put in place. The nuts which hold the complete assembly should be just slightly tightened so that the tuner cannot slide around. Under these circumstances the rubber grommets will give a cushion effect which tends to reduce mechanical acoustical feedback caused by the actual vibration of the condenser plates due to the sound waves from the loud speaker.

Great care should be taken in handling the tuner for it is completely wired and very carefully tracked at the factory. This tracking is done in a complete receiver identical

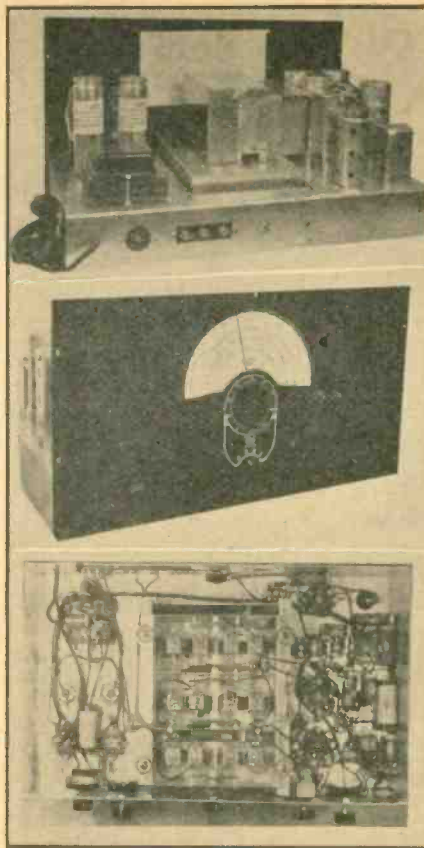

Rear, Front and Under-Chassis Views of Browning 35 With Tobo Tuner

to the one the set builder has constructed. This exact alignment is obtained by means of an all-wave signal generator with a calibrated attenuator so that absolute sensitivity of the tuner is measured after the tracking is done. There are three connections leading into the tuner which should be as short as possible. One is from the plate of the first 58 tube which is used as a radio frequency amplifier. This lead should be flexible and run directly from the plate to the terminal provided in the middle compartment of the tuner. This lead should be kept as far as possible away from all other leads and also a reasonable distance away from the metal chassis. It will be noted from the wiring diagram that grid No. 1 of the 2A7 or 6A7 is connected to the tuner through a .0001 mfd. condenser. This is one of the small mica condensers furnished in the kit and should be mounted on the tube socket of the 2A7 in a vertical position. A flexible lead is connected to the proper terminal which will be found in the rear compartment of the tuner. The anode, or grid No. 2 of the 2A7, also connects to the tuner through a .002 mica condenser. This should be connected on the tube socket similar to the one just described, and flexible leads run over to the tuner as previously stated. These three leads carry high frequency current and their capacity should be kept down to a minimum which means that they should be as far away from the chassis and other leads as reasonably possible and at the same time short. The other connection to the tuner on the left goes to the automatic volume control .1 meg resistor. The three connections on the right of the tuner go to the doublet antenna and plus B supply. In running the doublet leads into the tuner from the binding posts provided in the rear, care should be taken not to have these leads directly over any of the coils in the tuner. Otherwise, some feedback between circuits might be encountered.

It will be noted that the tuner has a flexible metal lead soldered to it. The other end of this lead should be well soldered to the main chassis. Grounding the tuner in one point only is essential for the elimination of chassis currents.

The receiver is now ready for assembly of the front panel, and the dial. Before the front panel is put in place be sure to assemble the long pointer with collar and set screw attached on the main shaft of the tuning condenser. As will be noted, the two volume controls, the automatic volume control switch, and the tone control and power supply switch hold the panel in place. When the panel is mounted by means of these, the coil switch and tuning condenser shaft should extend through the holes in the panel. These holes are ample in size and the shaft should not touch the front panel. Otherwise, some chassis current might be introduced into the tuner, setting up feedbacks and possibly an AC hum.

A short pointer with spring collar attached is provided. This should be slipped over the vernier tuning shaft which extends through the front panel. This should not touch the front panel itself. The dial card may then be slipped into the dial holders in the rear of the front panel. When this is in position, the long pointer should be free to rotate over this card without touching the front panel. A slot has been cut in the dial card which fits over the pointer's collar. The adjustment of the dial is made by this rather than the dial holders as their relative position may change slightly according to the mounting of the rubber grommets. Therefore, the slot in the dial card should fit over the pointer's collar and rest gently on it if the correct calibration is to be maintained.

After carefully checking the wiring of the receiver it is ready for trial operation and if correctly constructed should, when an antenna and ground are connected, bring in signals. If it does not, do not change any alignments on either IF transformers or trimming or padding condensers in the tuner itself. Look for wrong connections elsewhere. In turning over the chassis after the tuner has been assembled care should be taken not to rest it on the three-gang tuning condenser, for the alignment of this condenser might be thrown out even in spite of its rugged construction. After checking the wiring, if no signals are heard the tubes used in the receiver should be checked. (The writer uses RCA standard tubes). In all cases the receiver should receive signals before any changes of alignment are made. Too much cannot be said on this point for if either the band-pass intermediate frequencies or the padding or tuning condensers on the coils are thrown badly out of alignment it requires a rather experienced man to adjust them properly on a sensitive single-control receiver such as this.

As previously stated, every precaution has been taken in the manufacture of the tuner and the IF transformers to have them perfectly aligned. However, tube capacitances differ slightly and it may be necessary to make slight adjustments on both the tuner and the IF transformers. However, it would be well to try out the receiver thoroughly before any adjustments are made on these parts. For final slight adjustments, the following directions are given to the set builders who do not have available either an output meter or an all-wave service signal generator:

Instructions for Final Adjustment of Receiver on Noise in Case This Is Found Necessary

Lining up IF transformers:

- (1) Remove antenna lead.
- (2) Turn both volume controls to the

(Continued on page 34)

10-Watt 160-Meter Phone Using Low-Cost Tubes

By the LABORATORY STAFF

● Many CW amateurs have found it too costly to change to phone operation. The cost of the audio equipment is one of the factors which keeps many a would-be phone operator on CW, not to mention the cost of tubes in the speech equipment.

A 160-meter phone of good output, and using the most inexpensive types of tubes has been designed by the technical staff of "RADIO". The RF portion uses a single '47 in the crystal oscillator stage and two type 45 tubes in parallel in the RF amplifier stage. 15 watts of output can readily be

secured from this tube line-up. The crystal oscillator stage uses the "chirpless" keying feature for optional CW operation. The key is in the center-tap resistor of the filament circuit of the 47 oscillator tube, and the value of the center-tap resistor is 20 ohms.

A 15,000-ohm resistor is large enough in value for the crystal oscillator grid leak, and this resistor is in series with an ordinary HF

radio-frequency choke of the conventional small size.

160-meter crystals are not "tricky" or "cranky", as a general rule, and thus the use of a 15,000 ohm grid leak resistor is entirely suitable. A 150 mmf. midget variable condenser is used to tune the plate tank coil of the crystal oscillator stage. The conventional 100 mmf. midget variables are a bit too small for conveniently tuning a 160 meter coil. Of course, a condenser larger in value than 150 mmf. could be used, if desired. For ease of tuning and adjustment, it is better to wind the 160-meter coils on large-diameter coil forms. The ceramic or Bakelite forms, 2 1/4 inches in diameter and 3 1/2 inches long, four-prong type, are ideal for 160-meter work. Coil forms of this size are made by various manufacturers, or the constructor can use ordinary bakelite tubing for coil forms. The convenience of factory-made plug-in coil forms is evidenced when multi-band operation is desired. The oscillator plate coil is wound with 55 turns of No. 20 or No. 22 DCC wire, close wound. The winding space is approximately 2 1/2 inches.

A .01 mfd mica condenser, 1000 volt rating, is connected from the bottom of the oscillator plate coil to ground, as the circuit diagram shows. The screen by-pass condenser is .01 mfd. and an ordinary 600 volt paper condenser can be used here, although it is far more desirable to use mica condensers throughout. The slight extra cost is worth the added protection they give.

The crystal oscillator stage is link-coupled to the grid coil of the '45 amplifier stage. Link coupling calls for the use of a grid coil and a grid-coil-tuning condenser. The cost of these items is offset, in great measure, by the marked increase in efficiency which is secured when link coupling is used in place of capacity coupling. Link coupling also practically eliminates 99 per cent of the "bugs" inherent in capacity coupling systems.

The grid coil is wound with 52 turns of No. 22 DCC wire on a 2 1/4-in. dia. form. However, a tap is taken from the grid coil at the center of the winding. This is the grid-leak tap, to which the 25,000 ohm, 5 watt resistor connects. The grid coil is tuned with a two-section midget variable condenser, 140 mmf. each section. The rotor of this two-section condenser is connected to ground. A closed-circuit jack in series with the grid leak and ground enables grid-current reading to be made by use of a 0-100 MA DC milliammeter. In this circuit, neutralization is also indicated, as explained later. The meter can be plugged into the plate circuit of the oscillator stage for reading plate current, or it can be plugged into the plate circuit of the final amplifier stage to read its plate current. Thus only one meter is required. It performs the following functions, in the order named: (1) oscillator plate current reading; (2) grid current reading and neutralization indication; (3) plate current reading of the final amplifier stage.

Two type 45 tubes are used in the final amplifier. These tubes are connected in parallel. A 20 ohm center-tap resistor is connected across the filament leads and the center-tap is then connected to a 1300 ohm resistor. The latter is shunted with a 4 mfd. condenser. The lower side of the resistor and condenser connects to ground. A .001 mfd. 1000 volt mica condenser is in series with the plates of the 45 tubes and the final tank coil. Plate current for the final stage is fed to the plates through a 200 MA RF transmitter choke. The final plate coil is wound on the same size form as used for the oscillator and grid coils. The final plate coil has

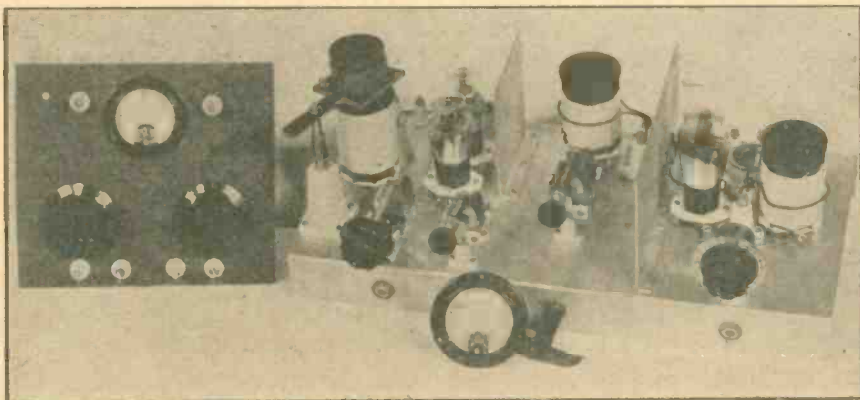

'47 Oscillator, Link-Coupled to a pair of '45s in parallel. Antenna Condensers and RF Ammeter are Mounted on the Panel at Left.

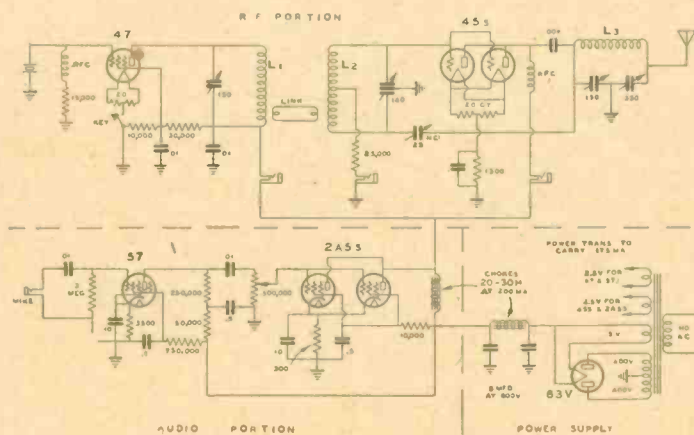

Circuit Diagram of the Entire Transmitter.

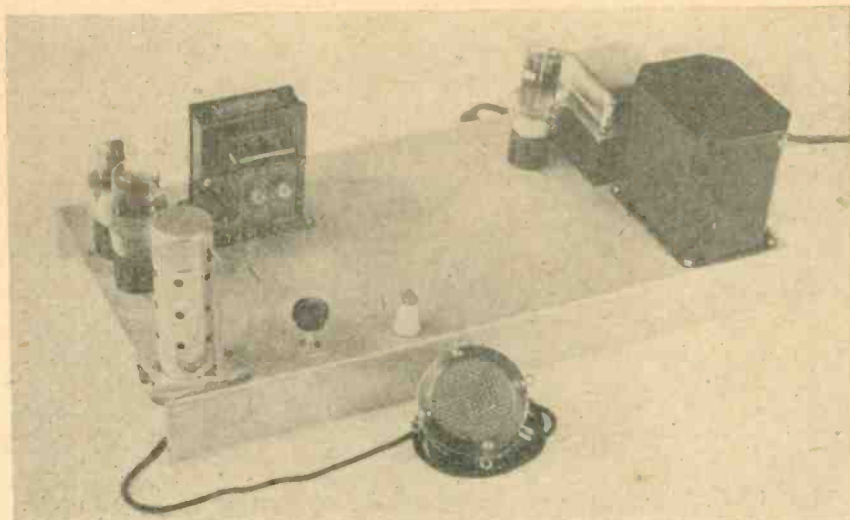

The Power Supply and Audio Channel. Wide separation of parts prevents hum pick-up. The crystal microphone feeds directly into the 6C6 tube.

from 55 to 60 turns of No. 20 DCC wire, close wound, covering a winding space of about 3 inches. A 150 mmf. wide-spaced condenser is used to tune the final plate coil.

Such a condenser can be a .0005 receiving type variable condenser with alternate plates removed, or a standard double-spaced 150 mmf. condenser of any good grade. The plate tuning condenser used in the final amplifier illustrated in the photograph is a dual-section, 35 mmf. per section, wide-spaced Hammarlund. The two sections are connected in parallel and thus a 70 mmf. wide-spaced condenser is the result. The diagram shows the method of coupling the final amplifier to the antenna. This method is quite novel, in that it is the acme of simplicity, yet gives very good results. Any kind of a single wire antenna can be used, from 55 to 150 feet long. A good earth ground (not water pipe) is connected to the rotors of both tuning condensers, as the diagram shows. Such a ground can be had by driving several pieces of pipe into moist earth and connecting the pipes together with ground clamp connectors. This type of ground tends to reduce interference with BCL reception in the immediate vicinity where the phone transmitter is in operation. The 350 mmf. variable condenser in series between the bottom of the final plate coil and ground can be of the ordinary receiving type. The antenna is tuned by adjusting both condensers simultaneously until maximum resonance is indicated by a lamp in the antenna circuit but, at the same time, when minimum mills are drawn by the plates of the final amplifier tubes. The indicating lamp should not be left in the antenna circuit after the transmitter is tuned. The final plate coil should be tapped, for best results. A tap is taken at the 5th, 10th, 15th and 20th turns from the bottom end of the coil (end nearest ground) and the antenna connected on the tap which gives best results.

Power Supply

The power supply is somewhat novel; only one power supply is needed for the entire transmitter. It uses a heavy-duty power transformer, 400 volts each side of secondary center-tap, at 175 MA. It must have two separate 2½-volt filament windings; if it has but one 2½ volt winding a separate 2½ volt filament transformer can be added. The 45 tubes in the final amplifier must not operate from the same filament winding that lights the filament of the 47 oscillator and the audio tubes. An 83V rectifier tube is used. This is a comparatively new tube. It uses a cathode heater. Two 8 mfd. 600 working volt condensers are required. Make sure that they will stand 600 volts. The choke is a 200 MA, 20 to 30 henry size. The power unit should deliver 400 volts at the output terminals when the transmitter is in operation.

The Audio Amplifier

The audio system is simple. A 57 tube drives two 2A5s in parallel. These tubes are in the low-price group. A crystal microphone can be connected to the input, or any other type of good microphone can be used. The .01 mfd. condenser in series with one of the mike leads and the grid (cap) of the 57 tube must withstand 1000 volts, and thus a mica condenser is recommended. A 3 megohm resistor is shunted from grid of the 57 tube to ground. The cathode bias resistor of the 57 tube has a value of 3,500 ohms and it is shunted with a 10 mfd. 25 volt paper condenser. The screen of the 57 tube derives its voltage from the plate supply through a 750,000 ohm resistor, and another resistor of 500,000 ohms is connected from the screen to ground. At the junction where the 750,000 ohm and the 500,000 ohm resistor connect together, a .1

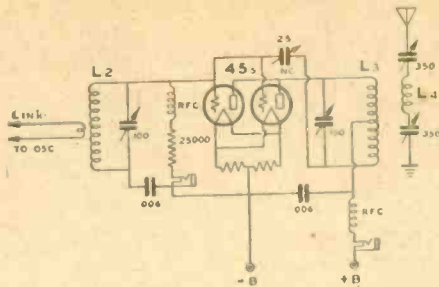

This transmitter can be made more simple if a very slight reduction in efficiency is acceptable. The circuit above shows an alternate final amplifier for greater simplicity. A 100 mmf. midget variable section condenser, instead of a split-stator condenser is used to tune the grid coil, L3. This grid coil is wound on a 2¼-in. dia. form, with 50 turns of No. 22 DCC wire, close wound. The coupling link from the oscillator stage is placed near the center of the grid coil. The plate tuning condenser in the final stage should be double spaced to prevent flash-over. A different form of antenna coupling is also shown. The antenna coil, L4, is wound with 45 turns of No. 22 DCC or DCC wire and this coil is placed on top of the plate coil, L3. The coupling of coil L4 must be variable. .00035 mfd receiving type variable condensers are used to tune coil L3. One condenser is in series with the antenna, the other in series with the ground or counterpoise.

mfd., 400 volt paper condenser connects to ground.

The plate of the 57 tube feeds the grids of the two 2A5s through a .01 mica condenser, 1000 volt rating. The gain control is a 500,000 ohm variable resistor (potentiometer). The center arm of this variable resistor connects to the grid of both 2A5 tubes. The cathodes of the 2A5s are in parallel, and a 300 ohm resistor is in series with cathodes and ground. This resistor is shunted with a 10 mfd., 25 volt paper condenser. The screen of the 2A5s get their voltage from the power supply through a 10,000 ohm, 10 watt resistor. A ½ mfd. 600 volt paper condenser is connected from screens to ground. The audio choke is a 200 MA, 20 to 30 henry size.

Tuning

The oscillator is tuned first. The tank condenser across the oscillator coil is rotated until resonance is indicated by a pronounced dip in the reading of the milliammeter which is plugged into the jack in the plate circuit of the oscillator stage. When this resonance point has been found, change the variable condenser setting very slightly, so that approximately 20 to 30 mills are drawn by the oscillator tube. The oscillator stage is tuned with the final stage disconnected, and the coupling link removed from the grid coil.

Now place one end of the coupling loop over the grid coil; the loop should encircle the center of the grid coil. Place the other loop of the coupling link around the bottom of the oscillator coil. Disconnect the plate supply from the final stage, but light the filaments of the two 45 tubes. Turn the oscillator on. Now tune the grid coil condenser until the meter in the grid coil circuit reads MAXIMUM current. Make sure the oscillator stage is oscillating when the grid circuit is being tuned.

Usually, about 10 to 12 mills will be the reading of the grid current for the amplifier stage. If less than 10 mills is had in the grid circuit, raise the coupling loop around the oscillator coil so that it is near the center of the oscillator coil.

When the grid coil is tuned to exact resonance, as indicated by maximum reading of the milliammeter in the grid circuit, it is often found that the oscillator stage stops

oscillating just previous to the time that maximum grid current is indicated. This proves that the coupling is "too tight". Change the position of the coupling loops on the oscillator and grid coils until maximum grid current is secured. While tuning the grid coil, occasionally plug the milliammeter into the oscillator circuit jack to make sure the oscillator is oscillating. A more convenient method for tuning the grid circuit would be to place a small flashlight globe and loop over the oscillator coil (very loosely coupled to the oscillator coil) and keep one eye on this flashlight globe to see that it remains lighted at all times while the grid coil is being tuned with the aid of the milliammeter. Some slight retuning of the oscillator plate condenser is always necessary while tuning the grid coil. The coupling link between oscillator and grid coil can be an ordinary twisted pair of No. 22 push-back wire. Do not use lamp cord. The loops around the oscillator and plate coils can also be push-back wire, and these loops are simply wound around the coils (one turn used for the loop) and held securely in place by standoff insulator supports or by merely tightening-up on the loop itself. Unusual precautions need be taken, because there is but little power transferred from oscillator to grid in this small transmitter.

RF Chokes

For 160 meter operation it is desirable to use two RF chokes in series; one an ordinary short-wave type, the other a standard broadcast band receiving type RF choke.

Neutralizing

With the oscillator oscillating, with the grid circuit tuned to resonance, with the filaments of all RF tubes lighted, but with the plate voltage disconnected from the final amplifier stage, the neutralizing process is ready to begin. Plug the milliammeter into the grid circuit. Place the flashlight tuning lamp over the oscillator coil. Keep your eye on both. Rotate the 25 mmf neutralizing condenser slowly. Begin neutralizing with minimum capacity in the 25 mmf neutralizing condenser. Then rotate the plate tuning condenser of the final amplifier over its entire radius. As you rotate this condenser you will find that the milliammeter in the grid circuit will take several pronounced dips with various settings of the final plate tuning condenser. This is an indication that the neutralizing condenser is not properly adjusted. Slowly increase the capacity of the neutralizing condenser; swing the final stage plate condenser back and forth over its entire radius. Repeat this process, very slowly, adding or decreasing capacity in the neutralizing condenser. You will find one setting of the neutralizing condenser that will enable you to rotate the final plate tuning condenser through its entire radius without any variation of grid current whatsoever, as indicated by the milliammeter in the grid circuit. The process is made extremely simple by merely remembering that the milliammeter in the grid circuit will show absolutely no variation in reading, no matter where the final plate tuning condenser is set, when the stage is completely neutralized.

After the final amplifier is neutralized, plug the milliammeter into the plate circuit jack and connect the high voltage plate current to the final amplifier. The final amplifier is tuned to resonance by finding a setting of the final plate tuning condenser at which the milliammeter shows a very pronounced dip. The resonance point is indicated by a reading of about 10 or 12 milliamperes on the meter, with the antenna disconnected from the plate circuit.

Now couple the antenna to the plate coil. Tune the antenna condenser and also slightly retune the plate condenser of the final stage

(Continued on page 32)

A Simple, Inexpensive 4-Tube, 5-Meter Superheterodyne

It Uses No I. F. Transformers

By FRANK C. JONES

• A simple superheterodyne which anyone can easily build in a few hours has at last been developed for use on the short wave bands below ten meters. The circuit is not at all complicated and no special parts or alignments are necessary in order to put one of these sets on the 5 meter band. The receiver is much more sensitive than a super-regenerative type and has none of the usual loud hiss so common in the latter type.

Briefly, the circuit consists of an autodyne first detector, a "tuned" resistance coupled

two stage I. F. amplifier, and a second detector. Four tubes give real results on five meters. It tunes easily because the I. F. amplifier passes a wide band of frequencies. The parts cost very little more than those needed for a super-regenerative receiver. This super does not radiate nearly as much as a super-regenerative set. Several of these re-

ceivers can be used in a neighborhood without causing interference with each other because it is not likely that the oscillating first detectors would be tuned to the same frequency within 5 KC even when all sets are tuned to the same station. The tubes are oscillating weakly, anyway, and only on one frequency to which the circuit is tuned, instead of over a band of 100 to 200 KC as in a super-regenerative detector.

The first detector tunes like a regenerative, oscillating detector used for 40 meter CW reception. That is, there are two points very close together on the dial where each station will be heard. In this receiver these points are so close together that the dial is merely set to either side of the exact center of any station by about a half degree or so at which points the quality is best, and the signal loudest, due to its being heterodyned properly into the IF amplifier. The first detector uses a RF choke in series with the cathode to obtain oscillation because this is simpler than finding the exact point on the tuned circuit for the cathode tap, as in the usual electron coupled oscillator. This form of oscillator gives good stability even on 5 meters.

The IF amplifier is the really interesting part of this receiver. It gives good amplification over the band of frequencies desired, from 10 KC to a little over 100 KC, and is quite stable. The secret is in using the proper values of resistors and condensers to obtain this resonance characteristic. By using low values of grid resistors, $\frac{1}{4}$ megohms, and small coupling condensers, .0001 mfd., the response to audio frequencies is practically nil. There is no tendency to motor-boat since it is such a poor audio amplifier. This also prevents the rectified audio signal component in the first detector from being amplified all the way through the receiver. This value of coupling condenser (.0001 mfd.) and a grid leak of $\frac{1}{4}$ megohm does not tend to attenuate the higher frequencies such, as for example, 50 KC. This means that the first detector can be of the autodyne type and act as its own oscillator. By having it oscillate weakly, the tube is in its most sensitive condition, which accounts for the excellent signal to noise ratio obtained in this receiver. It also eliminates the need of tracking two tuned circuits, such as used in most superheterodyne receivers.

The relatively low values of plate resistors of 50,000 ohms tend to even-out the amplification of the IF amplifier for the range of 50 to 100 KC in order to be able to receive modulated oscillators. Probably 98% of the phone transmitters on 5 meters use modulated oscillators, so it is necessary to have a receiver tuned broadly enough to receive these signals. Even if all transmitters were temperature and crystal controlled types, it would still be desirable to have the IF amplifier broadly tuned in order to take care of oscillator drift in the receiver. Two stages of moderate gain per stage give more than enough amplification to bring up the man-made noise level into audibility in the output of the second detector. Automobile ignition is the worst offender, although neon signs and other electrical appliances cause plenty of interference up to a hundred feet or so from where the receiver is located.

Volume control is obtained by means of variable cathode bias on the IF amplifier because variable mu tubes are used. Tubes

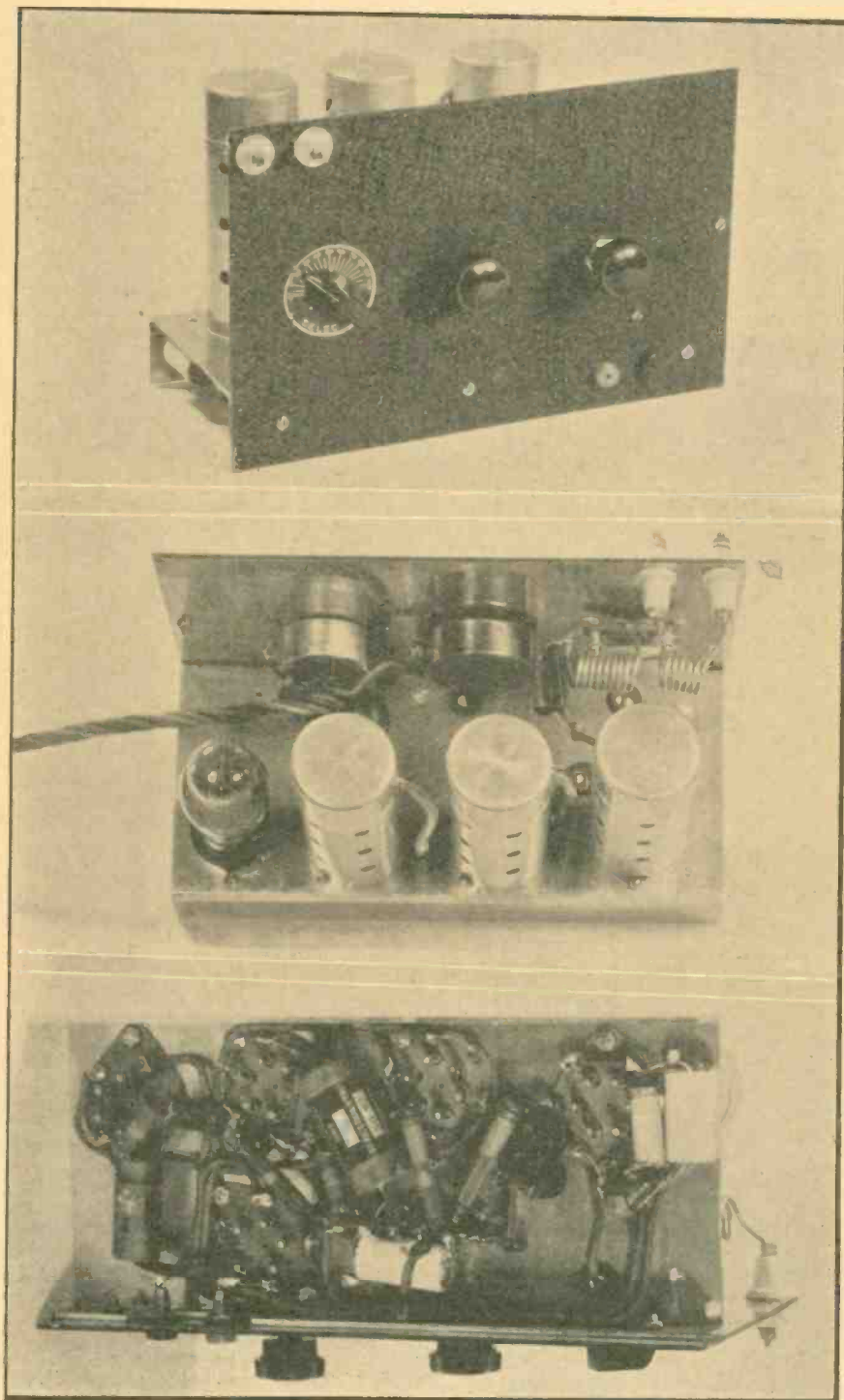

Three Views of the 4-Tube 5-Meter Super. It is the Acme of Simplicity

Adding R. F. to the "222" Receiver

By FRANK C. JONES

THE demand for a simple receiver, such as the original model 222 Communication receiver, but with a radio frequency stage ahead of the detector, prompted the design and construction of the superheterodyne herein described. Adding the usual tuned RF stage means complications because of the need of complete shielding and circuit isolation between the RF and regenerative detector stages. For this reason a semi-tuned RF stage was chosen and thus the receiver is no more complicated than the original 222 receiver.

The form of RF stage used here is self tuned over a narrow band, which is an ideal condition for amateur reception but would not be satisfactory for an all-wave broadcast receiver. The input circuit uses a resonant RF choke or tuned circuit which has a high L over C ratio. This means real amplification where it is needed and not very great selectivity in this stage. The antenna trimmer condenser will actually tune this stage to resonance any place within the amateur bands. One RF coil or choke is needed for each band, as shown in the coil table. The really beautiful part of this type of RF stage for amateur use is that no special amount of shielding and no three-gang condenser is required. No alignment difficulties or circuit reaction are encountered.

The RF chokes can be wound on old burned out Amperites, such as were used with the 201A tubes to drop their filament voltage from 6 down to 5 volts. There is just a little over 1 inch of winding space on these glass tubes which are about 7/16 inch in diameter. The ends of the wire can be soldered to the end clips and the whole unit plugged into the original clip mounting. This makes a fairly convenient method of changing these RF coils for each amateur band. Another possibility would be the use of burned out cartridge type fuses, preferably those having glass instead of fibre cylinder walls.

The antenna condenser, about 25 mmfd. maximum capacity, should be insulated from the front panel. The antenna is connected to the rotor. Probably a doublet antenna could be used by coupling 10 to 20 turns of wire around the tuned RF choke on a form large enough to slip easily over the choke coil. In this case the antenna condenser should connect to ground in order to resonate the input circuit. The actual resonance curve of a high L over C ratio tuned circuit on 20 or 40, or even 80 meters is wide enough to cover the amateur bands without retuning for each station received. This only holds true where the capacity across the tuned circuit is extremely small and where the coils have a certain amount of resistance to help broaden out the selectivity curves.

The RF stage increases the signal to noise ratio, as shown by tests on the 40-meter band by means of an all-wave signal generator. The image rejection of this set is extremely high when considerable regeneration is used in the first detector. When using as much regeneration as possible the image rejection was 68 DB using a non-resonated input circuit, and nearly 80 DB with a resonant input circuit. One of the most expensive commercially-made all-wave receivers using an RF stage measured only 47 DB image rejection on 40 meters.

Analysis of the above shows that very efficient plug-in coils, plus isolantite insulation on condensers and coil sockets and no dead end losses, increase the selectivity for purposes of image rejection. Regeneration in the first detector increases the selectivity against unwanted signals 900 KC off resonance, especially as the regeneration is in-

creased. In this receiver a 100 mmfd. band-setting condenser is at maximum capacity for the 40-meter band to aid image rejection. 80 DB means that the undesired commercial station signal would have to have a field strength at the receiver of 10,000 times that

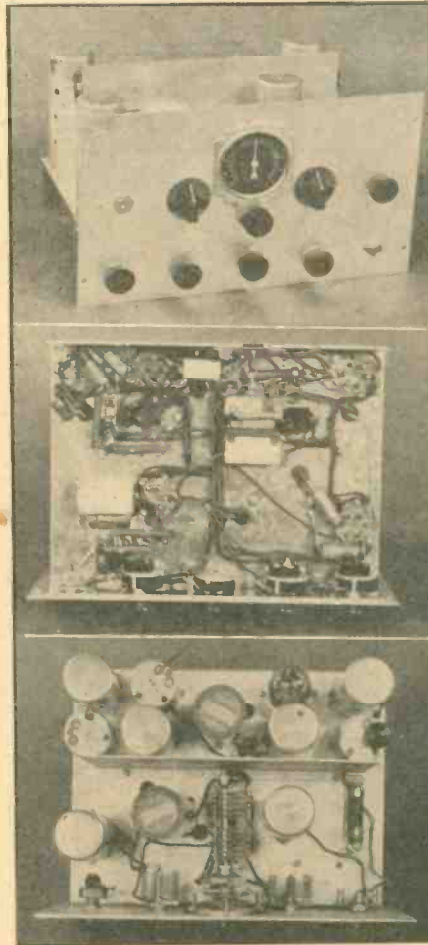

A beautifully-compact and neat appearing receiver is the new 222. Here are the front, bottom and interior views.

of the amateur signal in order to be as loud. The receiver uses a regenerative detector, one stage of IF, detector and one stage of audio amplification for headset operation. If loudspeaker reception is desired an additional audio stage can be used, or the present stage can be transformer coupled to the power detector, with a pentode tube such as a 42 instead of the 76 tube now used in the audio stage.

A separate BFO tube is used for CW work, and a separate Dow electron-coupled first oscillator is used to provide good stability. The first detector is similar to the one used in the original 222 receiver except that less regeneration is needed and consequently less turns are required between cathode tap and ground. The conversion gain of this detector is quite high, due to the suppressor being coupled to the oscillator and having a positive potential on it of about 90 or 100 volts. Running the suppressor at DC cathode or ground potential required a great deal more regeneration coupling to hear the same weak signal from a signal generator.

Both AF and RF plus IF bias volume controls are provided because a good balance between these will often allow the reception of extremely weak signals through local noise conditions. A tone control is provided for the same purpose.

The IF transformers are of a type used in broadcast receivers. They are modified somewhat to the detriment of the symmetry of the coils. The spacing between coils must be increased about 1/4 or 3/8 inch in order to give better IF selectivity. The spacing between coil centers is now slightly over an inch and the particular coils used in this receiver tuned to 432 KC.

The layout of parts in this receiver is quite simple. Only one partition shield is used. The front panel, chassis and cabinet are all made of No. 12 gauge aluminum. It would be desirable to have a shield between the two sections of the band-tuning condenser in order to prevent a slight amount of interlock between the detector and oscillator. The constructor is advised to add

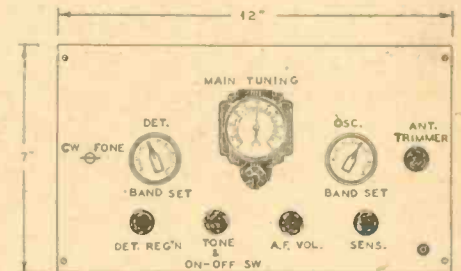

POWER PLUG IN REAR OF CHASSIS

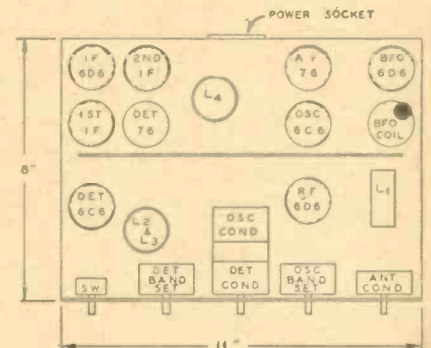

Front Panel layout and parts arrangement.

this shield. It would further be desirable to have a flexible coupling between the dial and this tuning condenser in order to prevent dial binding and CW note "drag." The oscillator section of this condenser has one less rotor plate than the detector section in order to make tracking easier over the amateur bands.

Lining up a superheterodyne receiver is always a problem unless a modulated test oscillator is available. It can be done by using signal noise level if the front end of the set is working properly. The IF transformers can be tuned until the noise level or some commercial signal is loudest. A far more satisfactory method is to use an oscillator to line up the IF. Use the harmonics of the oscillator to line up the front end of the set. The oscillator should first be capacitatively coupled to the grid of the IF tube, and the second IF transformer tuned for maximum signal in the telephone receivers. As these circuits are brought into line, less coupling can be used to the modulated oscillator. After the second IF transformer is tuned

properly, the oscillator should be capacitatively coupled to the grid of the detector. This is best done by disconnecting the detector coil grid clip and running the grid to ground through any resistor of from 200 to 10,000 ohms. The oscillator should be coupled directly to the grid through a small capacity, such as a twist of wire, unless there is an attenuator built into the oscillator. The resistor acts as an impedance to the IF signal and thus the detector acts as an IF amplifier, and the plate coil as well as the grid coil of the first IF transformer can be properly aligned. It is desirable to have the RF volume control set at maximum during these tests.

After the IF amplifier is properly aligned, harmonics of the oscillator can be used to align the front end of the set. This alignment is done by properly adjusting the two band-setting condensers on the front panel so as to catch the high frequency end of each amateur band at the low capacity end of the 2-gang tuning condenser. When the coil inductances are just right, the detector band-setter will not have to be adjusted as the main dial is tuned across the amateur bands (with the exception of the 160-meter band). These coil inductances can be varied by sliding turns along the coil forms before cementing them into place with Duco cement.

Each signal will have two points on the oscillator band-setter, and in every case the high frequency one should be chosen. First detector regeneration should always be used below the oscillating point. If this tube or the RF tube oscillates, spurious signals will usually be heard which are heterodyned into the IF amplifier.

Adjustment of the BFO knob is simple. The knob is set for about 1000-cycle beat note on a carrier signal which has been tuned in with the switch on phone position. The amount of BFO coupling to the second detector can be easily adjusted by adding or subtracting a capacitatively coupling turn around the grid lead to the second detector. One turn wrapped around this lead, from the oscillator plate, seems to be sufficient for most signals. In this set the BFO frequency is adjusted by means of a knob on the coil shield inside of the receiver.

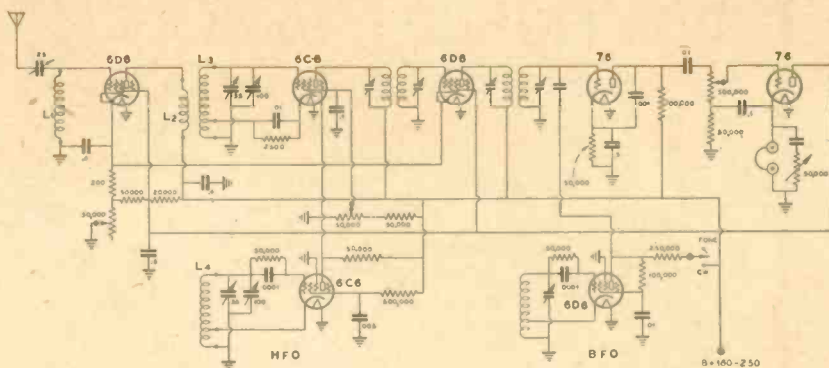

Circuit diagram of the 222 Receiver with RF stage. Data for L1, L2, L3 and L4 given in table below.

Coil Winding Table for Frank C. Jones' 222 Communications Receiver With R.F. Stage				
	L1 (R.F. Grid Coil)	L2 (Plate Winding)	L3 (Detector Coil)	L4 (Oscillator Coil)
For 10 Meters	20 Turns No. 18 DCC Wire. Winding space 1 inch long on a 7/8 inch dia. tube.	3 Turns No. 36 DSC Wire, interwound with L3.	4 1/4 Turns No. 22 DSC Wire, space wound to cover a winding space 1 inch long on a 1 1/2 inch dia. coil form. Tapped at 1/2 turn.	4 Turns No. 22 DSC wire, space wound to cover a winding space 1 inch long on a 1 1/2 inch dia. coil form. Tapped at 1 1/4 turns.
For 20 Meters	35 Turns No. 22 DSC Wire. Winding space 1 inch long on a 7/8 inch dia. tube.	7 Turns No. 36 DSC Wire, interwound with L3.	10 Turns No. 22 DSC Wire, space wound to cover a winding space 1 inch long on a 1 1/2 inch dia. coil form. Tapped at 1/2 turn. . . .	8 3/4 Turns No. 22 DSC wire, space wound over a winding space 1 inch long on a 1 1/2 inch dia. coil form. Tapped at 2 1/4 turns.
For 40 Meters	60 Turns No. 26 Enameled Wire. Winding space 1 inch long on a 7/8 inch dia. tube.	7 Turns No. 36 DSC Wire, interwound with L3.	10 Turns No. 22 DSC Wire, space wound to cover a winding space of 2 inches long on a 1 1/2 inch dia. coil form. Tapped at 1/2 turn.	8 3/4 Turns No. 22 DSC Wire, space wound to cover a winding space 1 inch long on a 1 1/2 inch dia. coil form. Tapped at 2 1/4 turns.
For 80 Meters	160 Turns No. 36 DSC Wire. Scramble wound on a 7/8 inch dia. tube, 1 in. long.	16 Turns No. 36 DSC Wire, interwound with L3.	30 Turns No. 22 DSC Wire over a winding space of 1 3/4 inches long on a 1 1/2 inch dia. coil form. Tapped at 3/4 turn.	26 3/4 Turns No. 22 DSC wire over a winding space of 1 3/4 inches long on a 1 1/2 inch dia. coil form. Tapped at 4 1/4 turns.
For 160 Meters	300 Turns No. 36 DSC Wire. Scramble wound on a 7/8 inch dia. tube, 1 in. long.	30 Turns No. 36 DSC Wire, interwound with L3.	60 Turns No. 28 DSC Wire over a winding space of 1 1/2 inches long on a 1 1/2 inch dia. coil form. Tapped at 1 1/4 turns.	53 Turns No. 28 DSC wire over a winding space of 1 1/2 inches long on a 1 1/2 inch dia. coil form. Tapped at 7 turns.

CALLS HEARD

Calls Heard at W2ESK

180 West 135th St., New York, N. Y. Room 302
Jan. 3 to Feb. 8, 1935
(Ann on 7 MC)

VK2ED, VK2RX, VK2IF, VK2DA, VK2EL, VK2LA, VK2YO, VK2OJ, VK2UP, VK3EG, VK3OV, VK3UH, VK3PV, VK3NP, VK3DZ, VK4AP, VK4CK, VK4EM, VK5LB, VK5LP, VK5LX, VK5GJ, VK5BK, VK6GW, VK6LY, VK6MA, VK7JB, VK7CU, EA1EA, EA3EG, EA4AV, EA4AO, EA4VB, EA5LB, EA7AO, EA7BC, EA7BE, EA8AE, F3CM, F8AG, F8EX, F8EO, F8PZ, F8PQ, FXFM4AA, CT1AZ, CT1AZ, CT1CB, CT1HO, CT1ZZ, CT2ZC, CT2AZ, CT3TM, LU2JE, LU2EG, CU2XF, LU3BB, LU4DC, LU5BL, LU6JB, LU7UZ, LU9BV, K4RJ, K4AF, K4BRN, K5AA, K5AM, K5AC, K5AI, K5AC, K6EWQ, K5CFQ, K7DC, KA1CS, KN3X, E1BB, Z1TR, ZS1Z, ZS6AM, U1USK, AC8ASR, XU2ES, XU3ST, ON4LJ, ON4JB, CE5AA, D4BBU, D4BBR, G2BM, G2DO, G6VP, G5ZX, Z11LI, Z12JM, Z12NT, Z13GM, Z13AN, X1AY, X1DC, X1DV, X2BX, X2BC, X2N, X5AY.

Overload Protective Device By W6GEA

As a safeguard against tube overloads and to prevent damage to other equipment in radio transmitters, the device shown in the illustration has been used successfully at station W6GEA. The system is indeed a simple one, has no intricate mechanical holding devices nor springs.

A Cutler-Hammer No. 600 relay is used for the normal open circuit, (A), another for the normal closed circuit, (B). E, E1 are the special holding-coil contacts.

The winding (L1) is in series with the TOTAL negative plate current. It consists of 1500 turns of No. 30 B.S.G. Enameled wire, and is tapped

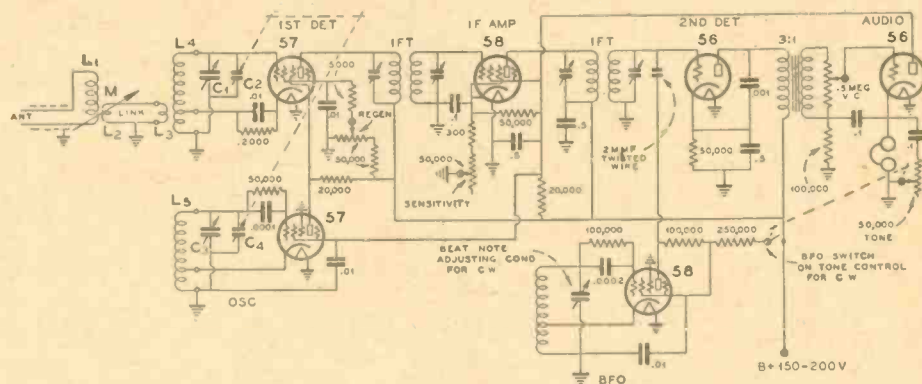

THE ORIGINAL FRANK C. JONES' 222 COMMUNICATIONS RECEIVER

This is the circuit of the original 222 Receiver WITHOUT RF stage. The circuit as published in January "RADIO" was not correct in that there was no plate voltage connection to the oscillator tube.

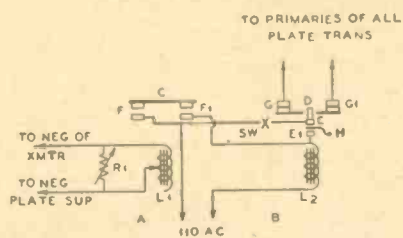

at 500, 750, and 1000 turns. Finer adjustment is made with the variable resistance (R1) which shunts the coil (L1). The winding (L2) is for

normal 110 volt AC operation, causing the break in the primary of all plate transformers, and is also the holding coil.

For example, let us assume that the final stage starts drawing excess current, which may be due to many reasons. The additional current in (L1) would attract the armature (C), completing the circuit through (L2) which breaks the primary of all power transformers, formerly completed through contacts (G, G1); if it were not for the holding contacts (E, E1) the process would perpetually run on and off.

After the plate power is off, the holding relay will run until the normal closed switch (Sw) is opened for a moment. (H) is a contact spring to prevent "bumping" of the armature (D).

This relay will quickly pay for itself, and should be considered an integral part of every transmitter. The circuit is self-explanatory.

Disturbances in Radio Transmission

By A. M. SKELLETT

Radio Research, Bell Telephone Laboratories

ALL radio waves which traverse long distances over the earth's surface make use of the upper atmosphere. Indeed were it not for the electrical properties of these high regions*, by reason of which the waves are bent back toward the earth, radio transmission over distances greater than a thousand miles or so would be impossible. Short waves, at least, would simply pass out into space instead of following the curvature of the earth.

These electrical properties are due to the

ionization of the ionosphere being responsible for the major effects. The latter deviations appear to be of two kinds, a general increase in the amount of ionization and an increase in the turbulence. In the daytime the resultant effects on radio transmission vary greatly with the wave length: long distance transmission by long waves (5,000 meters or more) is better, but transmission by short waves (10 to 100 meters) may be severely disturbed or completely wiped out. During the night hours, the effect on the

short waves is of the same kind as in the daytime, whereas the long waves experience a relatively mild depression in the strength of the received signals.

Apparently the general increase in ionization during disturbed periods enhances the "reflecting power" of the ionosphere for long waves during the day, while an opposite effect is produced on short waves. It appears that the layer of ionization which is intensified by the disturbance acts both as a reflector for the long waves and as absorber for the short, so that the increase in ionization affects the two ranges of frequency oppositely. These facts imply that the short waves are reflected at a higher level than the long, and such is known to be the case.

The study of magnetic storms has furnished strong evidence that the fundamental cause of these various phenomena is to be found in the sun. This is indicated by the appearance, in the magnetic records, of the two major solar periods; the eleven-year period of sun spots and most other forms of solar activity (Fig. 1), and the approximate twenty-seven-day period of the sun's rotation. There are now also enough radio data to show this twenty-seven-day period. In Fig. 4 the size of a dot on the radio chart corresponds, roughly, to the relative intensity

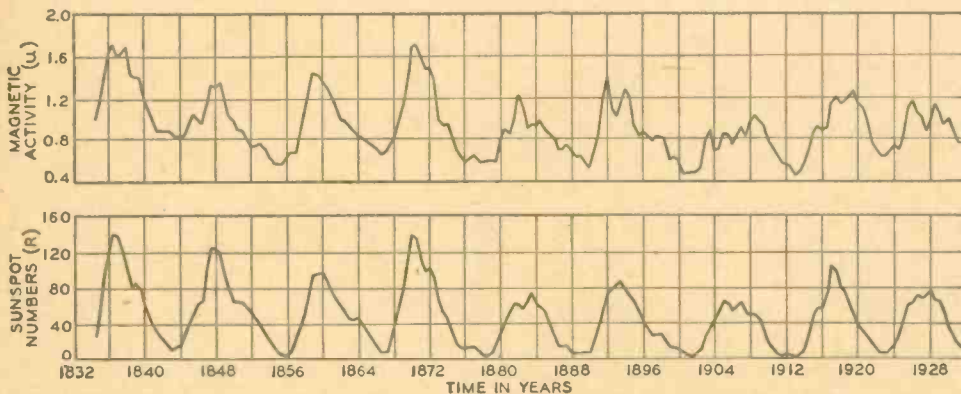

FIG. 1.—Magnetic and sun spot data show an eleven-year period of variation. These data were compiled by the Department of Terrestrial Magnetism of the Carnegie Institution of Washington.

ionization of the gases; that is, the breaking up of the atoms and molecules into electrons and ions by ionizing agents. It is believed that the most important of these agencies is the ultra-violet light from the sun. Others which are believed to contribute to the ionization are the ultra-violet light from the stars, cosmic rays, meteors, and electrons, ions or neutral particles from the sun. None of these, except possibly cosmic rays, acts in a steady continuous manner, and in consequence the electrical state of the ionosphere varies continually. Some of these variations are fairly regular and give rise to disturbances in long distance radio transmission.

One type of such disturbance occurs at the time of a "magnetic storm," and is very detrimental to short waves traveling over high-latitude paths. In fact, radio pulse experiments have shown that the ionosphere in polar regions completely absorbs short waves at such times. Coincident with the magnetic and radio effects other phenomena are observed, the most prominent of which are the abnormal electric currents in the earth's crust and the appearance of the aurora in unusually low latitudes. Since the magnetic aspect of these disturbances has received by far the greatest amount of study, the term magnetic storm is used in the discussion of any of these phenomena.

Theoretical considerations indicate that the variations of the earth's magnetic field have only a minor effect on radio transmission in general, the changes in the

* The atmosphere may be divided into four parts: (1) the troposphere, extending to a height of about 7 miles; (2) the stratosphere or "isothermal region" from 7 miles to about 25 miles; (3) the ozonosphere from about 25 to about 45 miles and (4) the ionosphere above about 45 miles. The ionosphere is the region which is important in radio transmission.

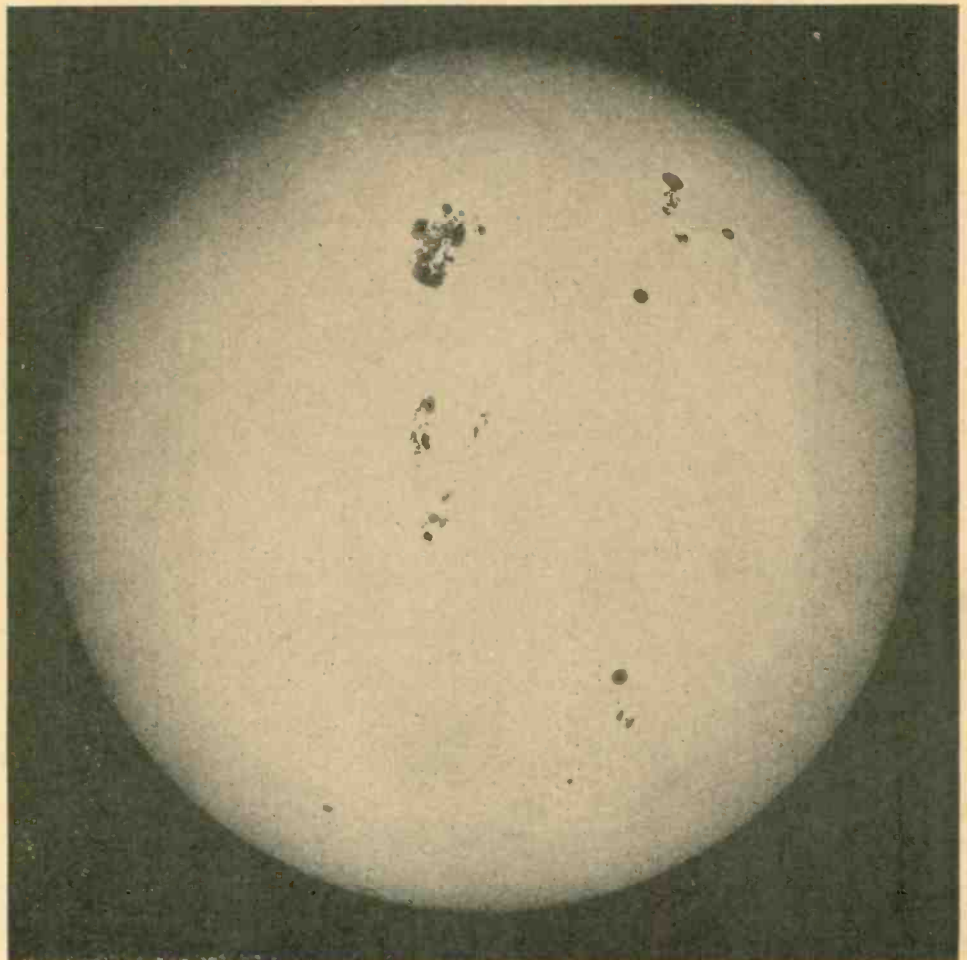

FIG. 2.—This photoheliogram, taken by Ellerman at Mount Wilson Observatory, shows several sun spots.

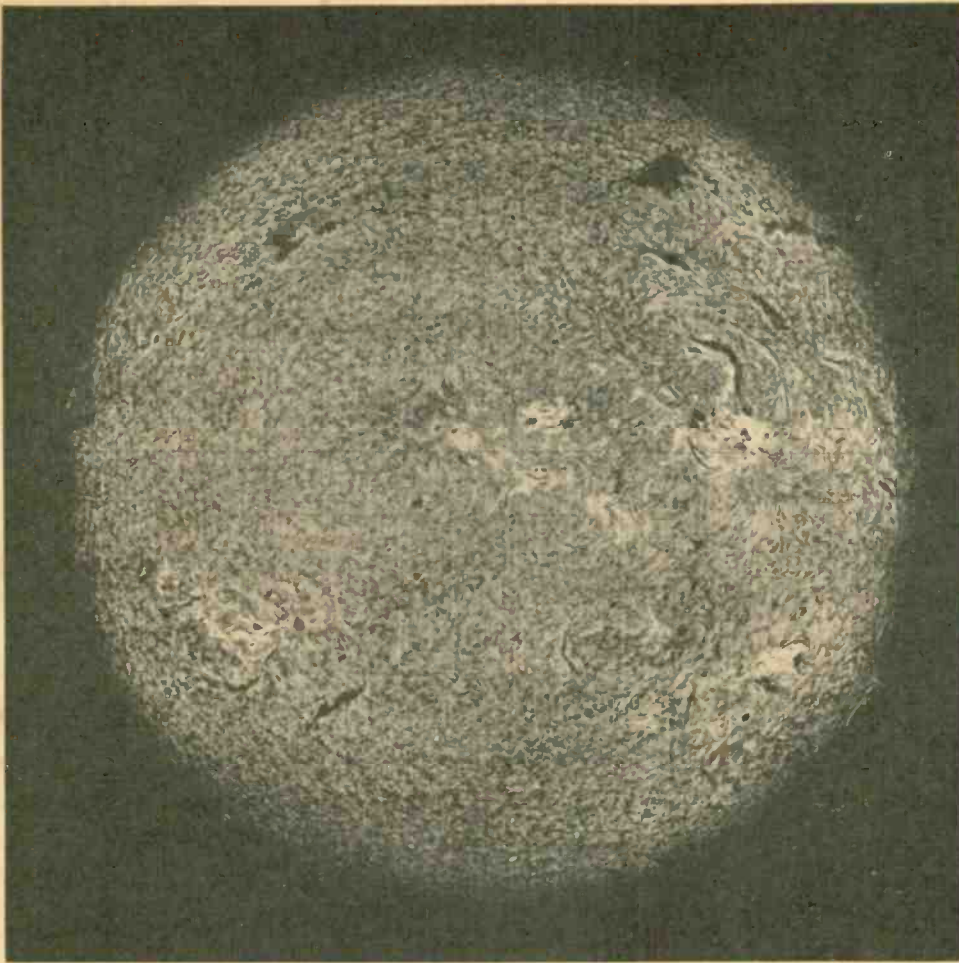

FIG. 3—This spectroheliogram (in the H α line) showing flocculi was taken at Mount Wilson at about the same time as Fig. 2.

from day to day of the disturbances of the short-wave telephone circuits between New York and London. The tendency for these to recur time after time at intervals of approximately twenty-seven days is apparent. There are also enough data on the long waves to show an eleven-year period of variation over more than one solar cycle.

At the time of each of the nineteen great magnetic storms that occurred from 1875 to 1903, E. W. Maunder, an English astronomer, found that there was a large sun spot on the visible side of the sun. For storms of lesser magnitude the relation did not always hold. Magnetic disturbances sometimes occur when no spots are visible on the sun, and large spots are at times observed when no disturbances occur. Evidently the cause of the terrestrial disturbances must be sought further.

An instrument which makes such a study possible is the spectrohelioscope, which discloses phenomena entirely invisible in the ordinary telescope. As its name implies, it enables one to observe the sun in the light of any particular wavelength in the solar spectrum. If the instrument is set for one of the absorption lines of hydrogen, the distribution of this element over the solar surface may be seen. In this light the appearance of the sun is strikingly different from that given by white light (Fig. 2). The granular structure is much coarser, and clouds of hydrogen are usually seen over the surface, while around the edge such clouds may often be observed as prominences or ruddily hued flames projecting out from the sun.

The prominences are sometimes seen to

blow off into space with great velocities (Fig. 5), and such observations strongly suggest a mechanism by which a disturbance may be transmitted from the sun to the earth. A number of bright eruptions have been ob-

served to occur on the solar surface, usually near large spots, which were followed by magnetic storms on the earth after an average interval of about twenty-six hours. Theoretical considerations indicate that the speed of a particle ejected from the sun by radiation pressure would be a thousand miles per second, at which velocity the particle would take twenty-six hours to traverse the 93,000,000 miles from the sun to the earth. The conditions are not as simple as this would imply, however, and recent studies of the motions of prominences cast some doubt on the generally accepted importance of the role which is played by radiation pressure in ejecting them.

Regarding the means by which the disturbance is transmitted between the sun and the earth, it appears likely that the actual carriers are electrons or ions or a combination of both. The fact that the disturbance on the sun can be seen before electrical effects are experienced on the earth, implies a carrier other than light. Moreover, the form and position of the aurora produced at such times have been reproduced in the laboratory by bombarding a magnetized iron sphere with electrons.

One may picture the origin of a magnetic storm in this way. First a solar eruption emits a stream of electrons and possibly ions into space; then some time later these charged corpuscles arrive at the earth and are so guided by its magnetic field that most of them enter the atmosphere around the polar regions. As they strike the outer atmosphere they ionize and disturb it, and as a direct result radio transmission through these regions is poor and a brilliant aurora appears. It has been suggested that electric currents would be set up in these high regions which would give rise to the magnetic and electrical effects observed at the earth's surface.

The durations of these great solar eruptions are very brief, astronomically speaking, usually a matter of hours or less, and since the sun can be observed only intermittently, the record of their appearance is necessarily

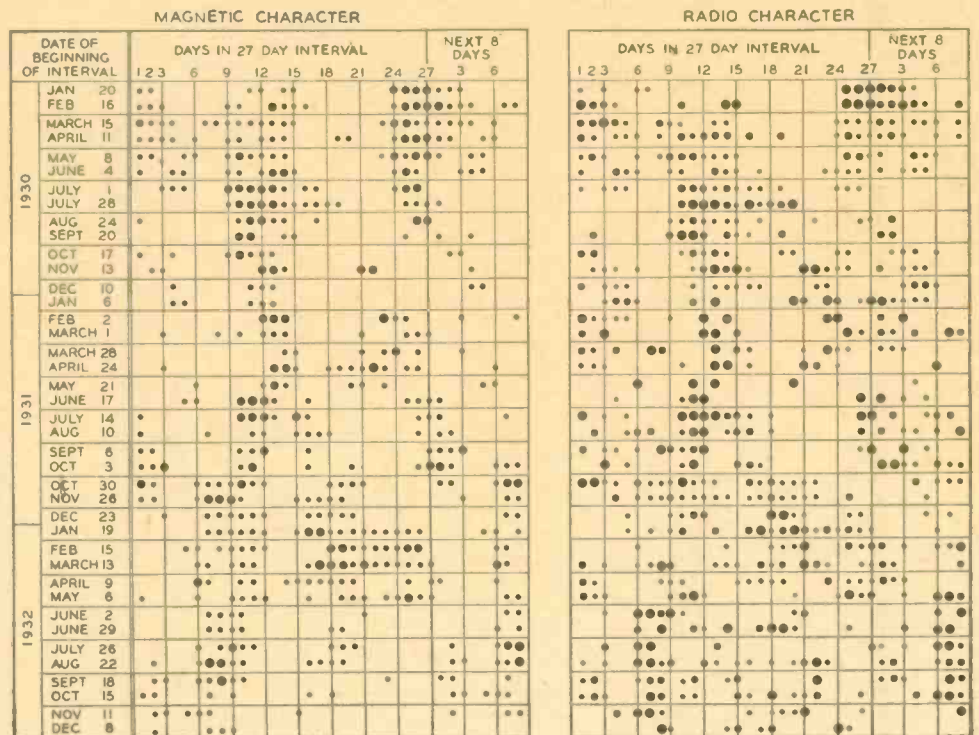

FIG. 4—Both magnetic and radio data show a twenty-seven-day period of variation.

very incomplete. It is probably significant that almost all of those observed have been followed by intense magnetic storms. At times long distance transmission is disturbed when there is no magnetic storm. The question naturally arises: are there other means by which the normal behavior of the ionosphere may be altered. Is it possible, for example, that the haphazard bombardment of the upper atmosphere by meteors is one such cause of disturbance?

The average shooting star has a velocity many times that of the fastest rifle bullet. When it strikes an atmospheric molecule, the energy of impact is great enough to break up the molecule into ions and electrons. Often a bright meteor will leave a glowing train which floats in the upper atmosphere for some time after the meteor has disappeared and which may be a mile or more in diameter. It seems likely that such night-time trains are one of the phenomena accompanying ionization. They seem to occur exclusively in the lower layer of the ionosphere.

More direct proof of meteoric ionization was obtained at the Laboratories at Deal during the Leonid meteor shower of 1932. Measurements of ionization by the radio pulse method indicated increases in ionization directly overhead coincident with the passage of bright meteors through this region. For the brightest observed, the ionization increased by an amount in excess of that which is found at noon in summer. These observations, as well as others made by J. P. Schafer and W. M. Goodall during other meteor showers, furnish direct evidence of the ionizing effects of visible meteors in the lower layer of the ionosphere.

A conservative estimate of the number of meteors which hit the atmosphere each day is one billion, averaging about five per square mile of the earth's surface. If each meteor spreads ionization around its path to a distance of a fraction of a mile, a radio beam which travels a long distance through the ionosphere will be subjected at normal times to a continuous bombardment. This brings up a question which has not as yet been answered: does this bombardment produce sufficient turbulence to cause fading?

It is in the general region of the lower layer, fifty to seventy-five miles above the earth, and in that neighboring to it, that most of the shooting stars observed by the naked eye are seen. The telescope, however, reveals many more whose paths apparently

lie in or near the region of the upper layer (175 to 190 miles high). These are much more difficult to observe since they are much fainter and traverse the field of the telescope in a very small fraction of a second. It is

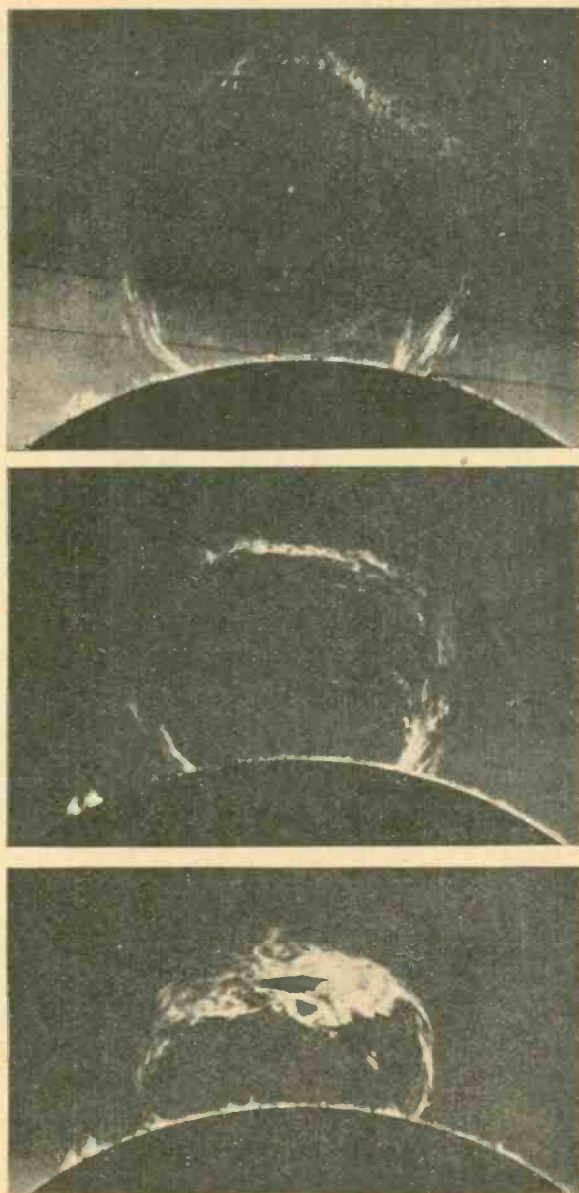

FIG. 5—These spectroheliograms show three successive stages of a prominence blowing off the sun. The time interval between 1 and 2 is about forty-four minutes, and between 2 and 3 about fifteen minutes. The pictures were taken by Pettit at the Yerkes Observatory.

not unlikely, therefore, that the upper layer may experience meteor showers which are never seen. Whether or not they are the cause of unexplained interruptions of long distance transmission cannot be determined from present data, but that they constitute a possible source of such disturbances as these is evident.

CALLS HEARD

Calls Heard at W3OP, Allentown, Pa.

Jan. 15, to Feb. 15, 1935, on 7 MC
 CN8SEG, CT1AG, CT1BQ, CT1ED, CT1ET, CT1OI, CT1KN, CT1KR, CT1JW, D4BJL, D4BKU, D4BUB, D4BWM, EA1AM, EA4AP, EA4BF, EA4B, EA5BG, EA5BS, EA5BM, EA5BA, EA6AM, EA7BD, EA8AG, F8GV, F8JI, F8JJ, F8TQ, F8EO, F8GS, F8RI, F8IM, F8TM, FM3FB, FM8CR, FM8JO, FM8PW, G2FM, G2MV, G5CW, G5FN, G5YV, G6NJ, G6CT, G6VP, G6OX, G6RH, G6NF, G6KU, G6WY, HB9J, MC1FS, HC2HP, HP1A, LU2EG, LU2EN, LU2RC, LU5BL, OK1PK, OK2LK, PA0IR, PA0XF, ON4AU, ON4MT, ON4ZA, ON4ZQ, PK1BO, PK1BO, PY1AW, TI2TF, VQ4CRH, VQ4CRL, VK2HF, VK2QP, VK2YO, VK3XW, VK3XQ, VK3FB, VK7HL, VP4JL, VP4AA, ZL1DI, ZUID, HJD2.

Calls Heard at W1FET

14 MC—Oct. 31 to Dec. 31, 1934
 CM6AW, CX1CX, F8SMI, FC4CJJ, FM8BG, HAF8D, HC1JW, HI7G (fone), HP1A, J2GX, K4BTL, K4KD, K5AA, K6AC, K6HLP, LA3R, LA4U, LU5FV, LU6AP, LY1J, NY1AB, OE3FL, ON4CSL, ON4CJJ, PY1AW, SP1DE, SP1CO, SU1EC, SU1SG, TI2TAO, TI3WD, VK3MR, VP2AT, VP4AA, VP4JR, VP5AB, VP5AC, VP5JB, VP5PZ, VQ4CRL, VQ4CRP, VQ8A, X1AG, X1AM, X1AY, X1BB, X1D, X1DC, X1Y, ZE1JF, ZE1JJ, ZS1D, ZS1H, ZS1P, ZS2A, ZS2J, ZS4U, ZS6M, ZS6V, ZT1H, ZT1R, ZT1Z, ZT2F, ZT6A, ZT6J, ZT6N, ZU6P.

7 MC—Oct. 31 to Dec. 31
 CM2AD, CM2AF, CM2DO, CM2FA, CM2FC, CM2IP, CM2NA, CM2MG, CM7CX, CM7JP, CM8PQ, CN8MR, CN8ALC, CT1AA, CT1BG, CT1CB, CT1CC, CT1ED, CT1FI, CT1JW, CT1KR, CT1LZ, CT1ZZ, CT2BK, D4BBT, D4BFH, D4BGK, D4BHH, D4BKU, D4BLU, D4BNN, D4LBV, EA1AE, ET1AN, EA1AR, EA1BA, EA2AD, EA3AN, EA3EG, EA4AO, EA5BS, EA7AH, EA7BC, EA7BE, EA8AF, EA8AH, EI8B, F3CX, F3DM, F3FY, F8EO, F8JJ, F8PLM, F8WO, F8ZE, F8ZF, FM3JZ, FM4AB, G2AO, G2DU, G2IC, G2NM, G2TR, G2VV, G5BJ, G5CV, G5FN, G5HC, G5LI, G5PJ, G5WP, G5US, G5YV, G6GM, G6IY, G6KP, G6NJ, G6RS, G6TM, G6UF, G6US, G6RV, G6VK, G6WY, G6XB, G6YL, G15MZ, G16TK, HB9A0, K5AA, K5AF, K5AG, K5AM, LU1AB, LU7AZ, NY1AA, NY1AB, NY2AB, OE7JH, OK1CB, OK1FF, OK1JC, OK1LN, OK2MS, ON4AP, ON4AU, ON4CJJ, ON4DS, ON4FE, ON4GRX, ON4GU, ON4GW, ON4PA, ON4VC, PA0ASD, PA0DC, PA0HG, PA0LR, PA0MR, PA0QL, PA0YG, PA0ZM, PA0ZP, PY1AW, SP1AR, SP1DB, SP1HN, SP1KX, TI2RU, U3EN, VK2OA, VK2FD, VK2KJ, VK2KM, VK2OJ, VK2SK, VK2XJ, VK2YO, VK3MR, VK3YU, VK3XQ, VK3ZF, VK4KY, VK4RY, VK5HG, VK5MH, VK5WG, VK5XU, VO8Y, VP5PA, X1AX, X1D, X1DA, X2C, X2N, XZ2NC, YR5AA, ZL2BZ, ZL4CK, ZS6AM, ZU6B.

Calls Heard at W9SOW

Jan. 1, 1935, to Feb. 12, 1935
 Chas. B. Kindred, (EX9FDJ) Atlanta, Ill.
 14,000 KC
 AX7RH, CM2IP, CM5JD, CM6AA, CM8PQ, CX1FB, CX2AM, F3MTA, F3SMI, F8WK, HJ3AJH, HP1A, K5AA, K6AC, K6AN, K5AT, K5AY, K7DVF, K7DVF, LU5AQ, LU5EW, LU5FV, LU7EF, NY1AA, NY1AB, OA4AA, OA4J, ON4AU, ON4CJJ, ON4CSL, PY1AW, PY9AD, VO4Y, VO4Z, VP2AT, VP4AA, VP4FH, VP4JR, VP5AB, VP5AC, VP5PZ, VQ4CRP, X1AM, X1AX, X2H, ZD2C, ZE1JB, ZE1JJ, ZE1JN, ZS6AL, ZS6V.

7,000 KC
 CE3EL, CE5AA, CM2AS, CM2DO, CM2OP, CM2ZN, CM6CR, CM6DW, CX1BU, EA3EG, EA4AO, EA7BE, EA8AH, J2CL, K5AA, K5AC, K5AF, K5AG, K5AM, K5AY, K6EWO, K6GQF, K6HLP, K6JPT, K6KVX, K6MV, LU1AB, LU1JH, LU7AZ, NY2AB, OM1TB, OM2AA, OM2RX, PY1AW, VP4JL, VK2DA, VK2FK, VK2OJ, VK2YL, VK3AX, VK3BG, VK3FG, VK3ZB, VK5GL, VK6SA, VK7XL, X1CM, X1DC, X1FQ, X2A, X2BJ, X2V, ZL1AO, ZL1AR, ZL2CI, ZL2CY, ZL2FN, ZL2JA, ZL2LT, ZL2NC, ZL3AN, ZL3CM, ZL3FG, ZS1Z, ZS2A, ZT1H.

Calls Heard By W8DVS, Ambridge, Penn.

Between November 15 and December 6
 Worked Heard
 8C CN8MP
 HB9N G16TK
 HJ3AJH HAF8D
 J2HG J2GX
 ON4CUU K7ZZK
 ON4LX KX3
 SP1CO LA4U
 VQ3BAL OH8NB
 ZE1JF SP1LM
 ZS1C U1BL
 ZS2A VQ8A
 ZS6AA ZE1JJ
 ZT6A ZS1H
 ZT6N ZS4U
 ZU1X ZS6M
 ZU6M ZT1Z

★ Special Announcement —

A new Beat-Frequency Oscillator and An Improved Crystal Filter Circuit for Superheterodyne receivers will be described in detail in April "RADIO" by Frank C. Jones. These new developments can be incorporated in any receiver and will be of material aid in better reception. April "RADIO" will be of an unusually-high technical standard. Why not send \$1.00 now for a 4-month subscription?

Amateur News

IRF Rehabilitation Plan

● The first of these plans was announced last month. Briefly, it consists of educating our law makers as to what amateur radio is and the true function of the amateur; this to be accomplished by actual demonstration of representative good amateur stations and operators which IRF is equipped to provide. Amateur phone will be used to a great extent in this program.

Movements as great as this one cannot be duplicated in a proverbial day. It takes time and often too-rapid progress is detrimental. With this in mind, the coming year of IRF will undoubtedly see a strengthening of the lines and a perfecting of the great plan it has conceived. It does not seem unreasonable to be most optimistic as to the future of IRF and its promulgation of the New Deal in amateur radio. Whether amateur radio is bettered and greatly improved directly, by the IRF plan, or causes others to accomplish the same purpose, makes little difference. As long as amateur radio is restored to its place in the sun, those who conceived the plan will feel that their work was not in vain.

IRF Contest

● A contest for the largest number of IRF QSO's will be in effect during the third week of April, starting April 14th, Sunday, 10:00 a.m. PST, and finishing April 21st, Sunday, 10:00 p.m. PST. All IRF men are urged to participate in the contest, in order to show the radio world that IRF is a strong fraternity and world wide. At the conclusion of the contest, contestants will send in their list of QSO's to IRF headquarters, this list to be copied out of the log, showing time, call, report, etc. Messages are unnecessary. A substantial prize will be awarded the winner as soon as the lists are judged. IRF men will be sent further notice of the contest.

The Mike and Key Club, Elyria, Ohio

The Fourth Annual Hamfest sponsored by the Mike and Key Club is to be held Sunday, February 24th, at the Masonic Auditorium in Lorain, Ohio.

Reservations are being made by radio amateurs from all sections of Northern Ohio, and present indications are that the attendance will reach two hundred, excluding the speakers and entertainers.

Second Annual "Ham Fest"

The Second Annual Ham Dance and Entertainment sponsored by the Mid-West Mart will be held in the Congress Hotel, Saturday evening, March 30th, and all indications point to a record crowd. Master of Ceremonies will be John O'Hara, well known amateur and station announcer.

David E. Day has arranged a most complete program including a very entertaining stage show. Prizes amounting to over \$5,000 will be given to the holders of the lucky tickets.

A special prize will be awarded to the "Ham" coming from the most distant point.

Here is an opportunity to meet all the QSLs you have made, but have never met personally.

Prizes have been donated by the following: Arvofox, Arcturus, Biley, Allen D. Cardwell, Centralab, Cornell Dubiller, Raytheon, Electrad, Carter Motor Co., Hygrade Sylvania, Lenz Electric, Lynch Mfg. Co., Magnavox, McMurdo Silver, Ohmite, Radio, Crowe Name Plate, Sangamo, Thordarson, Burgess Battery, Continental Carbon, Universal Microphone, General Mfg. Co., Yaxley Mfg. Co., and many others.

Your local club can get full particulars by writing to the Mid-West Radio Mart of 520 S. State St., Chicago.

DX News

Feb. 14, 1935.

Editor, "RADIO"
Pacific Building,
San Francisco, California.

Dear OM:
Have a little DX news which may be of interest to you.

On February 12, 1935, I had the extraordinarily rare good luck to work Australia, South Africa, and Japan within a period of three hours. This was done on 14 MC, in the late afternoon. It is believed that this is somewhat of a record for these parts, speaking of the first and second districts. Districts to the west and to the south of the second are, of course, not affected by quite the same adverse conditions as are the first and second districts.

As you know Asia is our greatest stumbling block. Even to hear an Asian was something to talk about until a short time ago. It was only about a year and a half ago that any South Africans could be heard on 14 MC. Although Australia is easily worked on 7 MC, VK signals on 14 MC are about as rare as J's. Only a few have been heard at this station in several years, and then only in the early morning.

Conditions have changed greatly in the last two years. Now it is no trouble at all to work South Africans in the afternoon hours, on 14 MC. Lately J2HG, on 14 MC, has been coming in here almost every evening around 5:30 p.m., EST, with fair strength. He is generally good for only about 20 minutes or a half hour, but when conditions are exceptional he stays in for periods up to an hour and a half. Although we have no schedule I have been able to work him with fair regularity.

At 3 o'clock on the afternoon of Feb. 12, I was quite surprised to hear VK4GK calling "CQ". I had just turned on my receiver. I got him on the first call. He was quite strong, and was still coming in good over an hour after I worked him. Got him at 3:11. ZS6AL came next, at 4:43, and then J2HG, at 6:07. I think it very rarely happens that these widely separated countries come in here at the same time on 14 MC, and it is even more rare to have the good luck to hook them. Hi! Best wishes, 73.

Sincerely yours,
Arthur M. Braaten, W2BSR.

Macon's Radio Man Is Lauded In Senate

"Greater Love Hath No Man Than This . . ."

The affairs of government were cast aside on Capitol Hill in Washington as solemn visaged senators heard the story of a man who laid down his life for his friends.

The story of Ernest E. Dailey, radio operator, who, by his cool headed heroism, saved the lives of eighty-one officers and men when the Macon crashed into the sea off Point Sur, become, for a time, more important than all the politics and problems of the nation.

Johnson Speaks

The story was told when Senator Hiram Johnson asked Congress to insure the future of the widow of the heroic radioman. Senator Johnson introduced a bill to pay a pension of \$100 per month to Mrs. Dailey instead of the \$20 which she would receive under present regulations.

"Radioman Dailey," Senator Johnson declared, "met his death heroically in the performance of his duty and his widow should not be left in need."

Behind the story of Radioman Dailey is a story of wifely fortitude which is blazoned across the history of the naval service.

Tuesday Night

It is the night of Tuesday, February 12. At Sunnyvale the wives and sisters of the members of the crew are awaiting the return of the queen of the skies from maneuvers at sea with the fleet.

Suddenly, out of the dusk, comes a calm message from the Macon. It is brief, terse, but it is filled with tragedy. "Falling", it said. The message was being calmly transmitted on the Macon's radio by Radioman Dailey.

A moment later there is another message, like the first calm, terse, but complete, giving the exact position of the giant dirigible. The women of the air base rush to headquarters, among them Mrs. Dailey, an expectant mother.

Wives Talked

She converses with the other wives. They are told of conversation between officials of the naval district here and Admiral J. M. Reeves with the fleet. There is a hopeful message and they are buoyed up in spirit. Only two men have been lost.

Then, laboriously, comes the message containing the names of the survivors. Eagerly, Mrs. Dailey and the other wives scan the list. Then—tragedy for this wife. The name of her husband is not included among those saved. It was more than she could stand and she collapsed.

It was not until the next day that she learned of the great heroism of her husband. He had stuck to his post sending the Macon's position until it was too late to save himself and he had leaped into the water. In the plunge he turned over and struck on his back, breaking it.

Only last fall had she become the bride of Radioman Dailey. The future was dark for her. His pay had been small, for he was but an enlisted man.

That is the story which lay behind the action of Senator Johnson in the Senate. The future of a hero's wife must be insured.

—A.P.

Stockton Hamfest Writes New Chapter In Amateur Radio History

The officers and members of the Stockton Amateur Radio Club of Stockton, California, goes the credit for conducting one of amateur radio's most lively and colorful hamfests.

It was the first of California's "free lance" hamfests, having no affiliation with any national amateur radio organization. Thus the political meeting was thrown open to all, and a red-hot debate was staged. No words were minced in telling the amateurs what must be done to safeguard their interests at Cairo. A plan was suggested for united effort by other free-thinking amateur

radio clubs throughout the nation so that the unorganized majority can play an important part in the protection of amateur privileges. The Stockton Club welcomes communications from other groups of radio amateurs who are seriously interested in joining the great drive to carry the plight of the radio amateur to the floor of Congress.

Wild enthusiasm was displayed when Pacific Division's Director Culver scored interference by foreign powers with American amateur radio privileges. He called upon the American radio amateur to do his part to help make his own air a safe place in which to operate.

Highlights of the Hamfest

Largest attendance of any similar affair staged in a remotely-located city. Banquet hall filled to overflowing.

Out-of-state visitors.

Naughty burlesque show.

Blushing YLs and YFs who got an orful earful.

Colonel Foster's reply to the "gentleman from Sacramento".

Frank C. Jones' announcement that a new BFO and crystal filter circuit will be shown next month.

Expression of delight on face of brand new ham who won HK-354 Gammatron.

Embarrassing position of publisher of "RADIO" when his ticket was drawn as winner of capital prize—complete National FBXA with speaker and accessories.

Sigh of relief by entire audience when publisher requested re-drawing for the prize.

Cruel twist of fate when same publisher draws another winning ticket later in the evening.

Sidelights

YL in the rear left corner who wrote down the jokes of the naughty comedian.

Jayenay's absence from the meeting because he heard that Jean Harlowe would be in Carmel on same night.

Look of disgust on Goodman's face when ham comedian swiped his favorite blindfold act.

Lack of invitations to take chorus girls home.

Calls Heard by W9FLM, W. A. Craig, Jan. 5 to Feb. 11, Prophetstown, Ill.

7 MC
CE3EL, EA1BB, EA3EG, EA4BM, EA8AE, F3AL, F8ZE, J2CL, J2GX, J2KA, J2KP, J2KS, J2LC, J2LO, J3FK, KA1SX, K6CGK, K6GQF, K6HLP, K6JPT, K6KTF, K6KVX, K6LBR, K6LEJ, K6MV, OM2AA, OM2RX, PY1(W), VK2NL, VK2NJ, VK2EL, VK2MY, VK3VL, VK3DM, VK3AX, VK3KX, VK6FO, ZS2A, ZS6AM, ZT1H, ZU6B.

14 MC
CT1BY, D4BAO, D4BHH, D4BBN, FB8O, F8WB, F2FC, F8RJ, F8EO, G2PL, G2RQ, G2BH, G2BY, G2DL, G2HG, G2SX, G5BY, G5BD, G5YH, G6SR, G6BS, G6PH, G6NJ, G6QP, G6QB, G6KP, G6NH, G6WU, G6RH, G15MZ, HJ3AJH, K7DFV, OK1FU, ON4CMY, ON4CSL, ON4HM, ON4CJJ, PA0LU, PA0LR, PA0CE, PA0FP, PA0WR, VP4JL, VQ4CRP, VQ4CRH, VQ8A, ZE2AZ, ZS6AL, ZS6M, ZU6E.

Calls Heard by W9PAO Dec. 12 to Feb. 15

7 MC
B4UP, HJDA, CM2FA, CM2OP, CM2DQ, CM8AA, CM2AS, CM2PW, VK2EO, VK2OJ, VK2HZ, VK2AO, VK2DA, VK2VQ, VK2XV, VK2AZ, VK2EL, VK2KN, VK2TA, VK2LA, VK2QO, VK2WU, VK3BG, VK3DP, VK3OL, VK3ZQ, VK3NQ, VK3GU, VK3BS, VK3XF, VK3MR, VK3U, VK4RN, VK4AP, KV6ML, VK6GL, VK6MI, VK6MN, VK6FO, VK7JB, VK7XL, X1CZ, X1D, X2O, X2T, X2F, X2L, Z2BG, K6LEJ, K6KVX, K6GQF, K6EWQ, K6KJP, K6KFB (W6) K5AA, K5AF, K5AM, K5AT, K5AY, NY1AB, KA1HR, OM1TB, LU7AZ, LU1ZA, LU6BL, LU6DJK, LU1DA, ZL4CK, ZL2DW, ZL3BS, ZL1DI, ZL2FR, ZL2NC, ZL3AN, ZL2LG, ZL4AI, ZL3FM, ZL3CU, K7ZZK, EA4AO, EA1BB, T2RC (FONE), PY1AW, CE5AA, CE3EL, ZU6P, ZU6B, Z5A, VP4JR, OA4O, D4CDA, J2LK, J2LO, HC1FG (FONE).

14 MC
ON4AL, ON4AU, G5YH, G2HG, G5TZ, G2BM, G2SX, G2HX, G6NB, G6AS, G2OA, VP4AA, VP6PZ, VP6AB, F8EO, YN1BX, CM2FL, K5AA, K5AG, K5AF, NY1AB, NY2AB, X1AM, X1W (FONE) H7G (FONE), OA4V, OA4U, ZS1H, S2GX, HJ3ABK, ON4CSL, VQ4CRP.

Calls Heard by G6ZU

R. H. Jackson, 54 Prince's St., Stockport, Cheshire, England.)

October to December, 1934.
W6ADP, W6BVX, W6BYU, W6BIP, W6CXW, W7JZL, W6GRX, W6HJT, W6LFL, W6RZ, W7AYQ.

The Lafayette B-46 Modulator Unit

A Companion Unit for the Model P-46 40-Watt Transmitter

By FRANK LESTER*

● The Lafayette Model P-46 30-watt transmitter, using the 2B6 exciter circuit and inexpensive parallel 46s in the output stage, as described in the previous issue, has already achieved popularity among amateurs because of its reliable electrical design and its simple, compact construction. Readers will recall that the circuit uses a 2B6 double-triode as crystal oscillator and buffer or doubler, 46 amplifier and parallel 46s in the final. The entire outfit, including power supply, is built into an attractive steel table style cabinet measuring 19 by 12 by 8 3/4 inches.

With the presentation of this transmitter came an immediate demand for a modulator unit for use on the 20, 75, and 160-meter phone bands. Accordingly, the same cabinet was used and several experimental circuits laid out for trial. The final layout, selected after thorough test in the laboratory and actual trial on the air, is shown in the accompanying diagram. The unit is known as the Lafayette Model B-46 Modulator.

Five tubes plus rectifier are used. The first is a 57 used as a high-gain pentode, resistance-

current for the tubes is provided by two low voltage windings on T4. The 83 rectifier, with its low internal voltage drop of only 15 volts, gives the power pack the good regulation necessary for class B service, with its widely varying current requirements.

The 57, the 56 and the first 46 receive their plate voltage through individual series dropping resistors, R5, R8 and R9 respectively. These also function as decoupling resistors and completely prevent coupling effects through the common power supply. The bypass condensers C1, C2, C6 and C7 chase the AF plate current components back to cathode or filament. These simple precautions give the entire amplifier a rock-bound stability that is reflected in its beautifully-clean operation.

Because crystal microphones are now relatively inexpensive and their quality and convenience make them ideal for amateur purposes, this modulator unit was designed for them. The mike is simply hooked across the input posts and that's all there's to it; no

messing with pre-amplifiers or anything else.

The overall gain of this modulator unit is 110 Db, with a hum level of minus 50 Db. The frequency response, as determined by test with the RCA beat frequency oscillator, is uniform to plus or minus 1 1/2 Db. from 60 to 17,000 cycles. While this is in excess of amateur requirements, it assures the user of absolutely perfect modulation in the voice frequency stage. "Broadcast quality", the goal of every phone ham, is easily achieved with this outfit.

The mechanical construction of the modulator unit is made clear in the accompanying photographs. The heavy audio units, transformers and chokes, are lined up along the back of the chassis, with the tubes in front. Note that the 57 is fitted with a shield to cut down external noise pick-up, which can be serious with a high-gain amplifier.

In the center of the front panel are the plate milliammeter and the gain control. On the left, the microphone jack; on the right, the line switch.

The electrical values of all parts are given in the accompanying table.

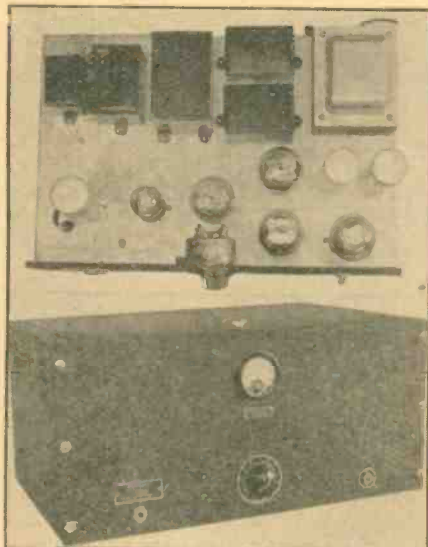

Interior and Exterior Views of the Modulator Unit

capacity coupled to a 56. The potentiometer-grid leak R3, in the grid circuit of the latter, functions as gain or volume control. The 56 is transformer coupled to a 46 used as a triode, with the No. 2 grid tied to the plate. The plate of the 56 is shunt-fed through the resistor R7. The blocking condenser C5 keeps the DC out of the primary winding of the transformer T1, at the same time permitting the audio frequency component of the plate current (representing the amplified microphone current) to pass to the primary for further amplification.

The two 46s in the output stage function as class B amplifiers, the two grids being connected together in each tube. The secondary of the output transformer T3 connects merely to the two posts marked "MOD" in the transmitter; i.e., directly in the plate circuit of the final amplifier. A 0-300 MA milliammeter acts as a visual modulation indicator.

The power supply consists of the transformer T4, an 83 mercury-vapor rectifier, the chokes T5 and T6, the filter condenser C9 and

* Engineer, Wholesale Radio Service Co., Inc. C10 and the bleeder resistor R10. Filament

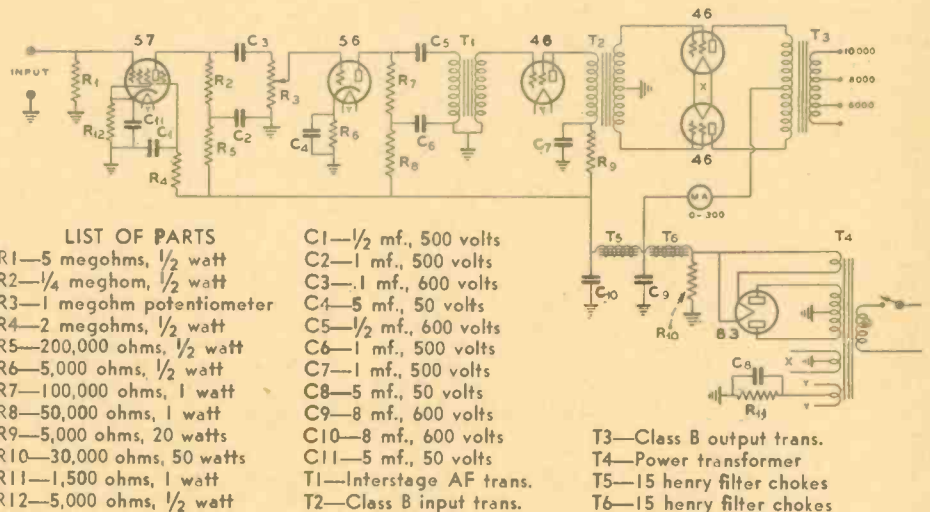

5-Meter Auto Set

(Continued from page 11)

soldering lugs. Once its correct length is determined it can be coated along one side with Duco cement to be sure that it will retain its proper inductance.

The semi-variable coupling condensers, marked 3-30 mmfd in the circuit, can be the small compression type condensers with mica spacers. The one on the transmitter (for maximum frequency stability), should be an air spaced plate variable condenser with screwdriver slot adjustment. The main oscillator tuning condenser can be either dial or screwdriver slot controlled. Since this circuit uses a TNT circuit with resonant untuned grid coil, it will give maximum results over only about two MC. The 15 turn coil specified is for use around 58 to 60 MC.

This set is to be used with a dynamotor for power supply from the car 6-volt battery. A microphone filter is built into the dynamotor and consists of a 100 ohm resistor and a 20 mfd 25 volt electrolytic condenser. The latter provides a return path for the voice frequencies, while the 100 ohm resistor acts as an impedance to noise from the common

battery supply. The circuit is shown for use in a car with "plus" terminal grounded to the car frame. If the negative terminal is grounded, this 20 mfd electrolytic condenser would have to be reversed in polarity. 5-meter RF chokes would be necessary at the dynamotor to prevent excessive receiver noise also.

A built-in five-inch magnetic loudspeaker is incorporated so as to eliminate the need of wearing a telephone headset while driving. As can be seen from the pictures, the set was built into a very narrow steel can for the purpose of mounting it on the under side of the car roof. The outside dimensions of this can are 3-in. by 11-in. by 12-in. and the back cover fastens by screws to ribs in the car roof. The set can be mounted in back of the windshield, where the send-receive switch and controls will be convenient to the driver's right hand. This also puts the loudspeaker in a good position. The mike is a W.E. 266 watchcase type, which can be gripped in the right hand and still leave one's forefinger and thumb free for use in switching or tuning the set. This eliminates the need of a remote control tuning and volume control, as well as a send-receive relay.



THE

AMATEUR ENGINEER

DESIGN AND OPERATION OF TEST AND MEASURING EQUIPMENT FOR EVERY RADIO PURPOSE

A Simple Vacuum-Tube Voltmeter

By FRANK C. JONES

● A vacuum tube voltmeter has many uses in an amateur or service laboratory. It can be used to measure AC voltages of any frequency from 30 cycles up, through the audio range, and also the RF frequency ranges. It is also useful for determining the audio response of an amplifier, a radio receiver, the gain of an audio or radio frequency amplifier. It can even be used to measure percentage of modulation of a phone transmitter or to run the frequency characteristic of the latter. Next month a simple full-wave linear rectifier will be shown which, when used with the peak voltmeter here described, can be used to measure both the "up" and "down" sides of a modulated carrier signal.

The vacuum tube voltmeter here shown uses a peak voltage rectifier of the diode type and a DC amplifier to enable the use of a 0-1 milliammeter for reading low voltages. The diode type has several advantages over the plate rectifier type. It is linear, not square law. Thus the meter scale can be direct reading. The diode measures peak voltage if the D.C. load is at least a megohm. This load can be divided-up into a resistance divider for multirange use. That is, the voltmeter can be used to cover from a small fraction of a volt to over a hundred volts by means of a multiplier switch which will not affect the input circuit. An ordinary milliammeter can be used instead of the costly microammeter, such as is used in the less sensitive plate rectifier type. Its one disadvantage is that it acts as a slight load on the circuit across which it is connected. For over 90% of all needs, this slight load is of no importance, and thus its other advantage can be utilized.

The circuit consists of two type 30 tubes connected as shown. One tube acts as a diode peak rectifier and the other as a simple, foolproof, DC amplifier. The latter by itself, through an extra binding post on the panel, acts as a DC voltmeter over the range

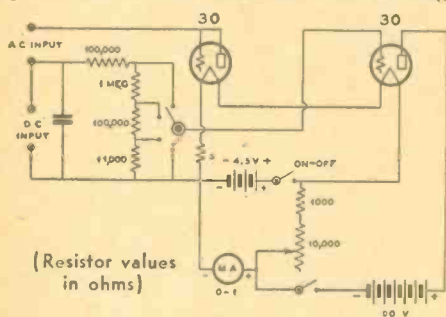

of from a fraction of a volt up to 100 volts. This DC connection draws less than 0.1 ma load for 100 volts impressed, and in the one volt range the load drawn is less than a microampere. This makes it useful in measuring DC voltages where no appreciable load can be allowed, such as the voltage developed by AVC in a radio receiver.

In the particular meter here illustrated, the resistances, tubes and battery voltages are such that for practical purposes the scale is direct reading. The multiplier can be marked 1, 10, and 100 and the scale deflection multiplied by those values for either DC or RMS voltage. The error is not over 6%. For actual peak values of AC voltage

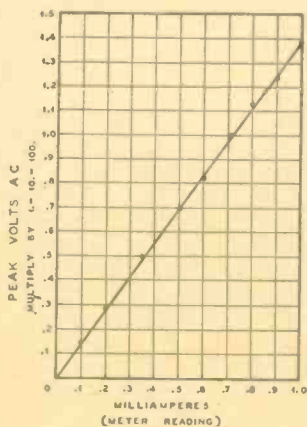

the scale reading must be multiplied by 1.4. Over a period of time this form of voltmeter should not be relied upon for better than $\pm 10\%$ accuracy because of tube and battery age. For any individual set of measurements a calibration can be made, although generally the relative ratio of voltages is the important thing. The voltmeter is accurate for this purpose.

The resistances used as a multiplier should be fairly accurate, certainly not less than 5% error can be tolerated in their values. Any form of rotary single-pole switch can be used for switching the grid of the DC amplifier tube along the points of the multiplier. This switch should have no dead positions between points, otherwise it will leave the grid circuit open. It should have good bakelite insulation so as to avoid leakage.

The 10,000 ohm resistor should be set so as to put the metal needle to zero when there is no impressed AC voltage. This resistor makes use of the $4\frac{1}{2}$ volt A battery as a bucking battery to balance out the steady current drawn by the DC amplifier from the 90 volt B battery. This tube should operate as a linear amplifier in order to keep the calibration linear, or direct reading on the meter scale.

The 5 ohm filament resistor provides about a quarter volt negative bias on the diode to prevent current from flowing in the multiplier resistors when no AC voltage is impressed. This makes the 10,000 ohm resistor control setting practically constant for any step on the multiplier.

Needless to say, the polarity of the batteries and the milliammeter should be exactly as shown. If any trouble is had from inability to set the meter to exactly zero with the variable 10,000 ohm resistor, a vernier adjustment can be added by putting a 200 ohm variable resistor in series with the 10,000 ohm resistor. The battery switch should preferably be a DPST switch in order to open-up the plate circuit at the same time the filament and bucking battery circuit is opened. A 1000 ohm resistor in series with the 10,000 ohm variable resistor limits the current drawn from the bucking battery so as to prevent meter burn-out if this control is advanced too far for a short time.

A bakelite front panel is used to simplify insulation problems. It measures 5x8x3/16 inches and is mounted at right angles to a wooden baseboard. The latter holds the tubes and batteries, as shown. The aluminum cover is 5x9 inches and serves to protect the instrument from dust and breakage.

In using this VT voltmeter it is necessary to have a DC path through the circuit under measurement. Most circuit measurements provide such a path, although occasionally a path must be provided by means of the secondary of an audio transformer for audio frequency measurements, or an RF choke for RF measurements. In such cases, the choke should shunt the AC input binding posts. The DC path resistance of the circuit under measurement can be as high as 50,000 ohms without affecting the calibration of the VT voltmeter.

This meter is useful in lining-up a radio receiver. It can be connected across the last IF coil or across the audio amplifier, and a modulated oscillator used as a signal generator. It is possible to check either stage of a receiver in order to locate trouble. The uses of such an instrument in connection with audio amplifiers has been covered thoroughly in most all radio books and it can easily be the most useful piece of equipment in an experimenter's possession.

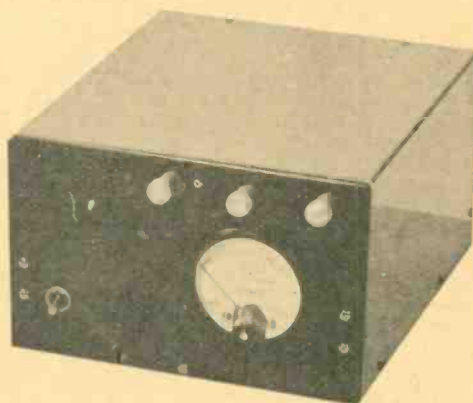

Views of the Completed Instrument.

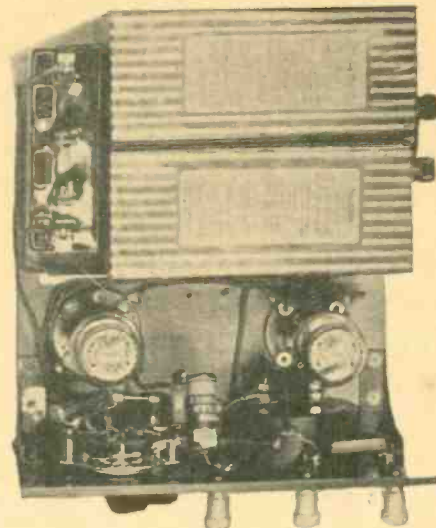

AMATEUR ALL STANDARD LINES HEADQUARTERS WE SERVE YOU BEST.

SEND FOR THIS CATALOG!
IT LISTS EVERYTHING FOR SHORTWAVE
TRANSMITTING AND RECEIVING

Aerials
Chokes
Coils and Forms
Condensers
Crystals and Holders
Dials and Knobs
Insulators
Jacks, Plugs
Keys - Meters
Monitors



Oscilloscopes
Power Packs
Preselectors
Relays
Receivers
Resistors
Sockets
Transformers
Transceivers
Tubes - Tubing
Wave Meter

NOW IN STOCK
THE NEW RCA-ACR 136
COMMUNICATIONS RECEIVER
Write for Literature

SEND FOR THE ALLIED CATALOG

Allied Radio

ALLIED RADIO CORPORATION
833 W. Jackson Blvd., Chicago, Dept. J.
 Send me your FREE 1935 Catalog.
 Send me the RCA-ACR 136 Bulletin.

Name
Address
City

7-POINT MIKE FELL 20 FEET

... STILL GOOD AS EVER

... AND STILL NO FEEDBACK!
Johnston P. A. Service, Oneonta, N.Y., writes us: "We are certainly well pleased with your velocity mike (the 7-point Mike). We believe that no other mike can take the punishment it has and still work. One time it fell 20 feet to the ground. And dozens of times it has seen rain. We use it in our mobile outfit, and it's just as good as ever. Also a wonderful help in eliminating acoustical feedback." Guaranteed. Order from your wholesaler, or write for illustrated Bulletin R2.

THIS

NOT THIS

AMPERITE Corporation
561 BROADWAY NEW YORK

AMPERITE VELOCITY MICROPHONE

Learn Radio IN 10 WEEKS

BY SHOP WORK - NOT BY BOOKS
I'll Finance Your Training!
Prepare for jobs in Service Work, Broadcasting, Talking Pictures, Television, Wireless, etc., by 10 weeks practical shop work in Coyne Shops. Free Employment Service. Many earn while learning. Write for BIG FREE RADIO and TELEVISION BOOK, and details of my "Pay-After-Graduation" Plan. H. C. LEWIS, President, COYNE RADIO SCHOOL 500 S. Paulina St., Dept. 35-3M, Chicago, Illinois

\$1 brings you the next four issues of "RADIO"—Subscribe NOW.



SCRATCHI

Osockme, Japan.
January 23, 1935.

Editor of Free Prize
Department of "RADIO"
Dear Ed:—

This is hamfest season of year, and Scratchi find numerous and many invitations in male box for requests of presence at attendance at such. Cost for tickets very from two \$ and reverse. Such hamfest each try to undo and outdo one and each other until time soon come when radio manufacturers will be asked to donate entire year production of parts to give away in form of free prizes. One manufacturer have writ me private personal letters some weeks hence in which he ask for my humbling opinion as to solution of problem. I make answer to him far better to go into automobile manufacturing business because people who go to automobile meetings are not given free cars as prizes every time crowd get together for hamfest and drinks.

It are beyond reason of Scratchi brain scope to see into dense scheme where radio manufacturers are required to give next year's dividends in form of radio parts to each of several hundred hamfests which are held about in all cities so often that special calendars are soon make publish to show with red circles each day of month on which some hamfest are not held somewhere someplace, at some time or in future.

Scratchi have make round about tour of radio shops to solicit prizes from store owners. I were make chairman goat for big hamfest here in Osockme. First dealer I go to tell me he cannot give me free prize because he are superstitious people and are afraid that prize winner will come back to his store and try to sell prize back to him for more than dealer paid for it.

Next dealer I go to call me all kinds of names which I read once in my Bible, but which do not sound so good when come from husky lungs of angry dealer. Another dealer are more good friendly person. He take me into private office and ask me what I want. I give him long list of special prizes of great value and he tell me he will take matter up and under consideration. So he open up bottle of juice of the grape and we drink from such. We then drain contents from bottle of rare old Scotch, which his brother-in-law make in spare time at home. Next we make drink from long neck, false bottom bottles of eight star McElroy and soon we begin feel pretty friendly. Dealer then bring out inventory sheets and show me how great are his business for month just past. Column on right of ledger show that eleven hundred dollars are taken in for sale of parts to radio hams, and column on left show that he give away twelve hundred dollars for hamfest prizes. So he ask me what are secrets of success in radio store business when it cost one hundred dollars more for prizes for hamfests than he take in in cash. To wich I reply with toothsome smile, such question are riddle for income tack collector to solve.

Methink he are trying to give me bum's rush, so I ask him again for free prizes. He answer by opening up another bottle of spirits of corn. We drink from such. Scratchi are not drinking man. He have never have more than two drinks at one time together. He pour another. Scratchi make protest. But he hold beautiful \$300 crystal microphone near my face and shake it in front of me. Such are great temptation, so Scratchi take another drink. He then produce huge carton of assorted high power tubes and shake them up in front of me. Scratchi take another drink. He next bring out magnificent assortment of AT-cut quartz crystals. Such are Scratchi's weakness. So Scratchi take another drink.

Hamfests are going to be huge and glorious success, methinks why not? So he pour contents of one more bottle into me. He tell me he will soon call express wagon to take hamfest prizes and me home together. By time that express wagon arrive, Scratchi are half way on road to Limbo. I are so full of happiness I bubble inside and outside. Dealer friend give rapid instructions to store clerk to carefully wrap up large assortment of prizes for Scratchi to take homeward. While clerk are wrapping such prizes, Scratchi hear sounds that are like glass clicking together. Ah, think I, such are assortment of large power tubes which dealer will donate. So Scratchi take another drink. Success are closer at hand.

Dealer friend walk in with huge package under his arm and hand to express-man. Scratchi are overcome with great happiness and chuckle forth (Continued on page 28)



Lady-Call Constable Centralab!

By cracky . . . he'll soon put a stop to that noisy "picket fence" attenuation. If your radio acts up, Madam, call a good serviceman . . . he'll change that noisy-wire-wound control to a smooth as silk CENTRALAB Radiohm that will forever banish "picket fence" reception.
Note to servicemen: A mere handful of CENTRALAB RADIOHMS will service practically any radio that is still worth fixing. Employs the smooth, non-rubbing contact in both high and low resistance values. Furnished with fixed minimum external resistor at no extra cost.

Radiohms Resistors
Suppressors
Sound Projection
Controls

Every Radio Service Man
should be a member of the
Institute of Radio Service Men



Centralab

(Division of)
GLOBE UNION MFG. CO.
MILWAUKEE

At Last! - - - NAME PLATES



YOU have always wanted transmitter and associate equipment name plates—now you can have them—and at a really low price, too. In the list you will find plates covering every conceivable requirement.

Specifications: Made of brass with characters and border chromium plated, satin finish. Background etched black. Size: 2 1/2 x 1 1/2 inches. Corners rounded. Furnished complete with self-tapping machine screws for mounting on metal, bakelite, or wood.

LIST OF NAME PLATES AVAILABLE

Oscillator	3rd Buf.-Dblr. Plate	Microphone
Crystal Osc. Plate	3rd Buf.-Dblr. Grid	Gain Control
Crystal Osc. Grid	Power Amp. Plate	% Modulation
Tritet Osc.	Power Amp. Grid	200 Ohm Input
Tripler Plate	Antenna	200 Ohm Output
Tripler Grid	Neut. Condenser	500 Ohm Input
Transmitter	Plate Voltage	500 Ohm Output
1st Buffer Grid	Filament Voltage	50 Ohm Input
2nd Buffer Grid	Key	50 Ohm Output
3rd Buffer Grid	Rectifier	125 Ohm Input
1st Buffer Plate	AC Input	125 Ohm Output
2nd Buffer Plate	Modulator Plate	Input
3rd Buffer Plate	Modulator Grid	Output
1st Buf.-Dblr. Plate	Class B Modulator	Transceiver
1st Buf.-Dblr. Grid	Class A Modulator	Monitor
2nd Buf.-Dblr. Plate	Sp. Amp. Dvr. Plate	Send
2nd Buf.-Dblr. Grid		Receive

NET PRICE, EACH, plus postage
COMPLETE WITH MOUNTING SCREWS 10c
At your favorite jobbing supply house.
Illustrated circular upon request.

GORDON SPECIALTIES COMPANY
233 EAST AVENUE PARK RIDGE, ILLINOIS

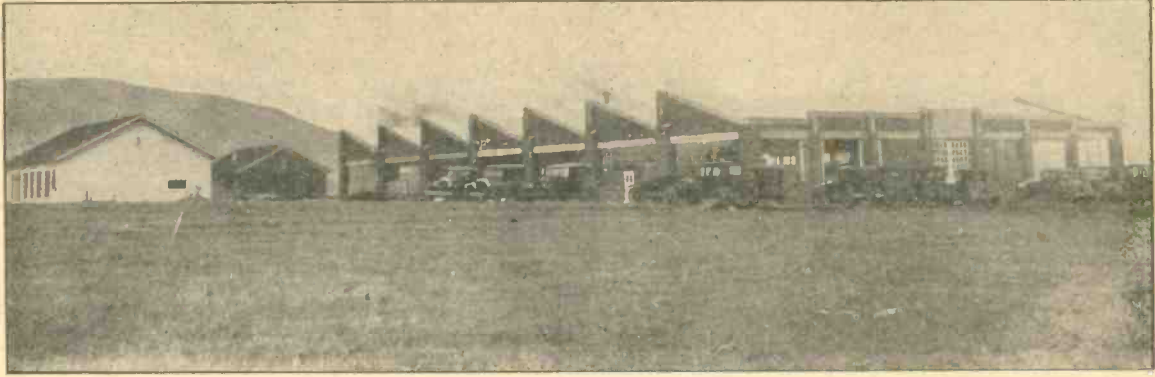

First Determine What's Behind the Product Before You Buy!

The New Improved HK 354 Gammatron

TAKE no risk! You cannot afford to experiment when purchasing high-power transmitting tubes. You must know in advance that you are getting value for your money, that the guarantee behind the tube means what it says. You want to know that your tube was engineered by men who have spent a proverbial lifetime in the design of just ONE line of tubes . . . tubes for your transmitters. The HK-354 GAMMATRON is the ace among transmitting tubes. For behind it is a pedigree . . . 20 years of sound engineering, painstaking care to see that only the finest tubes leave the factory. You do not experiment when you buy an HK-354 GAMMATRON. Here is a tube that will convert your input power into radio frequency power more efficiently than any other tube on the market. A tube capable of handling one kilowatt input for your C.W. transmitter.

Behind this HK-354 GAMMATRON is the Heintz and Kaufman factory, utilizing over 40,000 square feet of floor area. It is a sound establishment. Here the finest transmitting tubes are made, and supplied to large maritime and commercial communication companies. The engineering skill behind the HK-354 GAMMATRON is proved in practice by the hundreds who now have these new tubes on the air. Ask any amateur who uses a HK-354 GAM-



150 Watt Plate
Dissipation
High Mutual
Conductance
High Out-Put
Easy to Excite

Write for
Engineering Bulletin

MATRON. Let him tell you how easy it is to excite . . . how rugged its construction, how efficient its operation.

In the HK-354 GAMMATRON you find a Tantalum plate, most costly plate material known. The envelope is made of NONEX glass, hardest, finest for high-power tube design. The plate and grid supports are original, as is the massive base and socket structure. The filament is a husky one, 5 volts at 10 amperes, rigidly supported maintaining a high uniformity of characteristics.

HK-354 GAMMATRONS are built to STAND UP. It took years to perfect this tube. It requires expensive and special manufacturing equipment. In the Heintz and Kaufman plant where these tubes are made, the most exacting engineering and manufacturing methods are maintained. Every HK-354 GAMMATRON is PERFECT when it is shipped to your dealer. The immediate success which this tube has attained is the talk of the better amateurs everywhere.

Want a testimonial? Ask the fellow on the air what he thinks of the HK-354. You will never be satisfied with anything less. The price . . . \$24.50 net. Leading amateur supply houses stock the HK-354 GAMMATRON. Go see them!

These Authorized HK Dealers Have the 354 in Stock

BOSTON, MASS.
The Radio Shack, 46 Brattle Street

CHICAGO, ILLINOIS
Mid-West Radio Mart, 520 So. State St.

SAN FRANCISCO
I. S. Cohen's Sons, 1025 Market Street
Zack Radio Supply, 1470 Market Street

OAKLAND
Electric Supply, 51 - 12th St.
E. C. Wenger, 1020 Oak St.

SPOKANE, WASH.
Spokane Radio Company, Inc., 611 1st Avenue

PORTLAND, OREGON
Stubbs Electric Company, Park and Couch Streets

ST. PAUL, MINN.
Lew Born Company, 2484-2486 University Avenue, Midway

NEW YORK, N. Y.
Wholesale Radio Service Company, Inc., 100 - 6th Avenue

YOUNGSTOWN, OHIO
Ross Radio Company, 46 E. Federal St.
NEWARK, N. J.
Kalter & Romander, 62 Court Street

LOS ANGELES
Pacific Radio Exchange, 729 South Main Street
Radio Supply Company, 912 South Broadway
SEATTLE, WASH.
Seattle Radio Supply, 2319 2nd Avenue
Northern Radio Company, Joseph Vanca Bldg.



SOUTH SAN FRANCISCO, CALIFORNIA

Shhh! Shhh!

QUIET

Please!



Individually TESTED
for NOISE

Of course, you've heard
OF it—but you've
never HEARD it!

The New
ELECTRAD
VOLUME CONTROL

Is
GUARANTEED
QUIET



HERE is the great achievement of modern radio engineering—a volume control, so radically improved in design and smooth in operation, it is *guaranteed quiet*

The resistance element is baked on the flat outer rim of a rigid Bakelite ring. Over this, the special-alloy floating contact gently glides in a *straight* path.

More even distribution of current and longer life are attained. Molded Bakelite case, when mounted, projects only one-half inch back-panel. New type power-switch (*approved by underwriters*) instantly attached or detached. Long, easy-to-cut, aluminum shaft. All standard values.

175 Varick St., New York, N.Y.
ELECTRAD
1935 CATALOG

MAIL COUPON FOR

ELECTRAD, Inc.
175 Varick St.,
New York, N. Y.

Please send new 1935 Resistor Catalog . . . Check here for folder on new QUIET Volume Control.

Name
Address
PR-3

CANNON-BALL HEADSETS

Made by America's oldest
manufacturer of headsets

Heavy bar magnets, double pole, aluminum cases, D. C. resistances of 2000, 3000 and 5000 ohms. Sturdy construction, sensitive and faithful in reproduction.

Sold everywhere in America
C. F. CANNON CO.
SPRINGWATER, N. Y.

SCRATCHI

(Continued from page 26)

and fifth with delirious words of kindness and thanks for dealer friend. So he give me another drink.

And when I wake up in my home several days thereafter and look around me, I make wonder where I have been in my past absence. I recall I have make visit to dealer store for hamfest prizes. Lo and be hold and be dropped, I see in corner of room huge package which dealer friend hand to express man when he take me and hamfest prizes home in company together. He are my pal, he are my pal, I shout with glee. He fill me full of liquor sprits, he send me home in express wagon, and he send along great package of hamfest prizes.

I quickly open large bundle to see what make and type of power prize. What do I find? Fourteen empty liquor bottles and a bill for \$12 for liquor I consume in his store.

I make rapid foot to dealer store and demand explanation for such joke. Dealer friend say it are no joke and he inform me that he have long since gone out of radio business because he were forced to give away more prizes for hamfests than merchandise he sell in each year. He say he keep radio store sign on front door only as lifetime reminder to him to show him how much more profits there are in liquor business than in running radio store.

As I make say more previously, Hon. Ed., he are my pal, he are my pal. Hoping you will always be the same, I am,

Your Hamfest Prize Promotor,
Hashafist! Scratchi.

**The Single Tube
35-19 Transceiver**

(Continued from page 11)

monitor the speech. This circuit is so simple that two sets can easily be built for duplex operation, using one as a receiver and the other only as a transmitter. A 6.3 volt pilot lamp is a useful tool for testing this set. A single turn of wire about an inch in diameter enables this lamp to be coupled to the oscillator coil. It should light up when testing the transmitter; when the mike is spoken into loudly, the lamp should become somewhat dimmer. Too-loose coupling will give no modulation and too high coupling will cause the transmitter to stop oscillating due to excessive absorption modulation. A low resistance single button microphone should be used.

FORMS CLOSE ON THE 10th OF MONTH

RATES 10¢ PER WORD PAYABLE IN ADVANCE

**CLASSIFIED
RADIOADS**

QSLs, 75c per 100. 2 colors. W9DGH, 1816 5th Ave. North, Minneapolis, Minnesota.

MODULATED OSCILLATORS. Built to specifications of A. Binneweg, Jr., as described in this issue. Mounted in neat metal case. Vernier Dial. Calibrated for the 15 to 200 meter range. Two-volt DC Model, complete with three calibrated coils and the two tubes, \$13.00 net. AC Model, less power pack, \$16.00 net, complete with calibrated coils and the two tubes. Calibrated AC Model with built-in power, for 110-volt AC operation, \$20.00 net, complete with calibrated coils and the two necessary tubes. **DELFT RADIO MFG. CO., 524 Fairbanks Ave., Oakland, California.**

RADIO ENGINEERING

RCA Institutes offers an intensive course of high standard embracing all phases of Radio. Practical training with modern equipment at New York and Chicago schools. Also specialized courses and Home Study Courses under "No obligation" plan. Illustrated catalog on request.



RCA INSTITUTES, INC., Dept. RA-34
75 Varick St., N. Y. 1154 Merchandise Mart, Chicago
Recognized Standard in Radio Instruction Since 1909



MICA CONDENSERS



... **AEROVOX Engineered**

There's ample reason why Aerovox Types 1455, 1456 and 1457 Mica Transmitting Condensers depart from conventional design. For instance:

- Flat top and bottom permit perfect stacking for compact assemblies or condenser banks.
- Insulated mounting holes permit any mounting independent of electrical connections.
- Insulated terminals permit any combination or individual wiring, series or parallel connections.
- Special terminals permit soldered connections without harmful heat transfer to encased section.
- 1000, 2500 and 5000 Volt D.C. ratings. Wide range of capacities. Values stamped on each unit.

Aerovox engineering spells *quality*. Aerovox mass production spells *low price*. Remember, Aerovox list prices are equal and in many instances lower than competitive makes. Why pay more and get less?

FREE DATA: New 1935 Catalog is yours for the asking. Also sample copy of Research Worker. Look for yellow and black carton when buying condensers or resistors.

AEROVOX CORPORATION

84 Washington St. :: Brooklyn, N. Y.

LEARN CODE QUICKLY

AND EASILY AT HOME.
THE
INSTRUCTOGRAPH
Enables You to Practice
ANY TIME - ANY WHERE
ANY SPEED



The most practicable method of learning the code on the market today. Leading schools and the Government use tape machines because there is nothing better.

START NOW with the aid of an **INSTRUCTOGRAPH TO QUICKLY MASTER THE CODE** and send intelligently with the best of them.

For sale (cash or terms) or for rent at a reasonable price. Rental can be applied on purchase price. One additional month free if rented for 2 months. A post card will bring full particulars.

INSTRUCTOGRAPH CO.
915 LAKESIDE PLACE, DEPT. S.F. 3 CHICAGO
Representative for Canada: Radio College of Canada,
863 Bay Street, Toronto, Ont.

An Efficient Condenser Analyzer

By GLENN H. BROWNING

SOME time has been spent in making a survey of the serviceman's problem to determine what apparatus is the cause of most of his calls. The answer seems to be that condensers and resistors probably cause more trouble than any other of the component parts of the radio receiver. Most servicemen even though technically trained do not have apparatus which will quickly and conclusively give them indications of the actual conditions of various types of condenser. With these facts in mind, the Tobe Deutschmann Corporation started developments on an instrument which would give positive indications on various types of capacitors commonly employed and thus materially reduce the time taken in locating and repairing faults.

There are many simple tests for determining whether or not condensers are open-circuited or short-circuited, but in most of these tests, the voltage applied to the condenser is much below its operating voltage and, consequently, does not give conclusive proof as to whether or not the condenser is defective. The writer has tested many condensers at low voltage which appeared to be satisfactory though these same condensers when tested at operating voltages had a resistance low enough to condemn them. The above statement holds true for either solid dielectric type—such as the ordinary paper impregnated condenser—or electrolytic condensers.

As most condensers have a DC voltage impressed across them, it would seem logical to employ a DC test voltage. A satisfactory test for most solid and electrolytics may be made by measuring the leakage current, or the resistance, at—or slightly below—their rated potential. If a condenser has too low a leakage resistance it means that the dielectric is poor and that either deterioration has set in due to moisture, chemical action or carbonization, or that the original materials were not high grade. The leakage resistance of a condenser itself, however, must not be confused with the leakage over the surface of the dielectric used to support the terminals. This on damp, humid days may be in itself a considerable amount compared to the leakage through the dielectric of a solid condenser. Figure 1 shows the two leakage paths. The capacity of the condenser we shall assume to be 1 Mfd. It is a solid dielectric condenser. Therefore, the leakage resistance through the dielectric itself (R2) should be over 25 megohms. On damp days R1, the leakage over the bakelite supporting the terminal lugs might be as low as 10 megohms, so that the total resistance of the cased condenser would be a trifle less than 10 megohms. However, on a dry day the resistance of the condenser would be 25 megohms.

If the resistance of the dielectric in a solid condenser as exemplified by R2 drops below 5 to 10 megohms, breakdown is almost sure to follow if the condenser is being operated at a voltage near that for which it is rated, and thus is a good criterion as to its condition.

This same argument holds true for electrolytic condensers, even though inherently the leakage of this type is very much higher and therefore the DC resistance a great deal lower. In testing for leakage resistance on this type of condenser, it is even more important to use a test voltage which is approximately the value at which it is being operated.

If this type of condenser has been out of service the leakage will be unusually high when voltage is first applied due to the fact

that the anodic film has somewhat dissolved or disintegrated, the film will be reformed upon the application of potential if the condenser is satisfactory. The formation process, however, will take an appreciable length of time varying from a few minutes to a few hours. This salient fact should be kept in mind when testing electrolytic condensers by any method, for otherwise good condensers will be condemned.

There is another factor which will determine the worth of any capacity which is used for by-passing A.C. currents; that is, its power factor. Power factor is really the energy dissipated at a given frequency per unit voltage. It is defined as the watts loss divided by the AC voltage times the AC current through the capacitor. It is essentially an AC measurement and depends on the frequency and voltage applied. It is a very worthwhile criterion, but is difficult to measure at a rated voltage and at the frequencies which are being by-passed by the condenser.

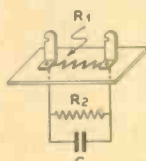

FIG. 1

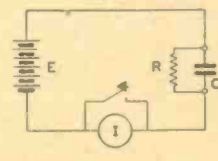

FIG. 2

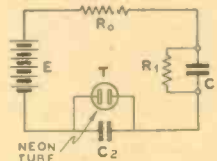

FIG. 3

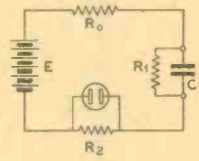

FIG. 4

Serious consideration was given to this question before the apparatus described was designed.

The fundamental or direct method of measuring resistance is to impress a known voltage and measure the current produced. The resistance is then, of course, the voltage divided by the current. In measuring the DC resistance of a condenser by this method the condenser must first be charged, for at the instant the DC voltage is applied there is a considerable flow of current which is stored up in the condenser itself. In fact this charging current is many, many times the leakage current so that any sensitive current measuring instrument placed in a circuit such as shown in Figure 2 would have to be shorted to prevent its being damaged.

Let R be the leakage resistance of the condenser C which we will assume is 25 megohms. Let the voltage E be 500 volts. After the initial surge of current into the condenser, the total quantity of which is Q, the meter key is opened, the current will then be entirely due to the resistance R and its value will be 20 microamperes. The average serviceman does not have, as a rule, either the 500 volts DC or the sensitive meter with which to measure these values. However, there is a much simpler and more effective means of determining these quantities.

Let us consider the circuit shown in Figure 3. E is again 500 Volts DC. R0 is a limiting resistance of 100,000 ohms so that if the condenser C1 being tested whose leakage resistance is R1, is shorted no damage will be done the Neon tube T. C2 is a condenser across the neon tube. When the voltage is first applied (C1 and C2 are in series) the total flow of charging current into the condensers is Q. This quantity of charge develops a voltage across C1 equal to $E_1 = Q/C_1$ and a voltage across C2 equal to $E_2 = Q/C_2$. If C1 and C2 are equal in capacity E1 and E2

will be equal and each will be half of the total voltage E. The action of the neon tube across C2 will be as follows. As is well known a neon tube has essentially an infinite resistance until the voltage across it reaches a certain critical value whereupon the gas in the tube is said to breakdown giving rise to visible light. When this discharge takes place the resistance of the tube is lowered to a small value. If the potential to which C2 is raised is above the critical value for the neon tube the tube will flash, thereupon discharging the condenser C2 to a voltage below the critical value for the neon tube. It should be kept in mind that C2 is not completely discharged. If there were no leakage in the test condenser the initial flash of the tube would be the final one. However, the leakage R1 will charge the condenser C2 to a potential sufficient to again flash the tube. The time taken for this second charge will depend upon the value of the resistance R1, the larger R1, the longer the time. By a proper choice of value for C2 and a given neon tube one flash per second will denote a resistance in the test condenser of say 25 megohms. If the condenser under test is open,

there will be no charging flash of the neon tube, while on the other if it is shorted the tube will glow brightly. If the leakage of the condenser under test is excessive, the tube may glow steadily or flash rapidly according to leakage value. Thus a neon tube and a condenser have been made to take the place of a sensitive meter for testing condensers and actually has a number of advantages over the meter, among which are ruggedness, ability to denote higher resistance than a very sensitive meter, and ability to test a shorted condenser without damage.

There are many details of design which have not been discussed, such as the effect of leakage in the condenser C2 upon the period of flash, however, the general principles have been disclosed.

In order to test electrolytic condensers somewhat the same process is applicable, but the circuit arrangement must be changed in order to meet the comparatively high leakage requirements obtained in this type of capacitor. The condenser across the neon tube is replaced with resistance of appropriate values, as shown in Fig 4. When the electrolytic condenser C1 with a leakage resistance R1 is placed across the test terminals and the voltage applied as before there is a surge of current into the condenser. This current passes through the resistance R2 and consequently builds up a voltage across it of R2 I. This voltage will be higher than the flash voltage of the tube. The leakage in an electrolytic is high and decreases with time. If the leakage current is of sufficient value the neon tube will continue to glow until this leakage current has dropped below a certain critical value determined by R2, whereupon the tube will be extinguished. Therefore, a good electrolytic condenser being tested in that type of circuit will cause the neon tube to glow for some time and then

(Continued on page 32)

Response Curves Obtainable with the VT-1 or VT-2 Varitone

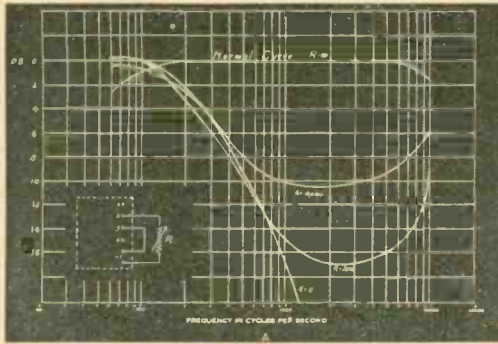

A—The connections and resultant response curve shown above are used where it is desired to bring up the low frequencies.



B—The connections and resultant response curve shown above are used where it is desired to bring up the high frequencies.



C—This system of connections brings up the low and high frequencies simultaneously.

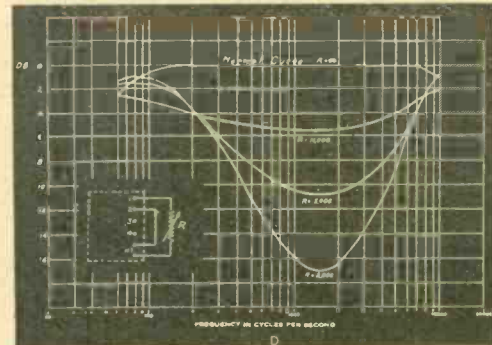

D—This system of connections brings up the low and high frequencies simultaneously. The equalization is appreciably sharper than in C, the slope of the curve being almost linear on both sides. This circuit is recommended only with an amplifier or receiver whose frequency response is unusually bad, such as a cheap midget radio.

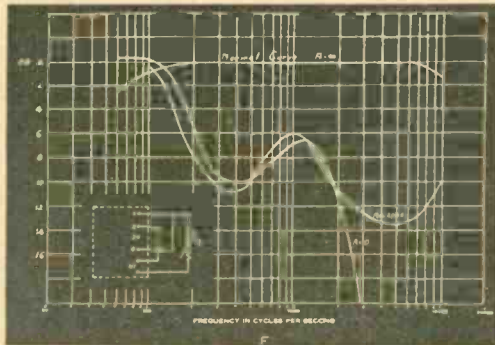

E—Many dynamic speakers, particularly when used with a poorly designed cabinet, have marked resonance at the low and high frequencies, generally in the vicinity of 400 and 4000 cycles. The system of connections above will absorb these resonances, as shown in the response curves.

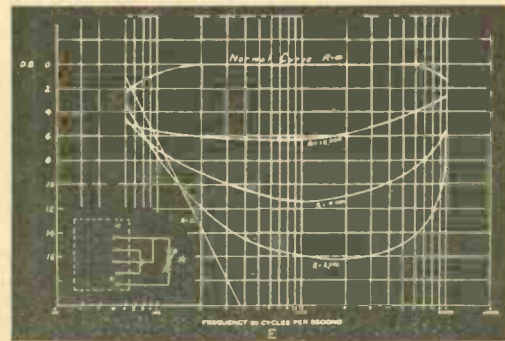

F—This arrangement of connections brings up both highs and lows to a minor extent until almost all resistance is cut out, at which time the low frequencies are brought up sharply.

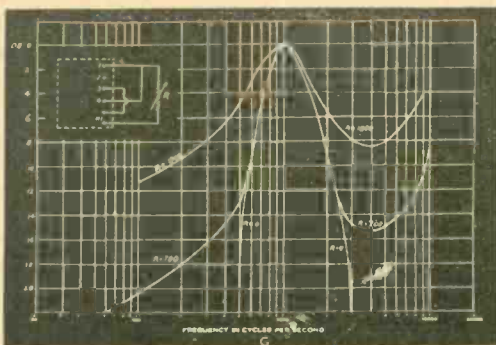

G—This system of connections is generally used with zero resistance. A sharp single frequency filter is effected which eliminates practically all frequencies but 1000 cycles. This is ideal for reception of C W, as static, heterodyne and other QRM are eliminated, affording greater intelligibility and accuracy. This sharp 1000 cycle circuit is also excellent for use with A C bridges. All harmonics, etc., are completely eliminated.

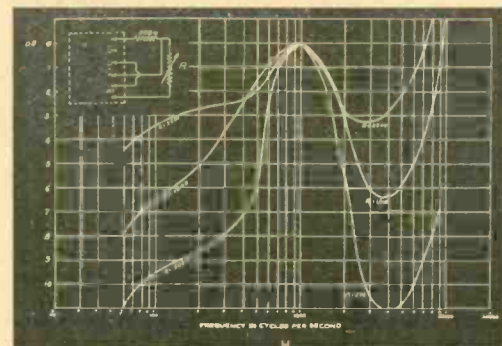

H—This circuit is ideal for the amateur, or short wave DX fan. The audio frequency range can be reduced to just the essential frequencies for intelligible speech. All extraneous static, whistles, etc., are eliminated. This arrangement of connection is also used frequently where it is desired to demonstrate poor frequency response.



VARITONE



Patent Pending

The UTC Varitone is a revolutionary audio device which permits full control of the frequency response of any audio amplifier or receiver. Using this device, tone correction can be effected for defects in acoustic conditions or overall audio response. It is also possible to produce new tonal effects from phonograph recordings or radio reception and to bring back notes which would otherwise be lost completely. Due to the high equalization obtainable with the Varitone, some loss in gain is effected. If the amplifier or receiver does not have gain to spare, it may be necessary to add an additional stage of audio frequency amplification. The Varitone is made in three types, as follows:

VT-1 This Varitone is incorporated with a universal audio transformer. Two primaries are provided. One is suitable for working from a single or double button microphone, a low impedance pickup, or a line; the other primary is designed to work out of the plate of a tube or from a high impedance pickup. The secondary winding is centertapped and is equally suitable for working into one or two grids. The types of response curves possible are shown in curves A to H.

List Price \$8.50
Net to Hams \$5.10

VT-2 The VT-2 is a varitone control unit, incorporated with an impedance matching device so that it can be connected directly across a 200 or 500 ohm line, or low impedance pickup or mike, or in shunt with the plate circuit of any triode or a high impedance pickup. The circuit is not changed in any other way. The VT-2 is solely an addition for tone correction. The original audio circuits are not disturbed. The response curves possible are shown in curves A to H.

List Price \$6.00
Net to Hams \$3.60

VT-3 The VT-3 is a complete self-contained unit which does not use external control. The components are adjusted so that 10 db. equalization is effected at 80 and 7000 cycles. This unit is connected directly from plate to B plus of first audio triode. No other alteration is made.

List Price \$5.00
Net to Hams \$3.00

	Overall dimensions			Mounting Dimensions
	L	W	H	
VT-1	2 1/2	3	4	1-15/16 x 2-7/16
VT-2	2 1/2	3	3	1-15/16 x 2-7/16
VT-3	2 1/2	3 1/2	2	3-3/16

The normal primary and secondary connections for the VT-1 and VT-2 are shown respectively in Figures 1 and 2 above. The high impedance winding can operate in conjunction with any standard triode tube. The low impedance winding will operate with any carbon mike, broadcast line, or low impedance pickup.

Figures 3 and 4 on the facing page show the most common methods of connecting the control windings of the UTC Varitone. If connected as in Figure 3; with the potentiometer arm toward one end the high frequency response is improved; at the other end the low response is improved. If connected as in Figure 4, at one end both high and low frequencies are increased; at the other end low frequencies alone are increased.

The external 50,000 ohm potentiometer may be of the standard graphite or wire wound type.

UNITED TRANSFORMER CORP.
264-266 Canal Street :: New York, N. Y.

THE UTC SLIDE RULE

The UTC slide rule is an accurate instrument designed to accomplish all standard slide rule functions such as multiplication, division, square root, squares, proportion, etc. Can also be used as a Stroboscope. In addition a scale is provided for comparison of voltage ratios against DB. This is invaluable to every man who has to work with audio

equipment. This rule has an effective length of approximately 14 inches which insures accuracy greater than most slide rules. The UTC slide rule may be purchased from UTC distributors at a nominal cost of 25c which is a fraction of its value. Or you may purchase direct from the factory by addressing our SR Dept. and telling us who your favorite distributor it.

CROWE "MICROMASTER"

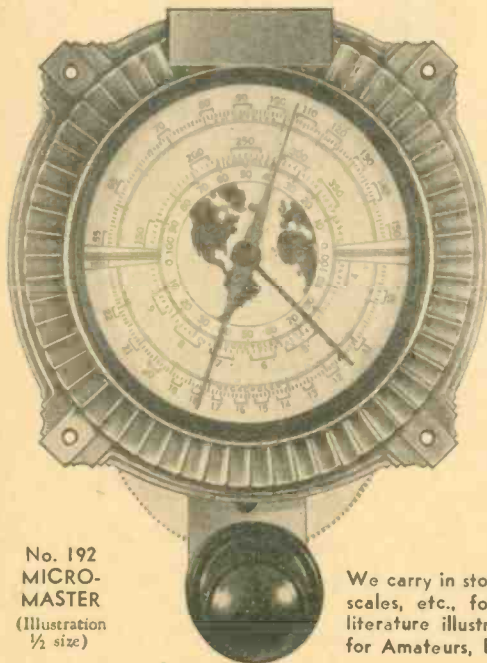

No. 192
MICRO-
MASTER
(Illustration
1/2 size)

Precision Recording Control For All Short Wave Sets

Has auxiliary pointer affording exact repeat indication of wave length. Stations however closely crowded may be accurately logged.

Slow speed ratio 45 to 1; fast speed 9 to 1 in 360 degrees. Secondary pointer travels faster than double pointer.

Can be supplied with other scales or with special calibrations made to order. Specify scale wanted. Made in several sizes: 3 1/2", 4" and 2 3/4" diameter of scale.

New escutcheons are featured for the various sizes and have a synthetic transparent non-inflammable Croglas convex crystal eliminating breakage. The crystal inserted in escutcheon seals air leakage or coupling behind baffle.

We carry in stock a complete line of name plates, dials, scales, etc., for transmitter panels. Send today for literature illustrating and describing our new material for Amateurs, Experimenters and Set Builders.

Export orders receive special attention, Cable Address—CROWNAME CHICAGO.

CROWE NAME PLATE & MFG. CO.

1755 GRACE STREET

Established 35 Years

CHICAGO, ILL., U. S. A.

Pacific Coast Representative—W. BERT KNIGHT, INC.

PERFECTION OF PERFORMANCE

IS ATTAINED ONLY BY CAREFUL ATTENTION TO EACH MANUFACTURING DETAIL

THE electrodes used in Premier Crystal Holders are typical of our strict adherence to minute details. A crystal ground flat and perfect in every other respect is worthless unless used between electrodes that STAY FLAT.

To make an electrode stay flat is not as easy as it sounds. Strains in the metal, possibly caused while the blanks are being stamped out, often produces distortions, the bad effects of which do not become evident for weeks or even months. Ultimately, the twisting of the plates, even though very slight, causes destruction of the crystal through arcing, reduces the output, shifts frequency and sometimes destroys the crystal entirely by fracturing it. It took much longer to overcome these difficulties than it takes to tell about them. Brass would not behave and was discarded. We developed a nickel silver alloy which is specially heat treated to relieve the surface and aged by a unique process.

Determination of the correct thickness of the electrodes and the extraordinary pains taken to produce them, enable us to offer permanently flat and perfect electrodes. This important detail, in addition to many others, brings to the amateur, Crystals and Crystal Holders much nearer perfection than have ever before been produced.

Write for Bulletin 103 describing sixteen types of new Isolantite holders, "AT"-cut crystals, etc.

PREMIER CRYSTAL LABORATORIES, INC.

69 PARK ROW, NEW YORK, N. Y.



TYPE 180
ISOLANTITE
HOLDER

10-Watt 160-Meter Phone Using Low-Cost Tubes

(Continued from page 15)

until the plate circuit draws about 100 milliamperes (50 mills for each tube). If you are supplying 400 volts to the final stage, and if the meter reads 100 mills, the input is 40 watts. If your power supply delivers only 300 volts to the final stage, the input is 30 watts.

To modulate 40 watts, 20 watts of modulating power is required; 15 watts of modulating power is required for 30 watts of input, etc.

By loosening the antenna coupling, the power input to the final amplifier decreases. You can tell whether or not you are completely modulating the final stage if there is a slight increase in antenna current when you speak into the microphone. Tests with nearby amateurs will be of great help in properly adjusting the entire system.

There are no adjustments of the speech amplifier, other than the correct setting of the gain control for best results. Use a monitor or a nearby receiver to listen to your voice.

The amplifier originally used for this transmitter is designed for operation with a crystal microphone. If a double button microphone is to be used, a microphone transformer and batteries must be connected between the microphone and the first audio tube. If a double button microphone is used, it is always good practice to connect a 10,000 ohm variable resistor in series with the microphone battery circuit so that resistance can be introduced when the microphone is disconnected from the circuit. This resistor is omitted from the circuit diagrams for the sake of simplicity. Before you disconnect the microphone, throw in all of the resistance of the 10,000 ohm resistor; then disconnect the microphone. Thereby the microphone itself is protected because the introduction of resistance in the microphone circuit prevents the carbon microphone granules from arcing or packing. The 10,000 ohm resistor should have a full "OFF" position, so that when the microphone is fully disconnected no battery current will be consumed.

When the microphone is spoken into, the antenna ammeter should rise about 10 per cent for correct modulation. But there should be no variation in current at any other point in the set. The audio channel uses class A modulation and high quality speech is obtained.

In addition to showing the complete circuit diagram of the laboratory transmitter here described, a number of other speech systems will be shown next month. A simplified final amplifier RF stage for straight phone operation is shown on page 15.

The equipment is mounted on aluminum chassis. A beautiful satin finish can be had by buffing the aluminum on a motor-driven wire brush.

An Efficient Condenser Analyzer

(Continued from page 29)

be extinguished. If the tube continues to glow the leakage is higher than normal, (it is assumed that the leakage at which the tube is extinguished is properly adjusted for the condenser under Test.)

The serviceman and others having occasion to use numerous condensers will find the device described indispensable once having learned to use it properly. In fact continuity of circuits may be readily checked by using the lowest voltage tap; high resistance may be measured; and numerous other uses will be found.

LITTELFUSES

Instrument Littlefuses, for meters, 1/200 amp. up.
Hi.-Volt Littlefuses for transmitters, etc. 1000, 5000 and 10,000 volt ranges, 1/16 amp. up.
Neon Voltage Fuses & Indicators (Tattellites) 100, 250, 500, 1,000 & 2,000 volt ratings.
Aircraft Fuses Auto Fuses, Fuse Mountings, etc.
Get new Catalog No. 6

LITTLEFUSE LABS., 4503 Ravenswood Ave., Chicago, Ill.

AC RADIO

**RUN YOUR A.C. RADIO
by DIRECT CURRENT**

Operates AC Radios, Amplifiers, transmitters, etc., from 6, 32 or 110 DC. See your Distributor or write.

KATO ENGINEERING CO.
Mankato, Minn., U. S. A.
Light plants \$99.00

AC Generators \$16.00

Radiotrial Comment

(Continued from page 5)

But his bands are so overcrowded that the proverbial sardine-can has rooms to let, compared with the conditions in amateur radio bands.

Let us appeal to our Congressmen so that we will be assured of amateur representation on the next Delegation to the International Convention. Let us persuade our Congressmen to help us get amateur representation on the FCC. The FCC is an administrative body. Congress makes the laws, the FCC enforces them. So we must go right to the top—to the lawmakers themselves. And if Congress helps us in our plight, it is only reasonable to assume that there should be amateur representation on the FCC in order to help enforce the laws. We, as amateurs, are people; we are citizens of the United States. We help put Congressmen in office. They, in turn, are willing and anxious to serve.

"RADIO" will throw its support to the League officials in full measure, when its administrative branch is strengthened by the hiring of more-capable men, when the affairs of the League are no longer one-man controlled, when the amateurs are permitted to select their own leaders, by popular vote, just as is common practice among numerous other societies and fraternal orders.

Amateurs who have been active for the past 20 years know what happens when boss-rule and machine politics hold sway in an amateur organization. The bosses roll in wealth, the amateur holds the sack. The big-salaried bosses don't like to admit that Congress is more powerful than they are. So when this true-American campaign of ours is further ridiculed, when you are told it is unwise to hire a paid lobbyist to fight our cause in Washington, always remember that boss-rule goes down to defeat once the public learns that some other agency is more powerful than the bosses, more able to do for the amateur what must be done immediately . . . not next year or two years hence.

QUALITY

at a Price You Can Afford to Pay!

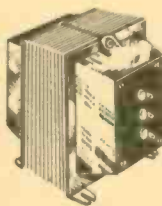

FRANKLIN Transformers

Very conservative ratings on Transformers and Chokes for every Amateur Station.

"MOST SOCK PER DOLLAR"

Write for Catalogs

FRANKLIN TRANSFORMER MFG. CO.
607-609 22 Ave. N.E., Minneapolis, Minn.

BIRNBACH Standoffs

All Sizes
5/8" to 4 1/2"

Largest and most complete selection of popular priced Standoff Insulators for supporting lead-in and ground wires, power-supply and R.F. leads, chokes, etc. 56 numbers; 28 models. Highest grade white or brown porcelain; nickel-plated hardware.

Write Dept. PR-3 for Data.

BIRNBACH RADIO CO., INC.

145 Hudson St., New York



McMURDO-SILVER

Going Into More Amateur Stations

We believe that more 5C professional superheterodynes have gone into amateur stations in the last six months than have any other commercial superhets—at least, so our sales tell us.

There must be a reason for this condition—and there is—performance plus. Ask anybody you work why he reports you R9 and we'll bet that once out of every three times a 5C in his shack will be the answer.

You know the 5C's predecessor, the 5B, was chosen and used exclusively by W9USA all through last year's Fair and that alone tells the story of performance plus. The roster of it and the newer 5C's users includes governments, commercial companies, engineering universities and amateurs. But read what the Egyptian Radio Club Boys say of it.

And get this one—the 5C is the only amateur receiver whose maker thinks it good enough to dare offer it to you on a ten day trial basis—hook 'er up, operate it for ten days, and if you're not absolutely satisfied, just return it undamaged and you'll get your money back. It's just so good we get less than half of one per cent back for refund!

Why the 5C is better

is told by its features—send a stamp and you'll get the story promptly. But outstanding are: no loss of signal strength on single signal. Automatic volume con-



THE 5-C

trol that really is automatic volume control—or cut it out by a switch. Band spread and full coverage (1500 to 23,000 kc. on one dial by pulling out the single tuning knob. One high gain real t.r.f. stage that cuts out images and boosts weak signals. Very low inherent noise. Absolute day in and day out dependability and performance such as the commercials demand.

Built in a single unit with self-contained power supply, with separate speaker and hot and cold running water—in a word, with everything the ideal receiver should have. Yet it's priced, ready to go, with speaker and eight Raytheon tubes, at \$74.70 net to you, or \$83.70 net with specially selected and aligned single signal crystal filter.

Order one today on 10-day trial and find out what a real receiver can do for your schedules

McMURDO SILVER INC. 3362-C.N. Paulina St. CHICAGO, ILL.

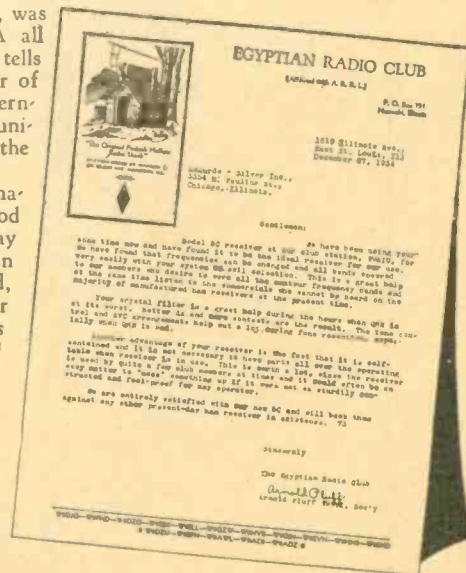

WHILE THEY LAST!

Short-Wave Sets \$7.90

Television Scanners, \$18.90

Wallace-Hoover Prize-Cup short-wave receiver kits. Finest Hammarlund parts throughout. Isolantite sockets. 3 isolantite mounted condensers. Full amateur band-spread. Finest vernier dial. Two tubes, for either two No. 30, two-volt tubes or two No. 56 AC tubes. Neat chassis. Silver-ribbon wound coils. We were western distributors for those fine sets. Former Ham price \$15.30 with coil for any one ham band. While they last, \$7.90 each, with coil for any one band. Coils available for 20, 40, 80 and 100 meters at 98c each extra. State whether two-volt DC or AC operation is desired. The two tubes, 95c extra. Sets use transposition aerial if desired. Fully described in Wallace Short-Wave Manual. Full wiring instructions furnished. First money orders take them. Only a few left. (List Price, \$25.00.)

We also have a limited number of complete television scanner kits. Complete with fine motor, scanning disc, cast stand and all fittings, large neon tube shield, magnifying lens. Absolutely complete for operation from 110 AC line. The only practical scanning system that is inexpensive. Complete kit with large 1 1/2 in. square plate neon tube, \$18.90, each while they last.

DELFT RADIO MFG. CO., 524 Fairbanks Ave., Oakland, Calif.



Browning 35

WITH
TOBE
TUNER

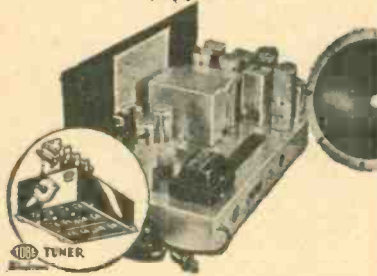

Radio Servicemen—Radio Dealers

RADOLEK

has this new Browning Drake Receiver Kit in stock, ready for immediate shipment to you. This "Wonder" receiver, with its startling array of new engineering principles is rapidly becoming one of the most popular receivers of its type. This popularity means sales and sales mean PROFITS to you. Cash in on this opportunity now—while it's "hot." As usual, Radolek is one of the first to offer to you this new up-to-the-minute merchandise.

Lowest Prices, Finest Quality, Fastest Service and Profit protection are yours when you deal with—

The Radolek Company

601 W. RANDOLPH ST., CHICAGO, ILL.

OFFICIAL DISTRIBUTOR
For the Southwest

for the

Browning 35

WITH
TOBE
TUNER

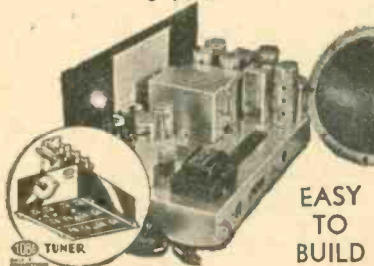

EASY
TO
BUILD

Here is the newest all wave set that under actual tests by qualified authorities, has demonstrated its superiority over receivers costing several times as much. It includes the TOBE TUNER, the heart of the Browning 35. This tuner is a pre-adjusted unit including all R.F. tuning circuits. The TOBE TUNER comes to you completely wired and aligned ready to be set into the chassis with *only seven simple connections.*

Write today for prices and complete information on the all-wave kit.

BURSTEIN-APPLEBEE CO.

1012 McGee St., Dept. PR, Kansas City, Mo.

Browning 35

(Continued from page 13)

point of maximum response (rotate clockwise as far as possible).

(3) Turn tone control as far counter-clockwise as possible without turning off the set.

(4) Set selector switch on either the second or third band. When this is done a hissing noise should be heard from the loud speaker.

The IF transformer which feeds the detector should be aligned first. Its location is given on the drawings as T2. It has already been mounted so that the adjustment screws face out from the chassis. Three of these adjustment screws will be found. The center adjustment screw is the link-tuned circuit and is not connected to either the 58 or the 2A6 tube. This circuit, as well as all the others, has been set at the factory for 456 KC intermediate frequency. The set screw that adjusts this link circuit is in the middle of the transformer. Do not change the adjustment of this link circuit for tube or lead capacity has no effect on its frequency.

The top and the bottom adjustment screws may be rotated very slightly until the maximum hissing sound is heard. A similar procedure should be followed on T1 remembering not to change the tuning of the link circuit in this transformer which is adjusted by the middle screw. To align T1 the 56 beat-frequency oscillator should be removed from its socket. Then these transformers are brought into alignment a hiss will be heard even with the 58 tube used as an RF amplifier removed from its socket.

The receiver then should be tried out for sensitivity on all bands. On the 4th band a distinct reduction in noise, even with the

(Continued on page 36)

NEWEST ALL WAVE SET

Browning 35

Here is the All-Wave Receiver that all the country is talking about. In performance it is superior to many receivers selling at several times its price.

Here at Radio Headquarters we have them in stock at

Lowest Wholesale Prices

Complete set of five full scale Plans and 24 page Booklet are available for those who want advance technical information covering design, construction and operation of the Browning 35. All complete for only—\$1.00.

Address Dept. PX-35

WHOLESALE RADIO SERVICE CO., INC.

NEW YORK | NEWARK | ATLANTA

100 Sixth Ave. 219 Central Ave. 430 W. Peachtree St. N.W.

THE NEWEST ALL WAVE SET

Browning 35

WITH
TOBE
TUNER

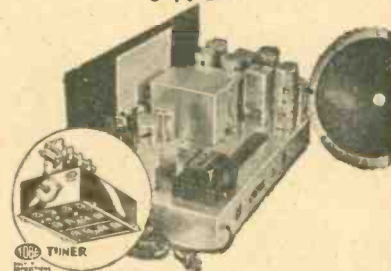

1. Triple-Tuned Double-Band-Pass Intermediates-Link Circuit.
2. Mechanical and electrical arrangement of Tuner permitting maximum gain and efficiency.
3. No plug in coils.
4. Pre-selection by means of R. F. stage.
5. Full vision dial accurately calibrated for all bands.
6. Sensitivity on all bands 1 microvolt or better.
7. Selectivity, 10 KC (absolute selectivity on all bands. Flat top tuning.)
8. Automatic and manual volume control.
9. Seven tubes.
10. Antenna connections for doublet or straight antenna.
11. Frequency range—540 KC to 22,600 KC, 4 bands.
12. Micro-vernier dial with 40 to 1 ratio.
13. Absolute single tuning control.
14. Beat frequency oscillator for C.W. reception.
15. Everything supplied in one container except tubes and speaker—\$39.90 net. To Experimenters, Servicemen and Set Builders.

For Sale By

OFFENBACH
ELECTRIC COMPANY

1452 MARKET STREET SAN FRANCISCO, CALIFORNIA

New ALL-WAVE SET

... EASY TO BUILD ...

Browning 35

WITH



TUNER

"Glenn Browning", the man who built the "Browning-Drake" in 1925, brings you his most outstanding achievement—the Browning-35 with Tobe Tuner, etc.

Here is the newest all-wave set that under actual tests by qualified authorities, has demonstrated its superiority over receivers costing several times as much. It includes the TOBE TUNER, the heart of the Browning 35. This tuner is a pre-adjusted unit including all R.F. tuning circuits. The TOBE TUNER comes to you completely wired and aligned ready to be set into the chassis with *only seven simple connections*. Below are some of the other outstanding points of the Browning 35 Receiver.

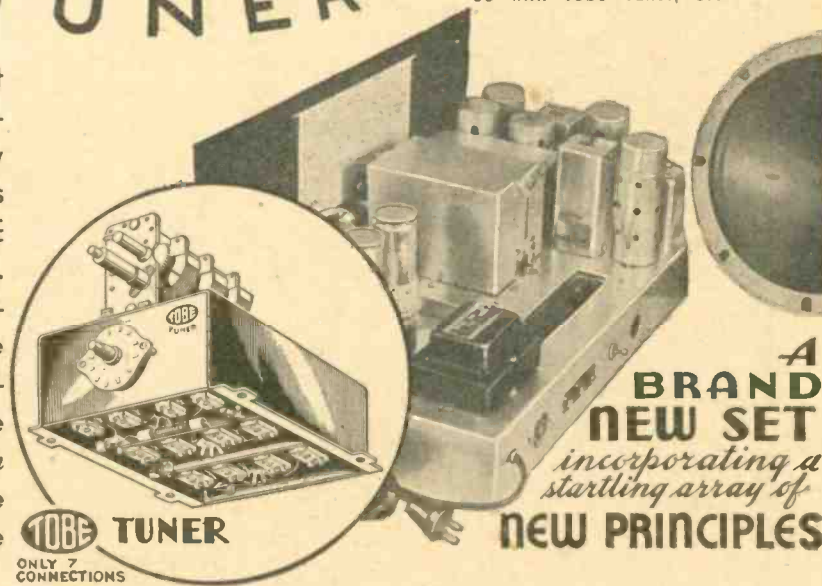

A BRAND NEW SET
incorporating a startling array of
NEW PRINCIPLES

TOBE TUNER
ONLY 7 CONNECTIONS

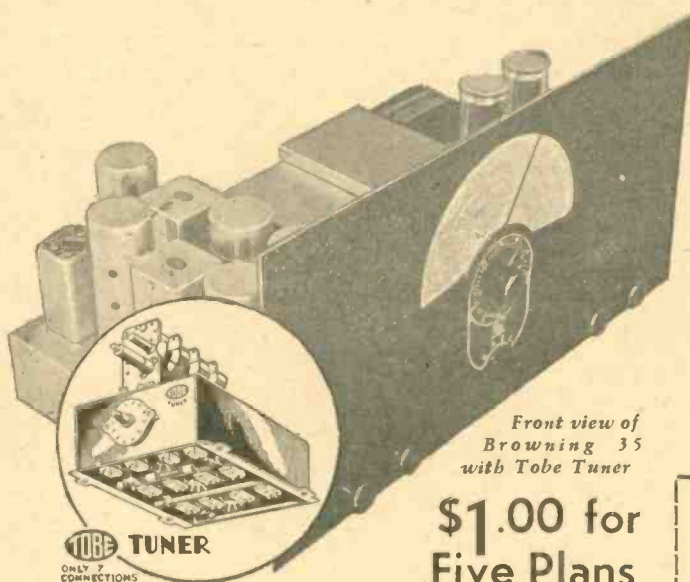

Front view of Browning 35 with Tobe Tuner

\$1.00 for Five Plans

For you who want advance technical information, we offer four Progressive Picture Diagrams (all actual size) and the schematic circuit diagram for \$1.00 plus complete information on Kit parts and price discounts. 5 plans include: 1. Schematic drawing. 2. Arrangement of parts equipment, top view. 3. Filament wiring. 4. Resistor wiring showing color code. 5. Wiring of condensers, arrangement of tuner showing 7 connections where attached.

1. Triple-Tuned Double-Band-Pass Intermediates-Link Circuit.
2. Mechanical and electrical arrangement of Tuner permitting maximum gain and efficiency.
3. No plug in coils.
4. Pre-selection by means of R. F. stage.
5. Full vision dial accurately calibrated for all bands.
6. Sensitivity on all bands 1 microvolt or better.
7. Selectivity, 10-KC (absolute selectivity on all bands. Flat top tuning.)
8. Automatic and manual volume control.
9. seven tubes.
10. Antenna connections for doublet or straight antenna.
11. Frequency range—540 KC to 22,600 KC, 4 bands.
12. Microvernier dial with 40 to 1 ratio.
13. Absolute single tuning control.
14. Beat frequency oscillator for C.W. reception.
15. Everything supplied in one container except tubes and speaker.

Special discount to experimenters and servicemen. Order direct from your jobber. If he cannot supply, write us direct for information and prices.

Tobe Deutschmann Corporation

CANTON MASSACHUSETTS

Export Dept., 105 Hudson Street, New York, N. Y.

TOBE DEUTSCHMANN CORP.,
Canton, Mass.

Gentlemen: Here is my dollar. Please send me the four full-scale Progressive Picture Diagrams (17" x 22") and the schematic circuit diagram with complete information on Kit parts and prices; also the 24-page treatise by Glenn H. Browning describing the design, construction and operation of his latest and most remarkable engineering development.

Name _____
Street _____
City _____ State _____

Out of the Brain of SCIENCE



Comes the Super SKY-RIDER

From the heart of fine laboratories, Science and keen Craftsmanship bring you the Super SKY-RIDER—a brilliantly engineered Short Wave Receiver. It is available for immediate delivery, offering you an exciting adventure in Short Wave mastery, performance marked by sure power, acute selectivity, and a reach which is uncanny in its ease and scope.

FEATURES THAT CHALLENGE:

- Four Short Wave Bands
- 5 Band Selector Switch
- Full 7 inch Bandsread
- Less than 3 Microvolts Sensitivity
- Frequency Meter and Monitor
- Air-Tuned I.F.'s: Temperature-proof
- Crystal Filter, Flexibly Designed
- An Oscillator that does not creep
- Pre-Selection for Easy Reading

THE SUPER SKY-RIDER HAS BEEN IMITATED BUT NEVER EQUALLED.

the hallicrafters

HANDCRAFT
MAKES PERFECT

THE HALLICRAFTERS, INC.
3001-L Southport Ave., Chicago, U. S. A.

Send me at once, a complete description of the Super SKY-RIDER. Also tell me the name of my nearest jobber.

Name
Address
City State

HEADPHONES for the EXPERT



The
Famous
SPECIAL
TRIMM

FEATHERWEIGHT

Precision built, like a fine instrument, sturdy, ultra-sensitive, yet the entire weight on your head is but FOUR OUNCES!

TRIMM
RADIO MFG. CO.

1528 ARMITAGE AVE. CHICAGO, U. S. A.

AT LAST



Any Battery Radio Set, whether 2 volt, 6 volt or 32 volt can now be made All Electric, with a Carter Genemotor—the modern "B" Eliminator.

Greater Power—No Current Fluctuation—Minimum Operating Cost—Electrically and Mechanically Guaranteed.

There is a Carter Genemotor for Sound Systems, Two-Way Police Radios, Transmitters, etc.

Write for our latest catalog—it's free.
CARTER MOTOR CO.

365 W. Superior St. Chicago

Drowning-35

(Continued from page 34)

antenna connected, will be obtained at frequencies higher than 12 megacycles at night. This does not mean that the set is less sensitive on those frequencies for actually there is less noise in most locations at those very high frequencies at night. If, after thoroughly trying out the receiver, it is thought that the sensitivity could be improved, the following adjustments may be made: With the antenna disconnected, set the tuning condensers at maximum and the switch on the broadcast band position. In the rear compartment of the tuner will be found two variable padding or tracking condensers, the lower one controlling the tracking of the oscillator on band No. 4 (broadcast band) and the upper one controlling the tracking of the oscillator on band No. 4 (broadcast band) and the upper one controlling the tracking on band No. 3. By turning the tracking condenser on the broadcast band (be sure the switch is set on this band) a distinct peak of noise will be heard. This is the right position for this tracking condenser. Be sure no signal is being received when making these adjustments. If it is, set the tuning condenser to a slightly different position before making the adjustments. Set the coil switch on band No. 3 and repeat this process. The padding condensers on the other two bands are comparatively large and fixed mica condensers have been employed. These condensers have been accurately measured for capacity on a bridge before being installed and are of a proper size for correct tracking.

In order to line up the trimming condensers on each coil, the variable air condenser should be set near minimum. In the front compartment (compartment toward the front panel) are the antenna tuning coils for the four bands. Leave the trimming condensers on the oscillator strictly alone. The other two sets of coils may be lined up for maximum noise as follows:

With the antenna disconnected as before and the volume controls at maximum, set the switch on the broadcast band. Looking at the chassis from underneath the broadcast coils are the ones on the left, or row No. 4. The antenna tuning coil and the RF stage then may be lined up for maximum noise. With the switch on No. 3 position, again adjust the antenna and RF trimmers on row No. 3 for maximum noise. Repeat the process with the switch set on No. 2 position and adjust the trimmers on the antenna and RF coils on row No. 2. In adjusting row No. 1, the noise level, in most cases, is very materially reduced and consequently it is considerably harder to line them up.

There is a possibility on both rows No. 1 and No. 2 of adjusting the trimmers to the "image" frequency instead of the frequency for which they were designed. Sometimes it will be found that two maximums of noise are obtained, one with the trimmers at a lower capacity and one with them at a higher capacity (lower capacity with the moving plate farther away from the fixed plate). In this case, the true alignment will be the one with the maximum capacity. If these two sets of coils are lined up on the image frequency, the variable tuning condensers will not track correctly throughout the band and consequently there will be a loss in signal strength.

\$1 Brings You the Next 4 Issues of "RADIO"—Subscribe Now

TRANSMITTING EQUIPMENT

for the
AMATEUR WHO WANTS VALUE FOR HIS MONEY

Here is a collection of outstanding NEW developments, hard to get parts and accessories as well as standard merchandise that will save money for Hams everywhere.



Left: Lafayette 100 Watt C.W. and 30 Watt phone. Described in "RADIO", November, 1934. The most economical XMTR ever offered for its rated output. Write for details.

Right: Lafayette 30-watt type B46 speech amplifier Modulator. A companion unit for the P46 C.W. unit. Designed for crystal mike, overall gain 110 Db. flat from 60 to 17,000 cycles \pm 1.5 Db. Price \$39.50.

Left: Lafayette 30 watt type P46 Transmitter. An efficient job at \$49.50 utilizing the popular Les-tet Oscillator Buffer or Doubler with a pair of 46's in parallel. Write for details.

Right: Lafayette "19" Transceiver. Described in "RADIO", October, 1934. A job that Hams all over the East are talking about. Has power output about 10 times that of similar units. Price only \$17.95. Write for details.

DIALS

4-in. highly polished nickel silver, etched figures. 1 1/2-in. intg. centers. Marked; Amplifier Plate, Amplifier Grid, Oscillator, Antenna, Buffer also Blank.

No. PXH9858, each 60c

2 3/4-in. Diam. Same as above but marked; NEUTRALIZATION also Blank. No. PXH9857, each 50c

2 3/4-in. Diam. with Aluminum figures on black. Marked; Tone, Volume, Mixer gain. Button Current.

No. PXH9859, each 10c

Be sure to specify markings wanted

INDICATOR PLATES

Rectangular aluminum plates, 1 1/2 x 3/4-in. Black Background, aluminum figures. Marked; Filament—1st On—2nd Off; Plate—2nd On—1st Off; Oscillator Plate Current; Amplifier Grid Current; Buffer Plate Current; Amplifier Plate Current; Amplifier Screen Current; Antenna Feeder Current; Output Grid. No. PXH9898, each 10c

INDICATOR KNOBS

Black bakelite 2 3/8-in. diam. for 1/4-in. shafts. No. PXH9895, each 22c

Black bakelite 1 1/2-in. diam. for 1/8-in. shafts. No. PH9896, each 17c

POINTER KNOBS

Black bakelite. Fine for test equipment, transceivers, etc. 1/2-in. shaft with set screw. White engraved line.

No. PXM13055, 2 1/4-in. long, each 10c

PXM13054, 1 1/4-in. long, each 09c

CIRCULAR PLATES

Black background, aluminum figures, 1-in. diam. 7/8-in. hole. Marked; Mike-Phone, Cell Disc; Adjust-Cell Voltage; On-Off.

PXH9899, each 10c

INDICATOR PLATE

Black background, aluminum figures, marked CW-Phone Switch.

PXH9918, each 15c

GENERAL UTILITY CABINETS

Black Crystalline finish. For X'mitting units. Receivers, mixers, input stages, etc. Four standard sizes:

PXY22174, 5 1/2 x 6 x 5 1/2, each 69c

PXY22175, 5 x 9 x 6, each 99c

PXY22176, 8 x 10 x 7, each 1.19

PAY22177, 11 x 12 x 8, each 1.69

The New NATIONAL HRO

Receiver in stock. Complete with coils, less tubes, speaker and power supply.

PXN13771 . . . \$139.50

NATIONAL COIL FORMS

Type XR 10A, steatite; 2 1/2 x 5"; 26 turns. No. PXN14347 90c

Type XR 12A, steatite; 4 x 6 1/2"; 28 turns. No. PXN14348 1.35

Type XR 20, steatite; 4, 5 or 6 prongs. No. PXN14349 21c

NEW RCA ACR-136

In stock. Get details of this remarkable receiver. Price complete with tubes. Nothing else to buy.

PXN13814 . . \$69.50

Latest RCA OSCILLOGRAPH

Ready for immediate delivery. Complete with tubes. No. PXN13943 \$84.50

Lafayette TRANSMITTING TUBES

Graphite Plates. Real F.B.

203, 211, 242, 845 \$10.95

For FIVE METER HAMS

Two tubes that are the nertz.

800 . . \$7.50 510C, Molly plate \$2.95

866A . . \$2.40 866 \$1.95

A COMPLETE STOCK OF RCA-DeForest — Raytheon — Sylvania X'mitting Tubes at lowest prices.

EIMAC TUBES

at the best prices!

We are sole Distributors for Atlanta and South Eastern States.

PEAK PRESELECTOR

and Preamplifier will boost those R1 sigs to 9. Predates and modernizes your present receiver. Immediate delivery.

No. PXN13760 . . . \$19.80

BLILEY X'TAL HOLDER

20-40 Meter—No. PKN113098 . . \$1.00

80-160 Meter—No. PKN113099 . . \$1.00

BLILEY X'TAL OVEN HOLDER

No. PKN13097 \$7.50

19" RELAY RACKS

Made of higrade steel—not scrap. Black Crystalline finish that will last a lifetime. Entirely new and exceptionally good looking. Drilled every 1 3/4".

3 ft. high—No. PXY22150 . . . \$8.95

6 ft. high—No. PXY22151 . . . \$10.95

Steel Rack Panels 19" Long:

Stock No.	Width	Cost
PXY22160	7"	78c
PXY22161	8 3/4"	95c
PXY22162	10 1/2"	1.15
PXY22163	12 1/4"	1.35
PXY22164	14"	1.55
PXY22165	15 3/4"	1.75
PXY22166	17 1/2"	1.95
PXY22167	19 1/4"	2.10
PXY22168	21"	2.40

TRUTEST CRYSTALS

Accurately ground to .1 of 1%. We will immediately ship frequency nearest to that ordered—or to your specified frequency within 2 days without extra charge. All Xtals are 1-in. square and are guaranteed power oscillators.

X or Y cut

40 meter band, No. PKN3989 . . \$3.75

80-160 m. band, No. PKN13988 \$2.75

AT cut Drift less than 10 cycles per degree per megacycle. 80 and 160 meter band. No. PKN13535 \$3.25

AT cut Drift less than 4 cycles per degree per megacycle. 80 and 160 meter band. No. PKN13536 \$5.00

40 meter band to order only.

No. PKN13537 \$8.50

CARDWELL CONDENSERS

Tank Condensers	Price			
	Type	Cap	Spacing	
PXH8603	164B	220	.070	\$2.35
PXH8604	147B	440	.070	4.12
PXH8605	T-199	330	.084	5.88
PXH8609	T-183	110	.171	5.29
Neut. Condensers				
PXH8611	511-B	23	.171	1.77
PXH8612	513-B	50	.171	3.53
Split Stator				
PXH8616	197B	*80	.070	2.94
PXH8617	157B	*210	.070	4.70

* Per section.

IF YOU DON'T SEE WHAT YOU WANT, ASK FOR IT. We carry the largest and most complete stock of Ham and Experimental parts and equipment in the world.

TRANSFORMERS

A complete line of these in stock:

UNITED TRANSFORMERS

THORDARSON TRANSFORMERS

TRUTEST TRANSFORMERS

Trutest special suppressor grid modulator transformers. From single 45 plate to 1 or 2 RK suppressor grids. No. PXE5498 \$3.75

Same from single 2B6 plate to 1 or 2 RK suppressor grid. A real husky job. Weighs 6 lbs. No. PXE5499 \$3.75

FILAMENT TRANSFORMERS

Primary 115 Volts A.C. 50/60 Cycles

PXE5508 2 1/2 V.C.T. 20 A; 2500 V. insulation \$1.75

PXE5509 7 1/2 V.C.T. 6.5 A; 2500 V. insulation \$1.75

PXE5510 10 V.C.T. 6 3/4 A; 2500 V. insulation \$2.00

PXE5511 6.3 V.C.T. 5 A; 5 V.C.T. 6 A; 2500 V. insulation \$2.00

PXE5512 2 1/2 V.C.T. 12 A; 5000 V. insulation \$1.75

PXE5513 5 V.C.T. 3 A; 5 V.C.T. 3 A; 5 V.C.T. 6 A; 2500 V. insulation \$2.00

PXE5514 Three 7 1/2 V.C.T. 2 1/2 Amp. windings; 2500 V. insulation \$2.00

SMOOTHING CHOKES

PXE5515 12 Henry, 200 MA; D.C. resistance, 140 ohms \$2.50

PXE5516 12 Henry, 300 MA; D.C. resistance, 105 ohms \$3.75

PXE5517 12 Henry, 500 MA; D.C. resistance, 70 ohms \$6.50

INPUT SWINGING CHOKES

PXE5518 5/25 Henry, 200 MA; D.C. resistance, 140 ohms \$2.50

PXE5519 5/25 Henry, 300 MA; D.C. resistance, 105 ohms \$3.75

PXE5520 5/25 Henry, 500 MA; D.C. resistance, 70 ohms \$6.50

PLATE TRANSFORMERS

Primary 115 Volts A.C. 50/60 Cycles

PXE5521 800 each side of center at 150 MA \$3.75

PXE5522 800 each side of center at 250 MA \$5.50

PXE5523 750 or 900 each side of center at 350 MA \$8.50

PXE5524 1250 or 1400 each side of center at 500 MA \$16.00

PXE5525 1600 or 2000 each side of center at 400 MA \$21.75

PXE5526 2500 or 3000 each side of center at 500 MA \$32.50

PXE5527 1250 or 1400 each side of center at 200 MA \$10.00

WHOLESALE RADIO SERVICE CO.

NEW YORK, N.Y. - 100 Sixth Avenue

ATLANTA, GA. 430 W. Peachtree St. NEWARK, N.J. 219 Central Ave.

WHOLESALE RADIO SERVICE COMPANY
100 Sixth Avenue, Dept. P-35
New York, N. Y.

Send me the order I have described in enclosed letter.

Send me your new 136 page BARGAIN BOOK 56-C.

Name _____

Address _____

City _____ State _____

Radio Dealers and Jobbers who desire to advertise in these columns are invited to write for rates.

RADIO BUYERS' GUIDE

A Monthly Listing of Reliable Radio Dealers and Jobbers who solicit the patronage of our readers. Buy from your nearest Dealer or Distributor. He is dependable and reliable.

CHICAGO, ILLINOIS

Chicago Radio Apparatus Company, Inc.

415 South Dearborn Street
Harrison 2276

Dependable Radio Equipment
Established 1921

Bulletins on request—we specialize in short wave transmitting and receiving apparatus.
Catalog Ten cents.

CHICAGO, ILLINOIS

MID-WEST RADIO MART

520 South State Street
CHICAGO

Write for Special Catalog—Free

SCHENECTADY, NEW YORK

ATLANTIC RADIO SUPPLY CO.

712 Broadway

Complete Equipment Stocked for
Service men—Amateurs—Experimenters

Let us quote you

OAKLAND, CALIFORNIA

RADIO SUPPLY CO.

2085 BROADWAY.

Hammarlund, Yaxley, Carter, National, Johnson, IRC, Cardwell, Miller, Morrill, Flechteim, Triplett, Haigis Transceivers
W6GFY

ST. PAUL, MINNESOTA

LEW BONN COMPANY

2484 University Avenue

Rex L. Munger, W9LIP, Sales Engineer

Radio Wholesaler

Complete Stock

BUFFALO, N. Y.

DYMAC RADIO

216 E. Genesee St.

CL 2080

Complete Stock Amateur Parts
STANDARD DISCOUNTS

—W8AWK—

LOS ANGELES, CALIFORNIA

RADIO SUPPLY CO.

912 SO. BROADWAY

The Amateurs'
HEADQUARTERS of the WEST

All Nationally Advertised Parts for
Receiving and Transmitting carried
in stock at all times.

9 Licensed Amateurs on Our Staff



Alden Victron "AA" Condensers



A Victron insulated Variable Condenser, the ideal short-wave condenser, whose PF at RF is only 0.0002. This condenser incorporates outstanding features, not found in any short-wave condenser on the market today: Silver pressure contact on the rotor. No grease or film, or oxide skin as in bearing contacts. Self centering, self tightening cone bearing cannot loosen or produce noise. Minimized metal gives extremely low minimum capacity. Most practically shaped plates for station separation. Soldered brass plates precision spaced. Universal mounting. Double solder tabs on both rotor and stator. Rotor insulated from mounting. Gangs in tandem simply with 1/8-in. Gang-Rod passed through hollow shafts.
Available in maximum capacitances of 15, 50, 100 and 140 mmf.

Alden Universal-Mount Chassis Plugs



The slotted holes will fit any mounting distance from 1 1/2-in. to 1 7/8-in. The prongs are molded in bakelite insulation. Very handy for use on auto-radios, short-wave receivers, amplifiers, etc. Eliminates dangling power supply cables. Plug is dead when connector is removed. Used with standard electrical wall plates for finished off appearance. The slots in the metal flange lock the 924FC series Shielded Connectors.

All-Wave Battery Operated Oscillator



EMBODYING all the features of their A.C.-D.C. operated All-Wave Test Oscillator, the new Model OD Battery Oscillator, just announced by the Clough-Bregle Co. of 1134 W. Austin Ave., Chicago, Ill., meets the needs of many servicemen for rural and auto-radio servicing applications.

The Model OD Test Oscillator is continuously variable from 50 k.c. to 30 m.c. (6000 to 10 meters), all on fundamental output. Extremely large battery capacity is provided to assure long life and consequent low operating cost.

Each instrument is hand calibrated over the entire frequency range and offers three separate outputs: 400-cycle modulated r.f., unmodulated r.f., and 400 cycle audio frequency voltage. A plug-in jack allows external modulation from a phonograph pick-up or variable frequency audio oscillator.

Dual attenuator controls afford unusual range of output, steplessly variable from 1/2 microvolt to 2 volts. Six separate inductor units are contained in a rotating unit to provide the frequency range which covers all short-wave and broadcast receivers and their intermediate frequencies.

Gordon Nameplates



57 VARIETIES of Name Plates for practically every amateur purpose, at 10 cents each, net, are announced by Gordon Specialties Co., 233 East Avenue, Park Ridge, Illinois. The radio constructor will welcome these beautiful, low-priced nameplates.

CHICAGO, ILLINOIS

Chicago Radio Apparatus Company, Inc.

415 South Dearborn Street
Harrison 2276

Dependable Radio Equipment
Established 1921

Bulletins on request—we specialize in short wave transmitting and receiving apparatus.
Catalog Ten cents.

SAN FRANCISCO, CALIFORNIA



1452 Market Street.

"The House of a Million Radio Parts"

Hammarlund and National sets and parts.
Sylvania Amateur Transmitting Tubes

Collins Transmitters.

Arcturus Receiving Tubes.

Trimm Phones, all types.

Johnson Antenna Feeders, Insulators,
Transposition Blocks.

FRESNO, CALIFORNIA

PORTS MANUFACTURING CO.

3265 E. Belmont Ave. Radio W6AVV

National FB7-SW3 and Parts; Hammarlund, Cardwell, Bliley Crystals; Johnson Insulators. Distributors RCA-DeForest Transmitting Tubes
Established 1914 Send for Wholesale Catalog

BUTLER, MISSOURI

HENRY RADIO SHOP

Complete stock of Collins, Patterson, National, Hammarlund, Silver, Cornell-Dubilier, Thordarson, Sylvania, Taylor, Cardwell, Triplett, Bliley, Trimm, Johnson, Turner, and others at lowest wholesale prices. Your used apparatus accepted in trade, too. Write for any information.
211-215 N. MAIN

OAKLAND, CALIFORNIA

ELECTRIC SUPPLY CO.

12th and Fallon Sts.—"Down by the Lake"

40% on Most All Lines

Complete Stock for Amateurs

PATTERSON PR-12—ALL-STAR JR.

Hammarlund and National Sets and Parts

Raytheon Receiving and Transmitting Tubes

W6AZG } Located in } W6IDB
W6DTM } our store } W6KGE

CHICAGO, ILLINOIS

Newark Electric Company

226 W. Madison St.
Chicago

All Kinds of Equipment for
Service Men - Amateurs - Experimenters
Write for free catalog

9 BRAND NEW MODELS

1935's MOST PROFITABLE WORDS

2 TABLE SHELVADORS



Table Shelvador
FR-20—2 cu. ft. NET Capacity. Semi-hermetic Rotary Compressor. Dimensions: 36" high, 23 1/4" wide, 25" deep. (Shown at left). \$79.50

Table Shelvador
FR-30—3.1 cu. ft. NET Capacity. Rotary Compressor. Same dimensions as FR-20. \$94.50

4 SHELVADOR MODELS



Shelvador Model FA-40
4.00 cu. ft. NET Capacity. 8.6 sq. ft. shelf area. 2 ice trays—42 cubes. Dimensions: 52 1/4" high, 23 1/4" wide, 25 1/4" deep. \$112.50

Shelvador Model FA-50
5 cu. ft. NET Capacity. 11.3 sq. ft. shelf area. 2 ice trays—42 cubes—one double-depth tray. Dimensions: 56 1/4" high, 25 1/4" wide, 24 1/4" deep. (Shown at left). \$129.50

Shelvador Model FA-60
6 cu. ft. NET Capacity. 13.5 sq. ft. shelf area. 3 ice trays—63 cubes—one double-depth tray. Dimensions: 56 1/4" high, 30 3/4" wide, 25 1/4" deep. \$149.50

Shelvador Model FA-70
7.08 cu. ft. NET Capacity. 14.9 sq. ft. shelf area. 4 ice trays—84 cubes—one double-depth tray. Dimensions: 57 1/4" high, 32 1/4" wide, 25 1/4" deep. \$169.50

3 TRI-SHELVADOR MODELS



Models FA-50, FA-60, FA-70 and all Tri-Shelvador Models also available with porcelain exterior at slight extra cost.

Tri-Shelvador Model F-43
4.3 cu. ft. NET Capacity. 9.15 sq. ft. shelf area. 2 ice trays—42 cubes—one double-depth tray. Dimensions: 56-9/16" high, 23 1/4" wide, 23 1/4" deep. \$139.50

Tri-Shelvador Model F-55
5.51 cu. ft. NET Capacity. 11.6 sq. ft. shelf area. 3 ice trays—63 cubes—one double-depth tray. Dimensions: 57 1/4" high, 29" wide, 24 1/4" deep. \$164.50

Tri-Shelvador Model F-70
7.08 cu. ft. NET Capacity. 14.9 sq. ft. shelf area. 4 ice trays—84 cubes—one double-depth tray. Dimensions: 58 1/4" high, 32 1/4" wide, 25 1/4" deep. (Shown at left). \$189.50

Crosley Tri-Shelvador Adds 3 Exclusive Features to Famous Shelvador

The Tri-Shelvador has all the features of the Shelvador, with the following added exclusive features:

- 1—SHELVATRAY. Handy shelf in door that drops to horizontal position. Place articles on Shelvatray and carry them (Shelvatray and all) to table, range, or cabinet. Saves time and steps. (Patent Pending.)
- 2—SHELVABASKET. A non-refrigerated basket on bottom of door for greens, carrots, cabbages and the like. An exclusive feature. (Patent Pending.)
- 3—STORABIN. A non-refrigerated bin in bottom part of cabinet for potatoes, onions, and other bulk items. Found only in Tri-Shelvador. (Patent Pending.)

In addition: Self-closing stainless steel door to freezing chamber in all Tri-Shelvador Models.

EXCLUSIVELY IN

CROSLEY

ELECTRIC REFRIGERATORS



This much more in a Shelvador

THIS much more . . . twice as easy to find . . . the all-time high-point in electric refrigerator convenience . . . smartness that excites exclamations everywhere! No wonder sales are going up! up! UP! Shelvador—the electric refrigerator showing the greatest sales growth during 1934—will make new sales history during 1935. For SALES are written all over these amazing models that meet every viewpoint, every purse.

When you sell EXCLUSIVE features, you sell something beyond the reach of competition. And the 1935 Crosley line is exclusive, not only in features, but in Streamline Beauty and in foot-saving convenience. Far ahead in value. The prices speak for themselves. Get in touch with your Crosley distributor, so that you may begin now to make 1935 your biggest year. You can't afford NOT to handle Crosley.

THE CROSLEY RADIO CORPORATION

(Pioneer Manufacturers of Radio Receiving Sets)
Home of WLW—the world's most powerful broadcasting station.
POWEL CROSLEY, Jr., President CINCINNATI
Western prices slightly higher.

ALL PRICES INCLUDE DELIVERY..INSTALLATION..ONE YEAR FREE SERVICE



The Answer to Your Modulation Choke Problem A Universal Choke for Every Purpose

What This
Universal
Modulation
Choke
Will Do:



It is tapped so that it can be used as an autotransformer coupler from Class B to Class C stages; various impedance taps are available so that each choke will readily accommodate push pull Class A-Prime or Class B Modulators, single ended Class A Modulator with the DC adding, or single ended Class A Modulator with the DC bucking.

The chokes are huskily constructed and air gaps are arranged to take care of the maximum DC currents.

Broadcast and phone men who want an output audio unit that will match all possible tube impedance combinations to the RF Stage cannot afford to be without the new UTC Universal Modulation Output Chokes.

TYPE		LIST PRICE	NET TO HAMS
HUC-20	Will handle 20 watts audio power. Can be used with class B 46's, 59's, 53, 6A6, 79, etc., or class A 2A3's, class A prime 42's, 45's, etc.	\$7.00	\$4.20
HUC-50	Will handle 50 watts audio power. Suitable for use with class B 210's, 801's, 830's, 841's, push pull parallel 46's or 59's, push pull parallel 45's A prime, push pull parallel 2A3's.	\$12.50	\$7.50
HUC-100	Will handle 100 watts audio power. Suitable for use with class B 800's, 211E's, A prime 284's, 845's, etc.	\$20.00	\$12.00
HUC-200	Will handle 200 watts audio power. Suitable for use with class B 203's, 830B's, HK-354's, single EIMAC 150T, push pull parallel 845's, prime, etc.	\$32.50	\$19.50
HUC-500	Will handle 500 watts audio power. Suitable for use with class B 204's, HK354's, EIMAC 150T's, A prime 212D's, A prime 849's, etc.	\$80.00	\$48.00

Complete circuit matching dots furnished with each unit.

UTC Transmitting Components

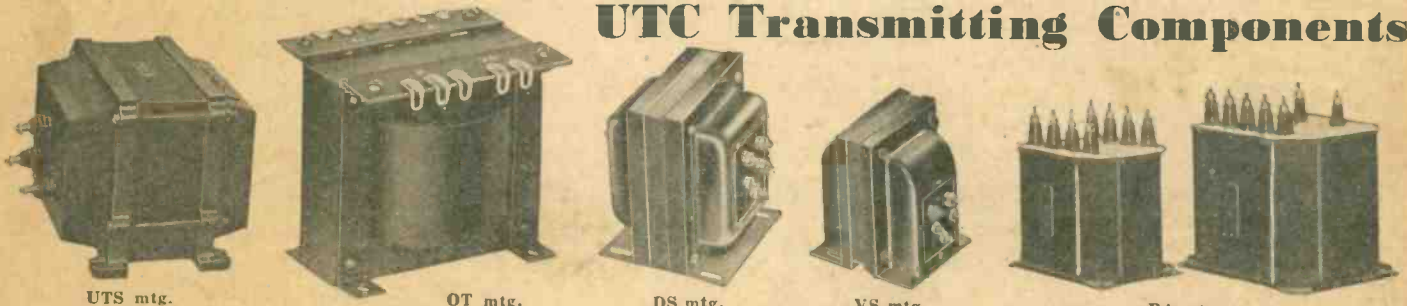

UTS mtg.

OT mtg.

DS mtg.

VS mtg.

PA mtgs.

The transmitting type of UTC plate, filament and filter components have been developed for and are used widely by Commercial Telephone, Telegraph, Communication and Broadcast systems. They are particularly well adapted for use in AMATEUR TRANSMITTER applications. All units are fully enclosed in cases having a professional appearance when grouped in finished equipment. Plate transformers housed in the UTS or PA type shields are fully impregnated and sealed with a special heat dissipating compound. The units are specifically treated to withstand adverse climatic conditions in any part of the Globe.

PLATE TRANSFORMERS, PRIMARY 115 VOLTS A.C. 50/60 CYCLES

VS-10	450 each side of center at 150 MA; 5V-3A; 2½V-10A. VS mtg.	LIST PRICE \$ 6.50
DS-2	500 each side of center at 200 MA; 2½ V.C.T. 14 A; 5 V.C.T. 3 A; DS mtg.	8.00
DS-3	600 each side of center at 200 MA; 2½V-10A; 7½V-3A 5V-3A, DS mtg.	10.00
DS-4	800 each side of center at 150 MA; DS mtg.	7.50
DS-5	800 each side of center at 250 MA; DS mtg.	11.00
PA-111X	750 or 900 each side of center at 350 MA; PA mtg.	17.00
PA-112X	1250 or 1400 each side of center at 500 MA; PA mtg.	32.00
PA-113X	1600 or 2000 each side of center at 400 MA; PA mtg.	43.50
PA-114X	2500 or 3000 each side of center at 500 MA; UTS mtg.	65.00
PA-116X	1250 or 1400 each side of center at 200 MA; PA mtg.	20.00

SMOOTHING CHOKES

VS-1	12 Henry, 200 MA; D.C. resistance 140 ohms. VS mtg.	\$ 5.00
DS-30	12 Henry, 300 MA; D.C. resistance 105 ohms. DS mtg.	7.50
DS-50	12 Henry, 500 MA; D.C. resistance 70 ohms. DS mtg.	13.00

INPUT SWINGING CHOKES

VS-2	5/25 Henry, 200 MA; D.C. resistance 140 ohms. VS mtg.	\$ 5.00
DS-40	5/25 Henry, 300 MA; D.C. resistance 105 ohms. DS mtg.	7.50
DS-60	5/25 Henry, 500 MA; D.C. resistance 70 ohms. DS mtg.	13.00

FILAMENT TRANSFORMERS, PRIMARY 115 VOLTS A.C. 50/60 CYCLES

DS-12	2½ V.C.T. 20 A; 6 V.C.T. 3 A; 7½ V.C.T. 6½ A. 2500 V. insulation. DS mtg.	LIST PRICE \$ 8.50
DS-13	10 V.C.T. 6½ A; 10 V.C.T. 6½ A; 7½ V.C.T. 2½ A; 2½ V.C.T. 5 A; 2500 V. insulation. DS mtg.	11.50
DS-14	11 V.C.T. tapped at 12 and 14 volts at 10 A. 5000 V insulation. DS mtg.	8.50
DS-15	2½ V.C.T. 12 A; 5000 V. insulation; 10 V.C.T. 6½ A, DS mtg.	8.00
DS-16	5 V.C.T. 20 A; 7000 V. insulation. DS mtg.	7.50
DS-17	5 V.C.T. 20 A; 10,000 V. insulation. DS mtg.	10.00
VS-12	2½ V.C.T. 12 A; 7000 V. insulation. VS mtg.	4.50
VS-13	7½ V.C.T. 6½ A; 5000 V. insulation. VS mtg.	4.50
VS-14	10 V.C.T. 6½ A; 5000 V. insulation. VS mtg.	4.50
VS-15	5 V.C.T. 3 A; 5 V.C.T. 3 A; 5 V.C.T. 6 A; 5000 V. insulation. VS mtg.	5.00
OT-1	2½ V.C.T. 20 A; 2500 V. insulation. OT mtg.	3.00
OT-2	7½ V.C.T. 6.5 A; 2500 V. insulation. OT mtg.	3.50
OT-3	10 V.C.T. 6½ A; 2500 V. insulation. OT mtg.	4.00
OT-4	6.3 V.C.T. 5 A; 5 V.C.T. 6 A; 2500 V. insulation. OT mtg.	4.00
OT-5	2½ V.C.T. 12 A; 5000 V. insulation. OT mtg.	3.50
OT-6	5 V.C.T. 3 A; 5 V.C.T. 3 A; 5 V.C.T. 6 A; 2500 V. insulation. OT mtg.	4.00
OT-7	Three 7½ V.C.T. 2½ Amp. windings; 2500 V. insulation OT mtg.	4.00

Standard 40% Discount to Amateurs on Above Prices
UNITED TRANSFORMER CORP.

264-266 CANAL STREET

Export Division, 15 Laight St., New York, N. Y.

NEW YORK, N. Y.

Exclusive UTC distributors carrying a complete stock of UTC products.

Goldamer's, Inc.	610 Huron Road, Cleveland, Ohio	Cameradio Company	603 Grant Street, Pittsburgh, Pa.
Wholesale Radio Service Co., Inc.	100 Sixth Ave., New York, N. Y.	W. H. Edwards & Co.	32 Bway, Providence, R. I.
Wholesale Radio Service Co., Inc.	219 Central Ave., Newark, N. J.	SEATTLE, WASH.—Seattle Radio Supply, Inc.	2319 Second Ave.
Wholesale Radio Service, Inc.	430 W. Peachtree St. N. W., Atlanta, Ga.	Portland Radio Supply Co.	1300 W. Burnside, Portland, Ore.
Sun Radio	227 Fulton Street, New York, N. Y.	Spokane Radio Co., Inc.	611 First Ave., Spokane, Wash.
Gross Radio, Inc.	51 Vesey Street, New York City	San Francisco Radio Exchange	1284 Market St., San Francisco, Calif.
Leeds	45 Vesey Street, New York City		
William Gram	1444 Sheridan St., Lansing, Mich.		
Mohawk Electric Co.	1335 State St., Schenectady, N. Y.		
Walter Ashe	1100 Pine St., St. Louis, Mo.		
Radio Shack	46 Brattle St., Boston, Mass.		
Nutter & Cross	900 Milk St., Boston, Mass.		
Radio Service Lab. of N. H.	1008 Elm St., Manchester, New Hampshire		
Hatry & Young	203 Ann St., Hartford, Conn.		

SOUTHERN CALIFORNIA

Pacific Radio Exchange Inc.	729 S. Main St., Los Angeles
Radio Supply Co.	912-14 S. Broadway, Los Angeles
Coast Electric Co.	744 G. St., San Diego
Prest & Dean Radio Co.	400 American Avenue, Long Beach
Radio Television Supply Co.	1701 S. Grand Ave., Los Angeles, Calif.
Radio Specialties Co.	1816 West 8th St., Los Angeles, Calif.